

EXAMPLE OF BASE PLATE FIXTURE

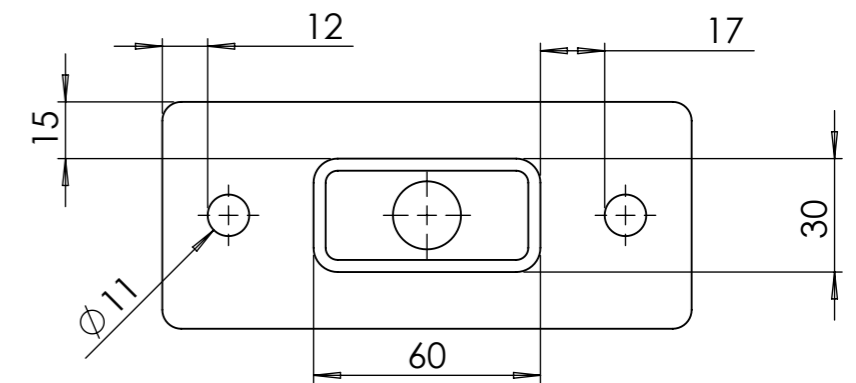

FITTING DETAILS

- 1) PRE DRILLED FOR VENTING & DRAINAGE
- 2) MAXIMUM RECTANGULAR HOLLOW SECTION 60mm x 30mm
- 3) FOR USE WITH M10 BOLTS & WASHERS

		FH BRUNDLE Tel: 01708 253545 Email: sales@brundle.com Web: www.fhbrundle.co.uk		NOTES: Customer Information Drawing	
		MATERIAL: Plain Carbon Steel		DESCRIPTION: Rectangular Base Plate 140 x 60 x 6 With Ø11 Holes	
FINISH: Self Colour		PART NO: 2002140606		DWG NO: 0008-002-003	
GRIT SIZE: N/A		WEIGHT: 0.37 Kg		SCALE: 1:1	
UNLESS OTHERWISE SPECIFIED ALL DIMENSIONS ARE IN MILLIMETERS		NAME: GC DATE: 26/07/2016 REVISION: A		DO NOT SCALE DRAWING	
DRAWN: GC		REV. BY:		SHEET 1 OF 1	