



F.H. BRUNDLE
SERVING THE TRADE SINCE 1889

Product Information & CAD Drawings

As always at F.H. Brundle we try to help and support our customers in any way we can. In our efforts to help our customers, we will make our drawings available to use free of charge. At the present time, unfortunately, we do not have drawings available for all our products, but we will continually add more, offered in a wider variety of formats, as they become available. To check if we have a drawing available, simply find the product on our website and look for the appropriate symbols as indicated here.

Size information

Many of our products will have a pdf available which offers key product information, including dimensions. Look for PDF icon under the 'Technical Drawings' heading as highlighted below.

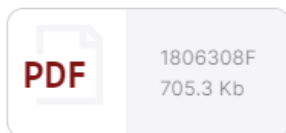

Handrail Wall Support Bracket 42.4mm Fix 42.4mm Mounting Adj. Spigot

SPECIFICATIONS
Diameter: 42.4mm
Wall/tube
25mm distance from wall to centre of bracket
Material: stainless steel 316
Finish: satin

CODE
1806308FC

CATALOGUE INFORMATION
539 [Request copy](#)

WEIGHT
.21 kg

PRICE
~~£9.00~~ **£7.30** EACH Ex VAT @ 20%

1 [Add to basket](#)

We have item in the following alternatives;

CHOOSE YOUR VARIANTS

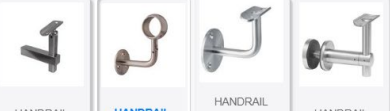

Technical Drawings

	1806308F 78.2 Kb		1806308F 705.3 Kb		1806308F 456.8 Kb
--	---------------------	--	----------------------	--	----------------------

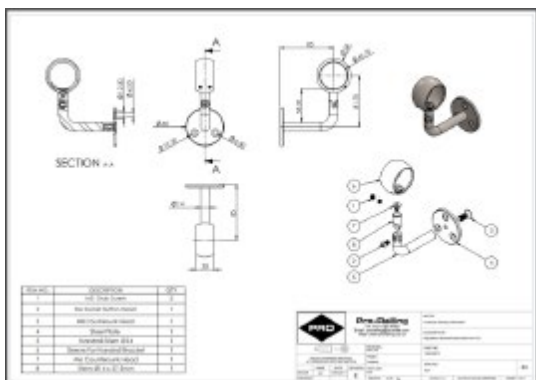

Safety Information

If we have product safety information available, a PDF icon will be visible under the 'Safety Datasheet' heading, as highlighted below. This may be offered in different formats, and can include test reports.

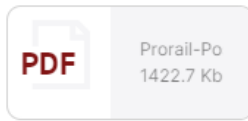

Home > Handrailing & Balustrade > Handrail Components > Handrail Saddle Bracket



PRODUCT INFORMATION
Handrail Saddle Bracket 42.4mm Fix 42.4mm Mounting Adj Spigot

SPECIFICATIONS
Diameter: 42.4mm
Adjustable angle

Material: stainless steel 304
Finish: satin

CODE: 1804312CC
CATALOGUE INFORMATION: 540 [Request copy](#)

WEIGHT: .21 kg

PRICE: ~~£ 7.30~~ £ 6.50 EACH Ex VAT @ 20%

1 [Add to basket](#)

Safety Datasheet
PDF Prorail-Po 1422.7 Kb

CAD Downloads

Please note: It is important to read the below CAD downloads disclaimer, as terms and conditions apply to using our free downloads.

We have a wide range of 2D and 3D .dwg and .stp downloads available. Look for the symbols under 'Technical Drawings' as indicated below. If the product doesn't show this symbol, it means no drawing is currently available. We will, however, continue to add them, as soon as they become available.



Handrail Wall Support Bracket 42.4mm Fix 42.4mm Mounting Adj. Spigot

SPECIFICATIONS
Diameter: 42.4mm
Wall/tube
85mm distance from wall to centre of bracket
Material: stainless steel 316
Finish: satin

CODE: 1806308FC
CATALOGUE INFORMATION: 539 [Request copy](#)

WEIGHT: .21 kg

PRICE: ~~£ 9.00~~ £ 7.30 EACH Ex VAT @ 20%

1 [Add to basket](#)

We have item in the following alternatives;

CHOOSE YOUR VARIANTS

Technical Drawings
DWG 1806308F 78.2 Kb PDF 1806308F 705.3 Kb STP 1806308F 456.8 Kb

3D Downloads

Our drawing office uses Solid Works. Many of our Pro-Railing parts are drawn in Solid Works and are currently available upon request. In time, these will also be made available on our website, but if you require them sooner, please email designstudio@brundle.com and we will help if we can. Please provide your details and your preferred file format. Please note that, although our aim is to have drawings available for all parts in the future, this will take time to achieve.

CAD Drawing Disclaimer

All intellectual property rights (including, without limitation, all copyright and design rights) subsisting in the CAD drawings and related information belongs to F.H. Brundle (or to our suppliers when provided with their permission).

The USER may not, use or allow the use of, F.H. Brundle CAD drawings for any product or system other than products or systems provided by F.H. Brundle under any circumstances.

The reproduction and use of this material is only authorised for purposes connected with the specification or use of F.H. Brundle products and systems. The USER of this information is authorised to reproduce and distribute exact copies or exact extracts of CAD drawings for the sole purpose of detailing, specifying, using, and promoting the use of F.H. Brundle products and systems. Details may not be changed under any circumstance.

Please note that these drawings and information may not contain the full details required for manufacture.

It is the USER's responsibility to ensure that the USER or installer complies with any EU/BS building performance requirements and to ensure specification and installation of products and systems are safe, compliant and are in accordance with all applicable regulations. Appropriate expert advice should always be obtained to ensure suitability of these drawings for your specific application. F.H. Brundle recommends that the USER consults a structural engineer whenever necessary.

FH Brundle cannot be held liable for the compliance of our products to Building Regulations and it remains the responsibility of the customer to ensure all regulations are met.

We continually develop and improve our products and systems therefore F.H. Brundle reserves the right to amend or discontinue our products from time to time as necessary. The USER should always check availability and always use the latest drawings provided online.

F.H. Brundle accepts no responsibility or liability for any loss or damage caused to the USER or any third party through any use of the CAD drawings or related information, which use contravenes these terms of use, including but not limited to, any use of the CAD drawings and related information:

- a) with any product or system other than F.H. Brundle products or systems.
- b) where the CAD drawings and related information are modified in any way.

The USER is deemed to accept these terms of use. IF YOU DO NOT AGREE TO THE TERMS OF USE, DO NOT USE THE F.H. BRUNDLE CAD DRAWINGS.