











Colour Guide

The colours in the tables will help you select your products material and finish. These will also be displayed in the page footer throughout this section. Products not colour coded will state their material or finish below the table.

	Grade 304 Stainless steel (Internal)
	Grade 316 Stainless steel (External)
	Zamac (Zinc aluminium alloy)
	Zinc coated steel
	Mild steel
	Galvanised steel
	Aluminium
	Duplex 2205 (Ultra marine stainless)

Icons

Throughout this section there are various icons to help you with your product selection.

	Diameter
	Square Solid
	Rectangular Solid
	Square Hollow
	Rectangular Hollow
	Technical information that can be found on our website
	Handy tip for quicker and more effortless installation
	Download our made-to-order form online
	High risk product, please read our warning note below
	Scan for more information

Fencing



WARNING

WE ARE ADVISED THAT NORMAL & PROPER USE OF THIS PRODUCT DOES NOT AMOUNT TO A CRIMINAL OFFENCE

So far as civil liability is concerned, customers are entitled to take reasonable precautions to protect their property, provided they do not set out to use a hidden trap for such purpose.

1. Ensure that all security products are located in a prominent position so that it can be seen by any person approaching; eg. on top of an existing fence, wall or roof, or inside an outer fence. 2. Display a warning sign (code: **490015**) supplied by F.H. Brundle. 3. Ensure that warning signs are visible at night.

By adopting the above approach, our customers should avoid all possibility of legal action in the event of personal injury. However, it is the responsibility of the customer to ensure that the use to which the product is put does not infringe the criminal or civil law, and F.H. Brundle cannot accept any liability in the event of such infringement.

Index

- Aluminium Fencing..... 602-616
- Aluminium Made To Order Gates..... 600-601
- Aluminium Railings..... 618
- Anti-Vandal Scaling Barrier (AVSB)..... 684-687
- Armco Barrier..... 694-698
- Barbed Wire & Tape..... 689-690
- Barrier Fencing..... 647
- Bekafix® Post System..... 662
- Betafence Mesh Clips..... 673
- Betafence Systems..... 652-661
- Bollards & Site Protection..... 699-701
- Bow Top Fencing & Gates..... 626-633
- Chain & Fittings..... 702
- Chain Link Fencing..... 644-645
- Chestnut Pale Fencing..... 642
- Column Protectors..... 703
- Composite Fencing..... 590-595
- Corner Guard..... 699
- Crash Barrier Posts, Ends & Corners..... 694-698
- Debris Netting..... 650
- Expanded Metal (AVSB)..... 686
- Expanded Metal Fencing..... 674
- Fence & Gate Infill Boards..... 594-597
- Fencing Pin Bars..... 647
- Fortitude™ Railings & Gates..... 634-641
 - Bow Top..... 626-633
 - Estate..... 621-625
 - Flame..... 639
 - Fleur de Lis..... 637
 - Forest..... 638
 - Parkland..... 619-620
 - RoSPA Bow Top..... 626-627
 - Sphere Top..... 635
 - Vertical Bar..... 636
 - Wall Top Railings..... 641
- Gabion Fencing System..... 643
- Gate Infill Boards..... 594-597
- GRP Palisade Fencing & Gates..... 682-683
- Heras Fencing..... 649-650
- Kingspan Fencing..... 592-593
- Make Your Own
 - Bollards..... 701
 - Bow Tops..... 628
 - Mesh Gates..... 672
 - Palisade Gates..... 680
- Marano® Aluminium Fencing..... 602-616
- Marano® Made To Order Gates..... 600-601
- Marano® Original Aluminium Fencing..... 602-608
- Marano® Integrated Aluminium Fencing..... 610-616
- Mesh Fencing & Gates...
 - Fencing Clips..... 673
 - Gates..... 663-672
 - Gates 358..... 669
 - Gates 656..... 663-664
 - Gate Clamp Bar Kits..... 672
 - Meshmaster™ 358..... 667-669
 - Site Gates..... 651
- Nylofor® 2-D..... 656-657
- Nylofor® 3-D..... 654-655
- Nylofor® 3-D Pro XL..... 652-653
- Nylofor® 3-M..... 652-653
- Paladin® Classic..... 658-659
- Privacy Roll..... 653
- Securifor® 358..... 665-666
- Roll Top®..... 660-661
- Twilfix® 2000 System..... 653
- Palisade Fencing & Gates..... 675-681
- Palisafe® GRP Palisade.. 682-683
- Parking Posts..... 700
- Pedestrian Barrier..... 692
- Polymer
 - Fencing..... 596-598
 - Fencing Pales..... 617
 - Profiles..... 617
- Polyurethane Fence Panels..... 592-593
- Post Protectors..... 703
- Privacy Roll..... 653
- Raptor (AVSB)..... 687
- Rinato™ WPC & Polymer Fencing..... 594-598
- Rinato™ Prestige Cladding..... 590-591
- RoSPA Bow Top Railings & Gates..... 626-627
- Safety Barriers & Post Protection..... 703
- Security & Wall Spikes..... 688
- Security Fencing Rolls..... 646
- Security Mesh Fencing..... 647
- Site Gates..... 651
- Spin Guard (AVSB)..... 684-685
- Stock Fencing..... 646
- Temporary Mesh Fencing..... 649-650
- Tools & Clips..... 648
- Vehicle Barriers..... 693
- Wall Spikes..... 688
- Wire..... 691
- WPC Cladding..... 590-591
- WPC Fencing..... 594-595
- WPC Made To Order Gates..... 600-601
- Zenturo® Super Gabion Fencing..... 643

Fencing
website section



Prestige Cladding



- Steel
- Wrought Iron
- Gate Hardware
- Sliding Door Gear
- Gate Automation
- Mesh
- Decking & Subframe
- Flooring & Stair Treads
- Handrailing
- Fencing
- Fixings



Our WPC cladding boards utilise the same advanced co-extrusion technology as our Natural range of deck boards. The cladding looks completely natural, is low maintenance and easy to clean, unlike timber cladding. The boards are UV resistant and will not fade, keeping their stylish colours for years to come. It is important to allow for the expansion and contraction of the boards in different temperatures. We recommend that batons are used to support the cladding every 500mm.

Features:

- Available in 3 colours
- Contemporary embossed wood effect boards
- Boards are UV resistant and will not fade
- Made from eco-friendly FSC certified wood
- Boards can be installed vertically or horizontally, using our clever hidden fixing system
- Full range of trims to allow for the system to be installed on any wall

Antique



L x H x T mm	Code
3600 x 140 x 13	73A001

Charcoal



L x H x T mm	Code
3600 x 140 x 13	73CH001

Walnut



L x H x T mm	Code
3600 x 140 x 13	73W001

In-Line Joint Trim



Colour	H x W x D mm	Code
Antique	3600 x 79 x 26	73A002

In-Line Joint Trim



Colour	H x W x D mm	Code
Charcoal	3600 x 79 x 26	73CH002

In-Line Joint Trim



Colour	H x W x D mm	Code
Walnut	3600 x 79 x 26	73W002

Cladding End Trim



Colour	H x W x D mm	Code
Antique	3600 x 47 x 45	73A003

Cladding End Trim



Colour	H x W x D mm	Code
Charcoal	3600 x 47 x 45	73CH003

Cladding End Trim



Colour	H x W x D mm	Code
Walnut	3600 x 47 x 45	73W003

Board expansion rates can be found online.

Cladding Angle Trim



Colour	L x H x T mm	Code
Antique	3600 x 55 x 55	73A004

Cladding Angle Trim



Colour	L x H x T mm	Code
Charcoal	3600 x 55 x 55	73CH004

Cladding Angle Trim



Colour	L x H x T mm	Code
Walnut	3600 x 55 x 55	73W004

Finishing Board



Colour	L x H x T mm	Code
Antique	3600 x 70 x 10	73A005

Finishing Board



Colour	L x H x T mm	Code
Charcoal	3600 x 70 x 10	73CH005

Finishing Board



Colour	L x H x T mm	Code
Walnut	3600 x 70 x 10	73W005

Clips & Screws Pack



Description	Code
100 Screws & 100 Clips	73SS001

Image of enhanced woodgrain finish



Application image showing the boards installed on a corner



Make Life Easier With Online Ordering!

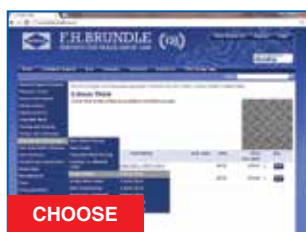

- Order products 24/7
- Check prices
- View purchase history
- Create quotes

Visit www.fhbrundle.co.uk

Kingspan Fencing

High quality, sleek modular fencing system



- Steel
- Wrought Iron
- Gate Hardware
- Sliding Door Gear
- Gate Automation
- Mesh
- Decking & Subframe
- Flooring & Stair Treads
- Handrailing
- Fencing
- Fixings



This new to the market, innovative fencing solution from Kingspan offers a high-quality, long lasting, stylish fence. The system is built using the recognised Kingspan sandwich panels, that were traditionally used for cladding buildings and roofs. This lightweight, easy to handle panel only requires posts every 2.5m, meaning far less groundwork is required than alternative composite solutions.

- Aluminium posts, post tops & finishing profile
- Anthracite Deep Matt RAL 7016
- Wind pressure tested to 120km/h
- Polyurethane double-sided panels - smooth one side & ribbed on the other
- Low maintenance and corrosion and UV tested
- Lightweight & quick installation
- Concrete-in or bolt down option
- Robust durable coating allows panels to be used up to 1km from the coast

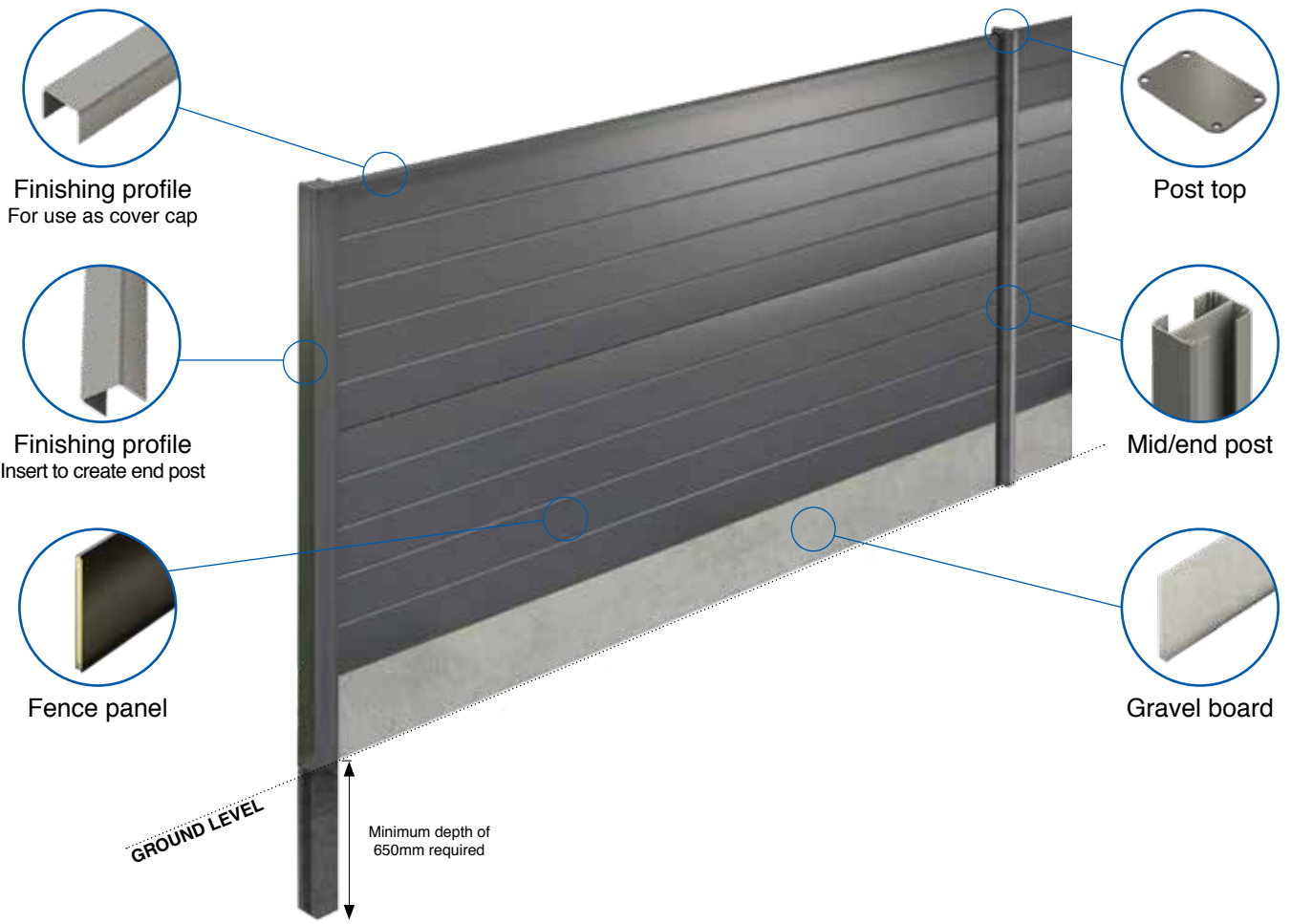

Double-Sided Panel



L x H x T mm	Code
2500 x 488 x 39	61S001488A
2500 x 610 x 39	61S001610A

The panels feature a rigid PUR (polyurethane) foam with a density of 45 kg/m³. They have been successfully wind pressure tested to 120 km/h and are anti-corrosion and UV tested and approved.

Mid / End Post

Bolt-down or concrete-in



Colour	Fence Height m	H x W x D mm	Code
Grey	1.8	2750 x 100 x 65	61PCM18A

The posts have been specially designed to make installation of the system even easier. When creating an end post use finishing profile code: **61S001CA** as an insert to neatly close off one end.

Corner Post

Bolt-down or concrete-in



Colour	Fence Height m	H x W x D mm	Code
Grey	1.8	2750 x 100 x 65	61PCC18A

The posts have been specially designed to make installation of the system even easier.

Concrete Gravel Board



L x H x T mm	Code
2500 x 300 x 35	61GB30

Weight per board 66kg. Provides the base for the fence system. Panels are installed directly onto the gravel boards.

Finishing Profile

For panels & end posts



Length mm	Code
2450	61S001CA

Aluminium profiles provide the finishing touch to the fencing system.

Post Top



Size mm	Code
100 x 65	61PT01A

Supplied with screws.

Base Plate



Size mm	Code
120 x 120 x 6	61BPA



You can order online 24 hours a day, 7 days a week. Visit our website: www.fhbrundle.co.uk

Rinato™ WPC Fencing

The look of wood without the hassle



Our Rinato WPC fencing system looks amazing and is both easy to use and cost effective. It will also enhance any garden and create a contemporary focal point. This versatile recycled composite system is an eco-friendly product made from combining waste wood particles and thermoplastic resin. It is waterproof, strong and easy to maintain. We have bolt-down and concrete-in aluminium post options, and if you would like to use our WPC fencing between your existing concrete posts we have inserts to fit them. We have four great colours to choose from.

- Long-lasting & low maintenance
- Available in 4 colours - Birch, Chestnut, Ebony & Twilight Grey
- Standard fence height 1.8m with 1.8m post centres
- Aluminium concrete-in or bolt-down post options available
- Posts & boards can be cut to create a lower or narrower fence
- No more frost damaged, cracked or chipped concrete posts
- Panels are built quickly using tongue & groove boards
- Easy to carry & deliver; much lighter than concrete posts
- Recycled, eco-friendly FSC® certified wood
- Wall mounted post / insert available for pre-existing posts

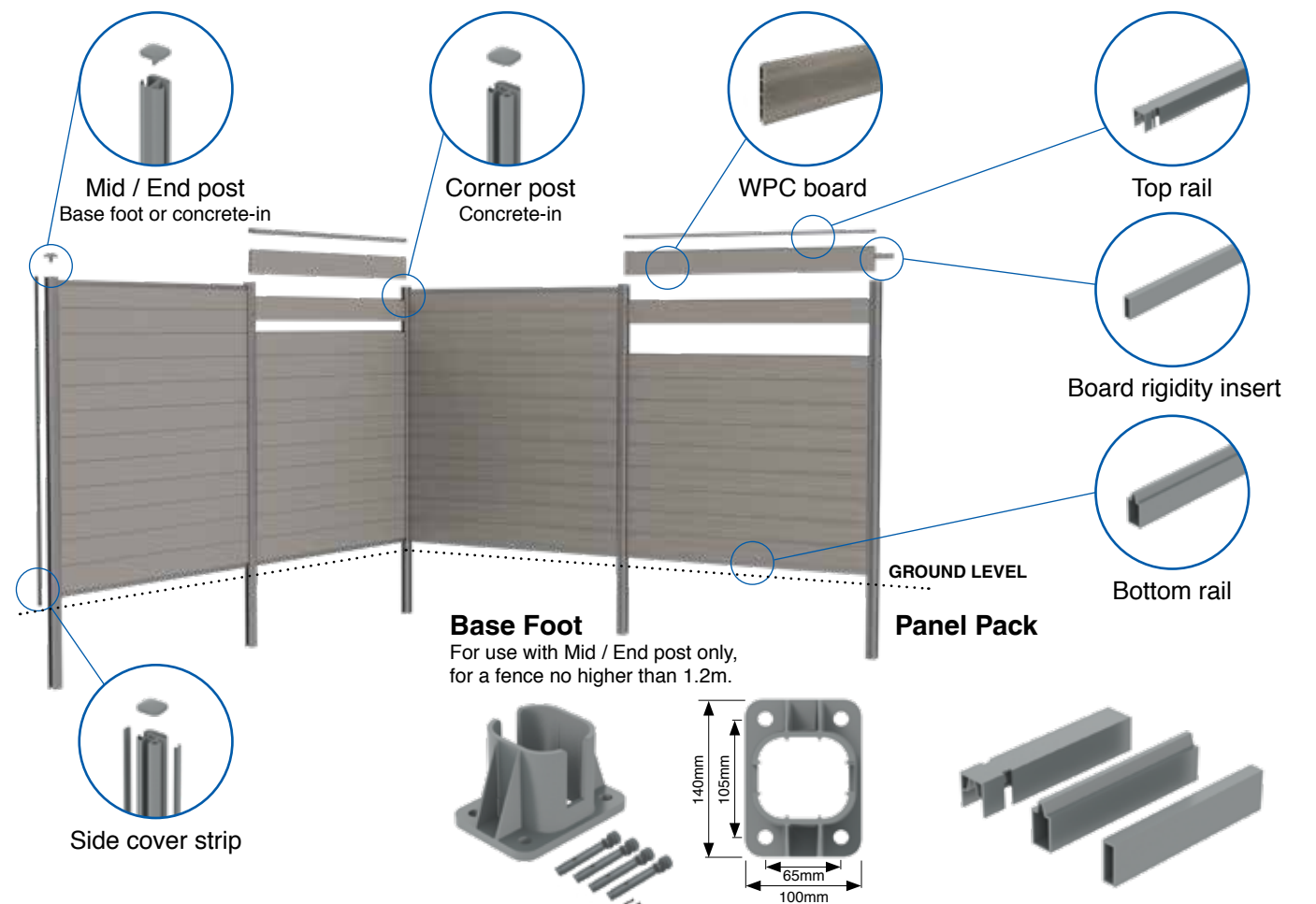

Scan here for the acoustic test results & installation guide.



Colour	H x W x D mm	Code
Grey	90 x 100 x 140	72BFG

Includes 2 x screws and 4 x anchor sleeves. Aluminium PPC RAL 7012.

Colour	Code
Grey	72FPR18G

Includes 1 x top rail, 1 x bottom rail and 3 x board rigidity inserts. Aluminium PPC RAL 7012.

Price per metre run with concrete-in mid / end posts

Birch

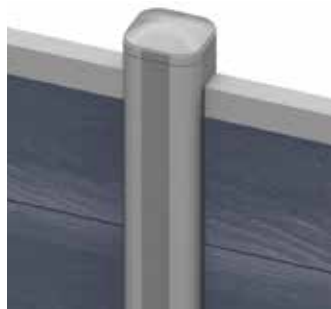

Fence Height m	Code
1.8	72FP18BM

Chestnut

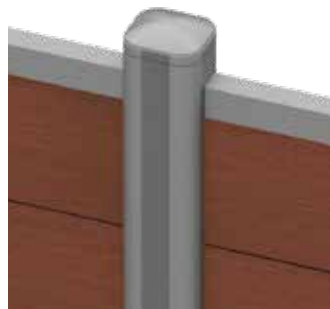

Fence Height m	Code
1.8	72FP18CM

Ebony



Fence Height m	Code
1.8	72FP18EM

Twilight Grey

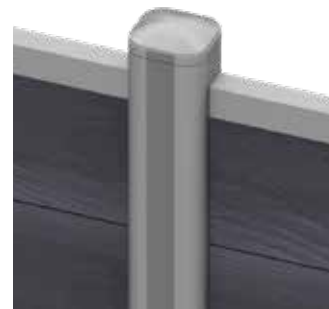

Fence Height m	Code
1.8	72FP18TGM

Metre price includes concrete in posts, WPC boards and panel pack. Please add any additional corner or end posts required to the order.

Boards Only - supplied in packs of 6

Birch



L x H x T mm	Code
1783 x 150* x 21	72FPS18B

Chestnut



L x H x T mm	Code
1783 x 150* x 21	72FPS18C

Ebony



L x H x T mm	Code
1783 x 150* x 21	72FPS18E

Twilight Grey



L x H x T mm	Code
1783 x 150* x 21	72FPS18TG

Includes 6 x boards per pack. *Overall height 159mm; to the shoulder 150mm.

Mid / End Post

Bolt-down or concrete-in



Colour	Fence Height m	H x W x D mm	Code
Grey	1.8	2400 x 73 x 66	72PC18iG

Includes 1 x post cap with screw, 2 x plastic height setting pieces with 2 x screws, 1 x long side cover strip & 2 x short side cover strips. Aluminium PPC RAL 7012.

Corner Post

Concrete-in

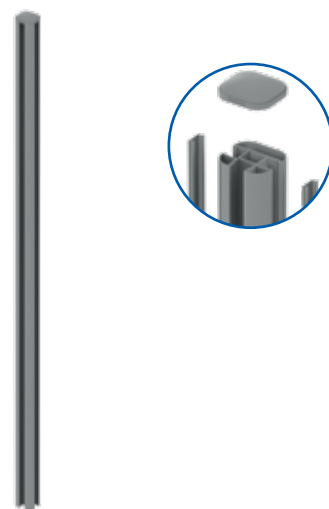

Colour	Fence Height m	H x W x D mm	Code
Grey	1.8	2400 x 73 x 66	72PC18CG

Includes 1 x post cap, 1 x long side cover strip and 2 x short side cover strips. Aluminium PPC RAL 7012.

Wall Mounted Post / Insert

For use with pre-existing concrete post or wall mounting.

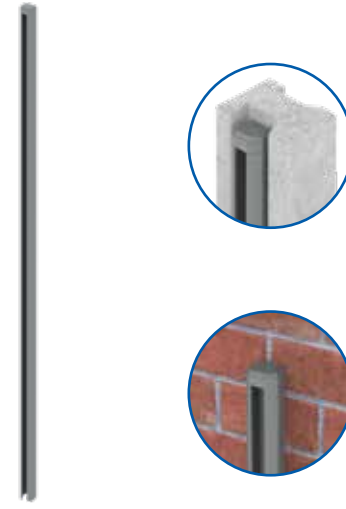

Colour	Fence Height m	H x W x D mm	Code
Grey	1.8	1905 x 48 x 40	72Pi18G

Includes 1 x post cap and 2 x post cap screws. Fix with screws & plugs or glue, depending on your posts and preference. Aluminium PPC RAL 7012.

Board expansion rates can be found online.

Rinato™ Polymer Fencing



The look of wood without the hassle

- Steel
- Wrought Iron Components
- Gate Hardware
- Sliding Door Gear
- Gate Automation
- Mesh
- Decking & Subframe
- Flooring & Stair Treads
- Handrailing
- Fencing
- Fixings



Experience the beauty of wood with the benefits of polymer. Our Rinato polymer acoustic boards are actually made from old recycled plastic bottles and household waste, provide a long lasting, low maintenance, great looking solution that is perfect for use in fences and privacy gates. They are UV resistant and their solid construction, with no wood content, means they don't absorb water and deflect unwanted noise outside the perimeter of your property. These boards are often used alongside busy roads and railway tracks.

This fencing system is not only cost effective, but also quick and easy to install and comes with a stylish enhanced wood grain to give a realistic wood effect that will last a lifetime. Available in three standard colours, these boards utilise our lightweight, strong and versatile steel post system which allows for the tongue and groove boards to slide down between the posts and secured with a simple extrusion which is screwed into place. This allows for the quick, economic installation for metres of fencing.

Working in partnership with
neular

We have now expanded our range to included more colours and options.

Wrapped Range – These premium range polymer boards are wrapped in a decorative wood effect laminate and are available in 3 colours. The range provides a stunning high quality solution for fences where aesthetics are essential.

Embossed Range – This new range of boards is available in 4 colours and is a more cost effective solution than the Wrapped Range, it has a realistic heat embossed woodgrain finish and is ideal for long runs of fencing that aren't in a prominent location or where aesthetics are less important.

Both of these ranges can work with our two different post system solutions. The first is our channel system, which allows you to screw our H and U channels to most types of posts and walls. The black gloss aluminium sections provide a discreet framing solution for the boards.



Scan here for the acoustic test results.





Rinato™ Polymer Fencing

The look of wood without the hassle

Wrapped

Premium decorative wood effect laminate wrap.



Golden Oak

Anthracite

Rustic Oak



L x H x T mm	Code
1800 x 138 x 28	66F00118
3600 x 138 x 28	66F00136

L x H x T mm	Code
1800 x 138 x 28	66F00318
3600 x 138 x 28	66F00336

L x W x T mm	Code
1800 x 138 x 28	66F00218
3600 x 138 x 28	66F00236

Embossed

Heat embossed woodgrain effect.



Black

Grey

Brown

Green



L x H x T mm	Code
1800 x 138 x 28	66F00618
3600 x 138 x 28	66F00636

L x H x T mm	Code
1800 x 138 x 28	66F00518
3600 x 138 x 28	66F00536

L x H x T mm	Code
1800 x 138 x 28	66F00718
3600 x 138 x 28	66F00736

L x H x T mm	Code
1800 x 138 x 28	66F00818
3600 x 138 x 28	66F00836

Board Profile Linear Expansion

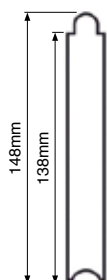

Please note: when designing gates and fencing using polymer boards, it is important to allow for a slight expansion of the boards at each end. When temperature rises 1°C boards expand 0.069mm per metre.

Installation Temperature (°C)	0	10	20	30	40	50
Space To Leave per 1m (mm)	5.0	4.0	3.0	2.0	1.5	1.0

When fixing the fence boards oversized holes should be pre-drilled for fixings. This will allow for expansion and contraction.



Scan here for the installation guide.

Steel

Wrought Iron Components

Gate Hardware

Sliding Door Gear

Gate Automation

Mesh

Decking & Subframe

Flooring & Stair Treads

Handrailing

Fencing

Fixings

Rinato™ Polymer Fencing



The look of wood without the hassle

Post & Channel System:

- Black gloss lightweight aluminium posts
- Available in bolt-down and concrete-in
- Easy to install extrusions that hold boards in place
- See online for our installation manual

How To Fix A 'U' Channel

Fixed On End Post

Fixed On Top

Fixed On Corner Post

Fixed On Corner Post Mitred Corners

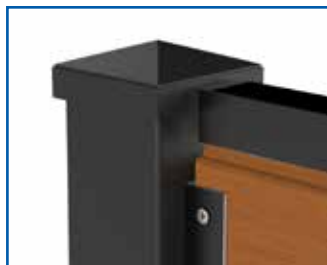

You can order online 24 hours a day, 7 days a week.
Visit our website: www.fhbrundle.co.uk



Secure from one end only to allow for expansion.

Concrete-In Post



Bolt-Down Post



U Channel

For top rail, corner & end posts

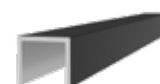

Fence Height m	Post size H x W x D mm	Code
1.2	1750 x 50.8 x 50.8	76PC5012B
1.3 - 1.5	1870 x 76.2 x 76.2	76PC7515B
1.8	2440 x 76.2 x 76.2	76PC7518B

Black gloss. 3mm thickness. Supplied with post cap.

Post Height mm	□ mm	Code
1155	50.8	76PB5012B*
1832	76.2	76PB7518B

Black gloss. 3mm thickness. Supplied with post cap. *Supplied with base plate cover cap.

Size mm	Length m	Code
30 x 34.5 x 30	5.8	66U60B

PPC black.

Screws



Size mm	Quantity	Code
4.2 x 12	1	76SS4212

Size mm	Quantity	Code
4.2 x 12	100	76SS4212D
4.2 x 12	100	76SS4212DB*

BZP. *Dacromet black finish.

Size mm	Quantity	Code
4.2 x 50	100	76SS4250D
4.2 x 50	100	76SS4250DB*

For fixing flat bar, boards or slats to front face of fence. BZP. *Dacromet black finish.

Create a stunning finish with Rinato™ deck boards



Steel

Wrought Iron Components

Gate Hardware

Sliding Door Gear

Gate Automation

Mesh

Decking & Subframe

Flooring & Stair Treads

Handrailing

Fencing

Fixings

Made To Order Gates

Choose from WPC, polymer or aluminium infills



- Steel
- Wrought Iron Components
- Gate Hardware
- Sliding Door Gear
- Gate Automation
- Mesh
- Decking & Subframe
- Flooring & Stair Treads
- Handrailing
- Fencing
- Fixings



We are pleased to offer steel framed gates with steel posts that can incorporate a wide choice of infill boards from our WPC, Polymer and Aluminium ranges. These gates can be tailored to your exact requirements and seamlessly integrated with one of our many fencing systems, offering a total perimeter solution.

Which Type Of Board Would You Like Your Gate Made From?

Rinato Polymer (see page 596)

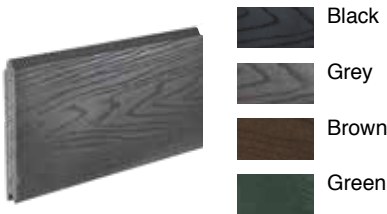

Rinato WPC (see page 594)

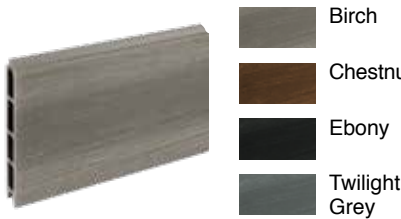

Marano Connect (see page 613)



Marano Parallel 50 (see page 612)



Marano Parallel 100 (see page 612)

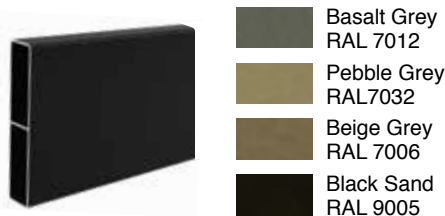

What sort of gates do you require?

- Pedestrian or Driveway
- Swing
- Bolt-down or Concrete-in posts
- Gate Locks & Gate Closers
- Gate Automation & Intercoms

We use quality brands from the gate hardware & automation market to build our gates



Images Show Examples Of Manual Gates





Made To Order Gates

Choose from WPC, polymer or aluminium infills

Our gates are made using quality gate hardware with steel posts and steel frames, that are galvanised and powder coated afterwards to a RAL colour of your choice. Guaranteeing a long-lasting solution.

Our Gates Can Be Supplied With:

Pyramid Post Caps



Slam Plate



Optional Cloaking Strip



Rear Hung 180° Gates

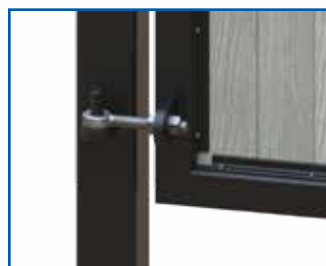

Single Leaf Gates

Maximum width 3m

Driveway Gates

Maximum width 6m



Single Leaf Gates Plan View



Driveway Gates Plan View



With The Option Of:

Slimline Locks

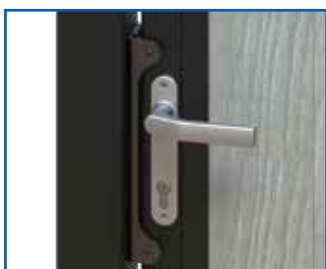

Drop Bars



Gate Closers

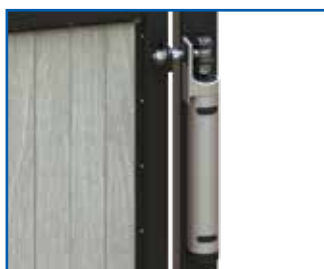

Automation

To be fitted on installation of gate



For more information call or visit your local branch today!

Scan here to download an order form.



Steel

Wrought Iron Components

Gate Hardware

Sliding Door Gear

Gate Automation

Mesh

Decking & Subframe

Flooring & Stair Treads

Handrailing

Fencing

Fixings

Marano® Boards

6 stylish designs



- Steel
- Wrought Iron Components
- Gate Hardware
- Sliding Door Gear
- Gate Automation
- Mesh
- Decking & Subframe
- Flooring & Stair Treads
- Handrailing
- Fencing
- Fixings



MARANO®
LIGHT • STYLE • VISION



We now have a total of 6 contemporary styles of aluminium fence/railings. Adding even more style to what is already one of the most extensive ranges of stocked metal fences available in the UK. Our aluminium fencing offers long lasting, low maintenance, easy to work with solutions that are also lightweight. Available in a range of finishes and colours, Marano® is easy to install and produces stunning results that will last for years to come. They can also be easily incorporated into steel gate frames and fixed to steel posts. In fact, with the easy to fix angle system, they can be fixed to almost any post you want, creating that privacy that is requested by so many clients these days.

Convex



Stripe



Elements



Connect



Parallel



Breeze





- Contemporary convex slats
- Available in 6m lengths

- Fits to the external face of the posts
- Choice of 2 colours

Golden Oak



L x H x T mm	Code
6000 x 100 x 15	76S001GO

Basalt Grey

RAL 7012



L x H x T mm	Code
6000 x 100 x 15	76S001A

End Cap



Colour	Code
Black	76S001CB

Plastic.

Connector



Colour	Code
Black	76S001IB

Plastic.



Scan here for the installation guide.

How To...

Attach To Post

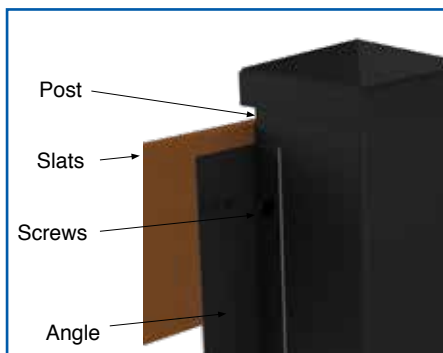

Screw angle onto both sides of post and screw through angle into slats to secure in place, then place end cap into each slat end.

Tackle Corners

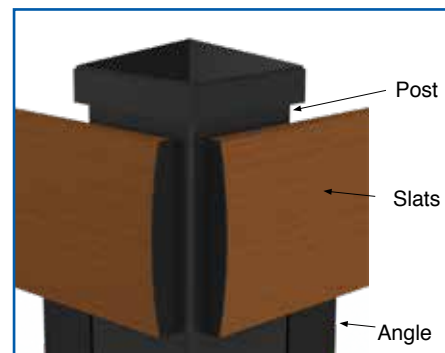

Screw angle onto post and screw through angle into slats to secure in place, then place end cap into slat end. Repeat for other side.

End A Run

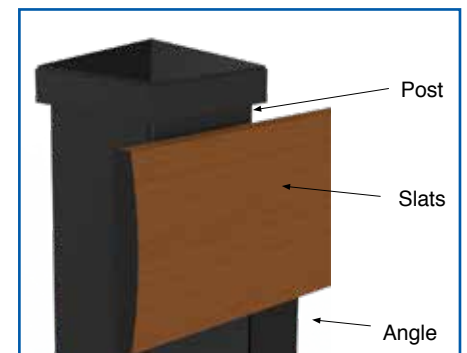

Screw angle onto post and screw through angle into slats to secure in place, then place end cap into slat end.

Marano® Stripe



Aluminium fence boards

- Double-sided boards
- Available in 6m lengths

- Quick & easy to build privacy fences
- Create different effects

Golden Oak



Smooth side.

L x H x T mm	Code
6000 x 100* x 15	76S002GO

*Overall height 108mm; to the shoulder 100mm.

Basalt Grey RAL 7012



Smooth side.

L x H x T mm	Code
6000 x 100* x 15	76S002A

*Overall height 108mm; to the shoulder 100mm.

Mill Finish

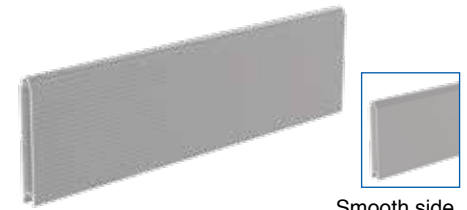

Smooth side.

L x H x T mm	Code
6000 x 100* x 15	76S002

*Overall height 108mm; to the shoulder 100mm.

Top Cap



Colour	Length mm	Code
Golden Oak	6000	76S002TCGO

Top Cap

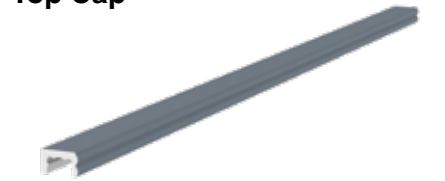

Colour	Length mm	Code
Basalt Grey RAL 7012	6000	76S002TCA

Top Cap



Colour	Length mm	Code
Mill Finish	6000	76S002TC

For posts & accessories see page 607.

Scan here for the installation guide.



Marano® Elements

Aluminium fence boards

- Our most versatile board system
- Double-sided boards

- Alternate boards with acrylic or anodised aluminium strips
- Create unique styles

Golden Oak



Smooth side.

L x H x T mm	Code
6000 x 100 x 15	76S003GO

Basalt Grey RAL 7012



Smooth side.

L x H x T mm	Code
6000 x 100 x 15	76S003A

Top Cap



Colour	Code
Golden Oak	76S003TCGO
Basalt Grey RAL 7012	76S003TCA

Length 6m.

Acrylic



Type	Code
Frosted	76S003FA
Clear	76S003CA

Size: 2030 x 100 x 10mm. No rubber gasket required.

Acrylic/Glass Gasket Per Metre

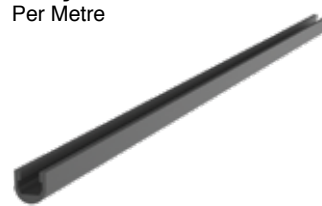

To Suit Glass mm	Code
6	76RG001

Length 1m. Rubber.

Insert



Length mm	Code
6000	76S003IA

Scan here for the installation guide.



Order our silicon for fixing top caps see page 607.

- Create a perfect privacy fence
- Available in 6m lengths

- Fits to the external face of the posts
- Choice of 4 colours or a mill finish

Pebble Grey

RAL 7032



L x H x T mm	Code
6000 x 144.5* x 16	76S006LS

*Overall height 150mm; to the shoulder 144.5mm.

Basalt Grey

RAL 7012



L x H x T mm	Code
6000 x 144.5* x 16	76S006A

*Overall height 150mm; to the shoulder 144.5mm.

Oak Wood Effect



L x H x T mm	Code
6000 x 144.5* x 16	76S006O

*Overall height 150mm; to the shoulder 144.5mm.

Serengeti Sand

RAL 1019



L x H x T mm	Code
6000 x 144.5* x 16	76S006SS

*Overall height 150mm; to the shoulder 144.5mm.

Mill Finish



L x H x T mm	Code
6000 x 144.5* x 16	76S006R

*Overall height 150mm; to the shoulder 144.5mm.

Top Cap

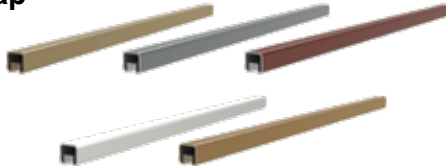

Colour	Code
Pebble Grey RAL 7032	76S006TCLS
Basalt Grey RAL 7012	76S006TCA
Oak Wood Effect	76S006TCO
Serengeti Sand RAL 1019	76S006TCSS
Mill Finish	76S006TCR

End A Run



To finish a run, use an aluminium angle from page 607 on the edge of the fencing board and fix using a clear silicone sealant code: **18990125366**

Marano® Parallel

- Discreet end cap & connectors
- Available in 6m lengths

- Fits to the external face of the posts
- Choice of 4 colours or a mill finish

Pebble Grey

RAL 7032



L x H x T mm	Code
6000 x 150 x 16	76S005LS

Basalt Grey

RAL 7012



L x H x T mm	Code
6000 x 150 x 16	76S005A

Oak Wood Effect



L x H x T mm	Code
6000 x 150 x 16	76S005O

Serengeti Sand

RAL 1019



L x H x T mm	Code
6000 x 150 x 16	76S005SS

Mill Finish

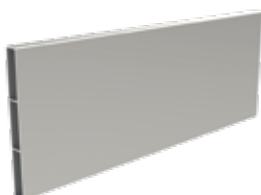

L x H x T mm	Code
6000 x 150 x 16	76S005R

End Cap & Connector



Description	Code
End Cap	76S005CB
Connector	76S005IB

Plastic.

Scan here for the installation guide.





- Easy to install slatted kits
- Suits our 1.2 & 1.8m posts

- Available in oak wood effect
- Fits between posts with discreet fixings

Kits Oak Wood Effect

Completed Fence Panel

For 1.2 or 1.8m post

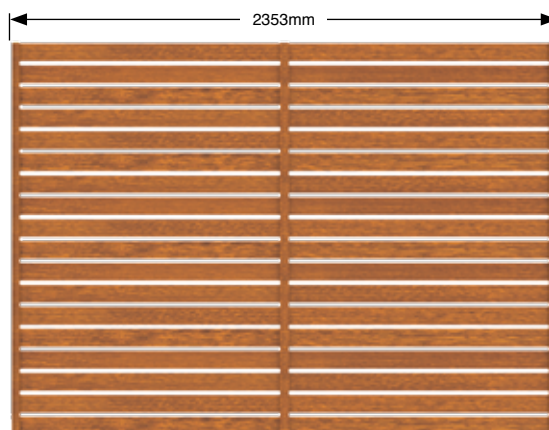

To Suit Fence Height m	Slat Size mm	Code
1.2	80 x 15	76S004O12
1.8	80 x 15	76S004O18

Kit includes: Slats to suit either a 1.2 or 1.8m fence height, 2 x F side channels, 1 x bracing channel, 3 x long covers to suit channels and plastic caps, covers / spacers to suit either kit, and fixings.

Installation



1 Slot slats and short covers alternately into the side channel to evenly space slats.



2 Screw through side channel into slats to secure firmly. Slide long cover down and snap into place.

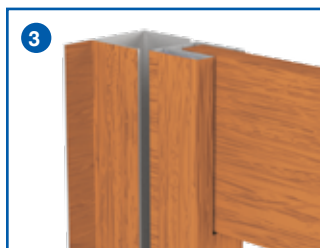

3 Slide completed fence panel into the F channel.



4 Secure completed fence panel into the F channel using screws supplied.



5 Secure to post by screwing through the F channel directly into post.



6 Place bracing channel centrally between the F channels and screw into panels. Slide long cover down and snap into place.



7 Push on cover caps to the side channels and the bracing channel.

For posts & accessories see page 607.

Concrete-In Post



Fence Height m	Post size H x W x D mm	Code
1.2	1750 x 50.8 x 50.8	76PC5012B
1.3 - 1.5	1870 x 76.2 x 76.2	76PC7515B
1.8	2440 x 76.2 x 76.2	76PC7518B

Black gloss. 3mm thickness. Supplied with post cap.

Bolt-Down Post



Fence Height m	Post size H x W x D mm	Code
1.2	1155 x 50.8 x 50.8	76PB5012B
1.8	1832 x 76.2 x 76.2	76PB7518B

Black gloss. 3mm thickness. Supplied with post cap and base plate cover cap.

Flat Bar



Size mm	Length m	Code
50 x 5	1.8	66FB50518

Black gloss.

Angle



Colour	Length m	Code
Black Gloss	1.1	76A001B12
Black Gloss	1.8	76A001B18
Golden Oak	1.8	76A001GO18
Basalt Grey RAL 7012	1.8	76A001A18

Bar size: 40 x 20 x 1.5mm.

Screws



Size mm	Quantity	Code
4.2 x 12	1	76SS4212

For fixing boards to angle.



Size mm	Quantity	Code
4.2 x 12	100	76SS4212D
4.2 x 12	100	76SS4212DB*

For fixing boards to angle. BZP. *Dacromet black finish.



Size mm	Quantity	Code
4.2 x 50	100	76SS4250D
4.2 x 50	100	76SS4250DB*

For fixing flat bar, boards or slats to front face of fence. BZP. *Dacromet black finish.

Silicone



Colour	ml	Code
Clear	310	189901201

Silicone Gun



Code
189900666

Remember to order your silicone for fixing top caps

Complement your fencing with our range of aluminium deck boards. For more information see from page 374.

Marano systems are very versatile and can be used in a range of applications. Below are a few installation ideas and solutions.

Bolt-Down & Stepped System Using End Caps

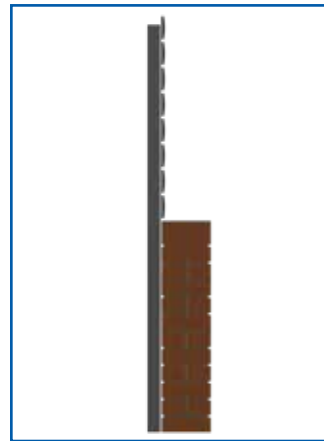
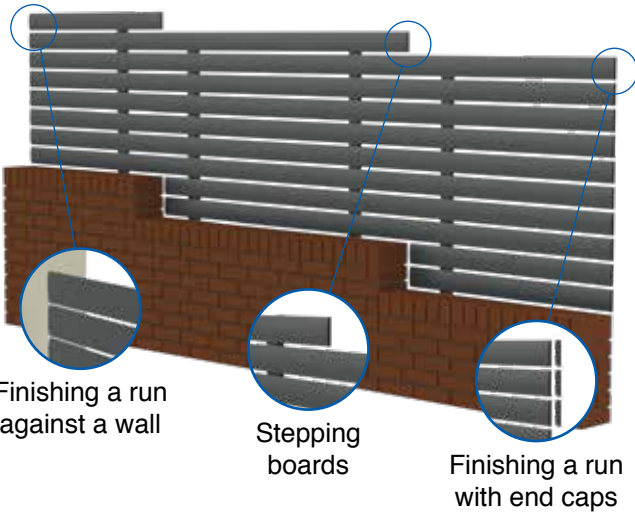

Side fixed posts

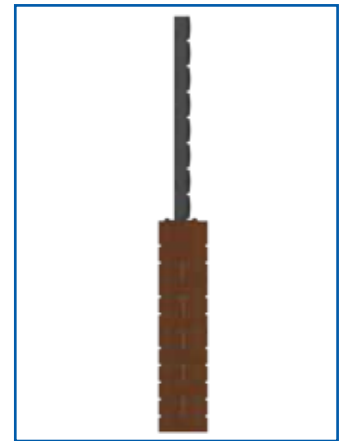

Bolt-down posts

Concrete-In Sloped System Using Aluminium Angle

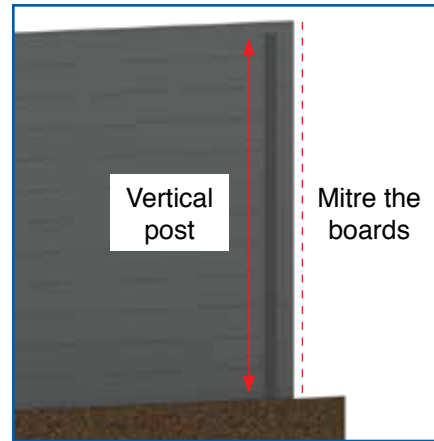
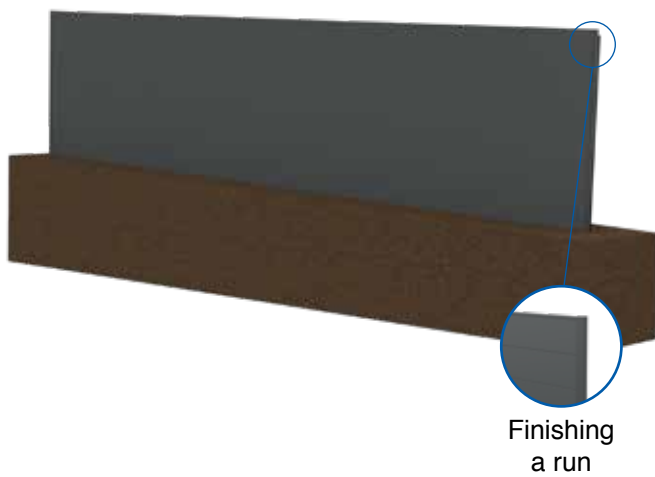

Raked boards

Wall Fixing Using Aluminium Angle



Open fencing systems



Closed fencing systems

For our full range of Marano fencing see from page 602.

As part of our Synergised decking system we offer two high quality, cost effective and non-combustible decking solutions that will help transform your outdoor space.

Both systems are easy to install and are suitable for domestic and commercial environments. Installation could not be easier, with our high-quality porcelain tiles installed directly onto a flat concrete floor. Our aluminium deck boards can be mounted onto our mill finished adjustable cradles and joists. Or combined with our unique innovative perimeter base system, which allows for a wide range of base fix handrailing solutions to be bolted to the perimeter, providing a safe edge protection where there is a fall of more than 600mm.

Porcelain Tiles



- Italian porcelain from one of Italy's top design houses
- Stunningly realistic natural wood effect
- Low maintenance & easy to install
- Low surface temperature & UV resistant
- Anti-slip
- Non-combustible
- Two collections with a choice of 5 colours in each
- 100% recyclable
- Ideal for elevated patios, all decking applications, and all types of balconies



Aluminium Deck Boards

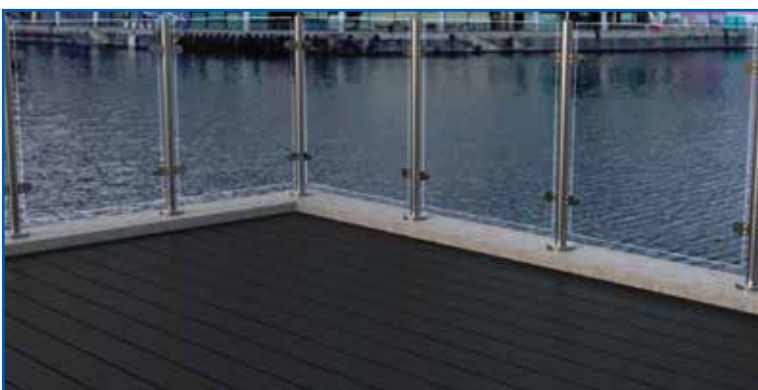

- Achieves Euroclass Classifications of A1 & A2fl-s1
- Made from structural grade 6063 T6 aluminium
- Ideal for high rise concrete balconies & terraces
- Up to 50% cost saving compared to other systems
- 100 micron Qualicoat™ premium powder coating
- Low surface temperatures
- Long lasting and low maintenance
- Lightweight and easy to install

Request a FREE sample today!

For more details see from page 374.

- Steel
- Wrought Iron Components
- Gate Hardware
- Sliding Door Gear
- Gate Automation
- Mesh
- Decking & Subframe
- Flooring & Stair Treads
- Handrailing
- Fencing
- Fixings



Request a free sample.



As awareness has grown of the advantages to using aluminium in the construction of gates and railings, so has our range of extrusions. Marano Integrated offers long lasting, lightweight aluminium boards with total flexibility.

This fencing solution can provide either complete privacy or open boards mixed in with contemporary laser cut screens to add some decorative design to the garden. All the boards and full height screens can be used in conjunction with each other.



Steel fabricators and gate makers can easily incorporate these boards into steel gate frames and rely on the extensive F.H. Brundle range of steel sections, gate hardware and automation to create matching gates specific to customers' requirements.

This fencing system is available in four powder coated matt finish boards or alternatively a mill finish, to allow you to powder coat to your preferred choice of RAL colour. Marano Intergrated is aluminium, so it is lightweight and easy to work with. For fences lower than 1.8m, or for bolt down post requirements, posts can be cut to size on site. Additional post accessories can be bought individually on page 613.



One universal post can be used as a mid, end and corner post, just simply buy the additional extrusions you require. The four different styles of board can be used to create these different designs below. The boards are discretely integrated into the posts to hide all fixings and fastenings, with a cover cap that slides easily into place after fixing.



It is difficult to envisage on paper the finish of the different colour options and quality of the powder coating, which is why we offer a sample service. If you would like to see any of the boards and the colour options, please order them online. The cost of the samples will be refunded upon your first order.

Basalt Grey
RAL 7012



Pebble Grey
RAL 7032



Beige Grey
RAL 7006



Black Sand
RAL 9005



Mill Finish

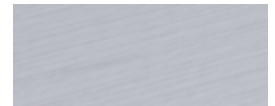

- Quick assembly with hidden fixings
- Mix & match the different boards to create unique designs

- Choice of 4 colours in a stylish matt finish
- Bolt-down or concrete-in post options
- 10 year warranty

Top cap with connect board

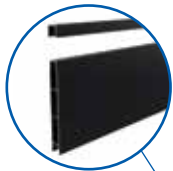

Mid post with laser cut screen insert

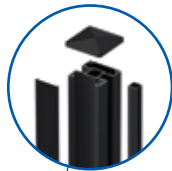

Mid post with corner post insert

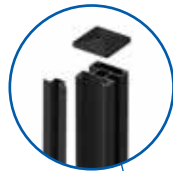

Support kit



Screen with fixing kit



If bolt down posts are required, cut post to length and attach base plate

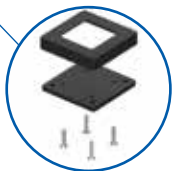

Fix your boards in the hidden channel before applying the capping to hide the screws

Parallel boards used with 25mm spacers

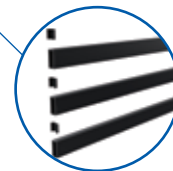

Parallel 50 Board

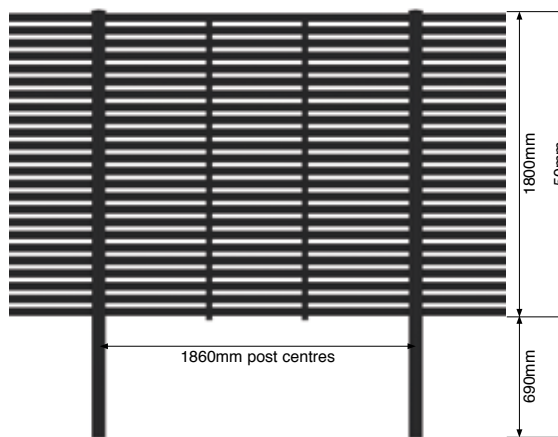

Board Size

L: 1825mm x H: 50mm x T: 20.6mm



Colour	Code
Basalt Grey	76S00750A

Colour	Code
Pebble Grey	76S00750LS

Colour	Code
Beige Grey	76S00750BG

Colour	Code
Black Sand	76S00750BS

Colour	Code
Mill Finish	76S00750R



For 25mm Spacers see below.

Parallel 100 Board

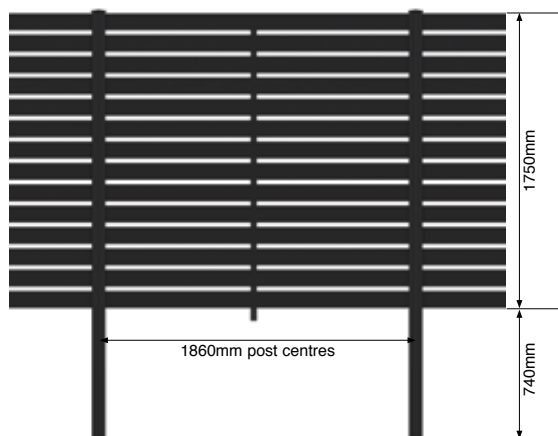

Board Size

L: 1825mm x H: 100mm x T: 20.6mm



Colour	Code
Basalt Grey	76S007100A

Colour	Code
Pebble Grey	76S007100LS

Colour	Code
Beige Grey	76S007100BG

Colour	Code
Black Sand	76S007100BS

Colour	Code
Mill Finish	76S007100R



For Base Plates see page 616.

Half Round Board

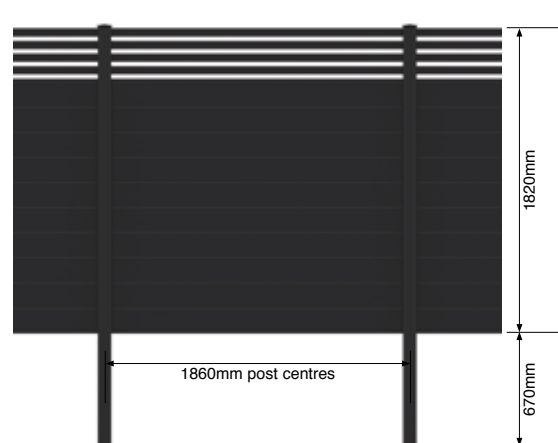

Board Size

L: 1825mm x H: 55mm x T: 20.6mm



Colour	Code
Basalt Grey	76S009A

Colour	Code
Pebble Grey	76S009LS

Colour	Code
Beige Grey	76S009BG

Colour	Code
Black Sand	76S009BS

Colour	Code
Mill Finish	76S009R

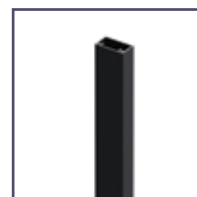

For Wall Support Kit see page 616.

Spacer Kits 25mm



Colour	Qty	Code
Basalt Grey	50	76S007C25A
Black Sand	50	76S007C25BS

Fixings For Boards



Size mm	Qty	Code
4.2 x 12	100	76SS4212DB

Dacromet black finish.

Support Kit 1.8m



Colour	Code
Basalt Grey	76S007SA
Black Sand	76S007SBS

For fixings, see code: 76SS4212DB.

Connect Board

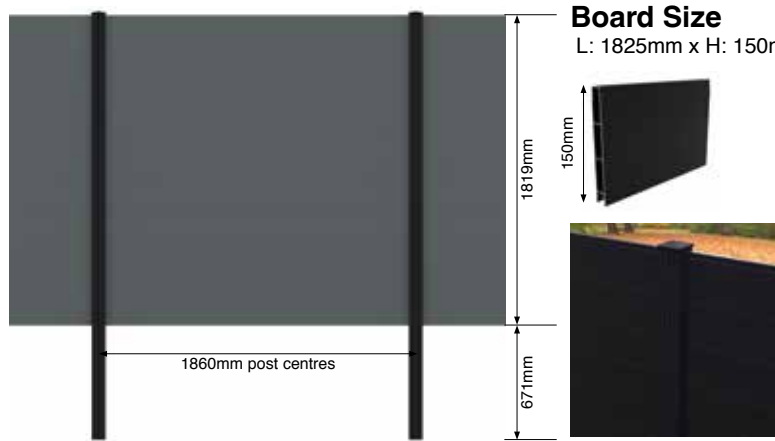

Board Size

L: 1825mm x H: 150mm x T: 20mm

	Colour	Code
	Basalt Grey	76S008A
	Colour	Code
	Pebble Grey	76S008LS
	Colour	Code
	Beige Grey	76S008BG
	Colour	Code
	Black Sand	76S008BS
	Colour	Code
	Mill Finish	76S008R



Connect Board with Top Cap

Top Cap 1825mm

Basalt Grey

Pebble Grey

Beige Grey

Black Sand

Mill Finish



Code
76S008TCA

Code
76S008TCLS

Code
76S008TCBG

Code
76S008TCBS

Code
76S008TCR

Mid Post Concrete-In 1.8m

Supplied with post cap

End / Corner Post Insert 2.5m

Corner Post Insert 2.5m



Colour	Size mm	Code
Basalt Grey	80 x 80	76PCM18A
Black Sand	80 x 80	76PCM18BS

Colour	Code
Basalt Grey	76E24A
Black Sand	76E24BS

Colour	Code
Basalt Grey	76C24A
Black Sand	76C24BS

Side capping will need to be cut to size after posts are concreted-in.

How To Create Corner & End Posts

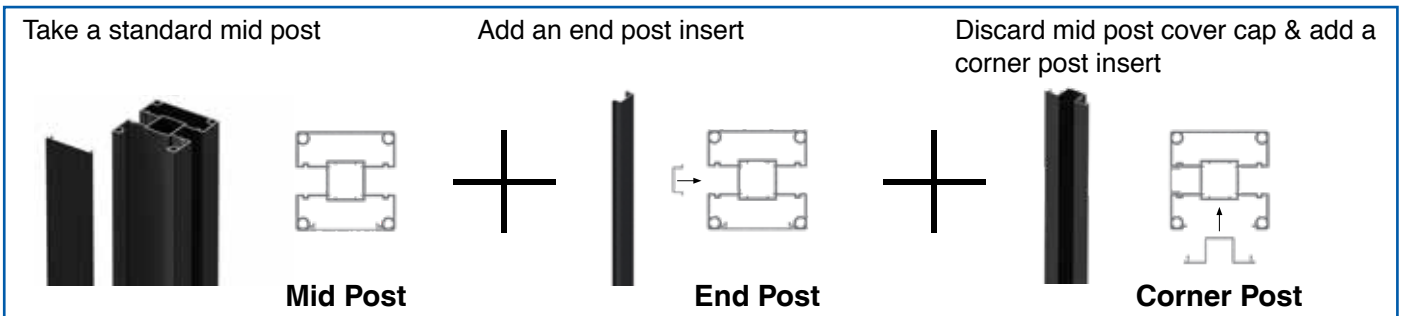

How To Use Laser Cut Screen Inserts

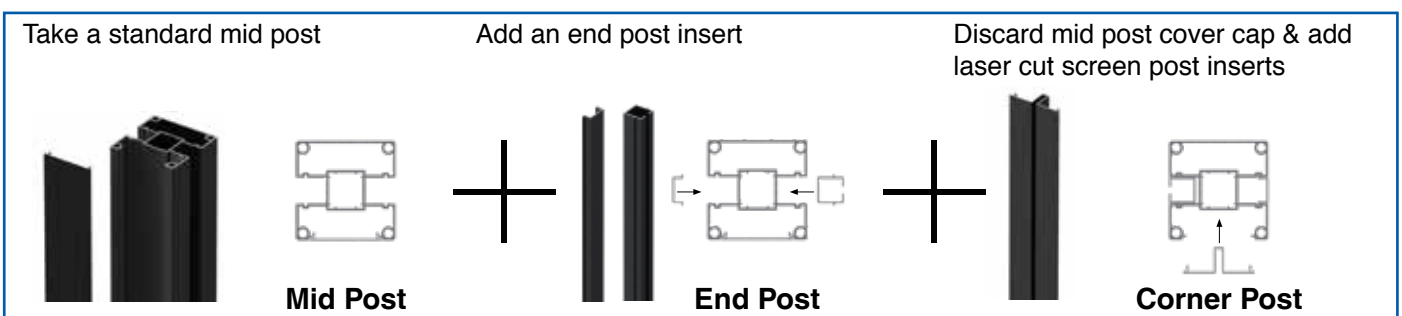

Designs have been created using bolt-down posts, Marano Connect boards, full screen installed vertically or horizontally and slim screen installed horizontally. All screens are attached using a screen fixing kit. Components are treated with a high quality UV resistant powder coated finish. Board samples are available on request.

Pattern 1

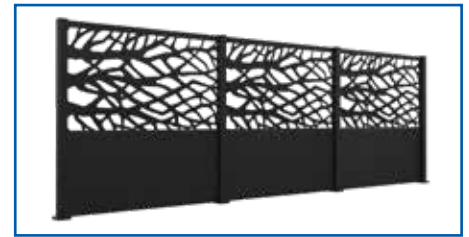
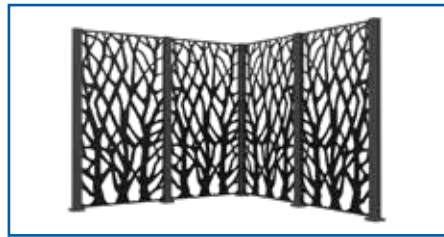

Pattern 2



Pattern 3

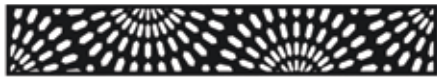

- Steel
- Wrought Iron Components
- Gate Hardware
- Sliding Door Gear
- Gate Automation
- Mesh
- Decking & Subframe
- Flooring & Stair Treads
- Handrailing
- Fencing
- Fixings

Connect Board With Screens

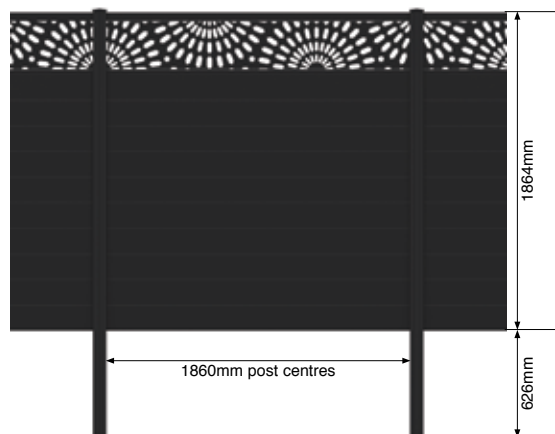

Screen Fixing Kit

L: 1825mm



Colour	Code
Basalt Grey	76S007LA
Black Sand	76S007LBS

Kit comes with bottom channel, top channel and 2 rubber gaskets.



For more designs, visit our website: www.fhbrundle.co.uk

Screen Size

W: 1825mm x H: 300mm x T: 5mm



Design	Colour	Code
Pattern 1	Black Sand	76S007LCP01



Design	Colour	Code
Pattern 2	Black Sand	76S007LCP02



Design	Colour	Code
Pattern 3	Black Sand	76S007LCP03

Screen Size

W: 1000mm x H: 1800mm x T: 5mm



Design	Colour	Code
Pattern 1	Black Sand	76S007LCP01F



Design	Colour	Code
Pattern 2	Black Sand	76S007LCP02F



Design	Colour	Code
Pattern 3	Black Sand	76S007LCP03F

Plan View Of Mid Posts With Laser Cut Screen Inserts



Laser Cut Screen Mid Post Insert 2.5m



Colour	Code
Basalt Grey	76S007LPA
Black Sand	76S007LPBS

Laser Cut Screen Corner Post Insert 2.5m

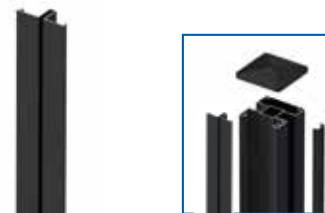

Colour	Code
Basalt Grey	76S007LCA
Black Sand	76S007LCBS

Please buy the mid posts plus the correct number of inserts to secure the laser cut screens.

- Steel
- Wrought Iron Components
- Gate Hardware
- Sliding Door Gear
- Gate Automation
- Mesh
- Decking & Subframe
- Flooring & Stair Treads
- Handrailing
- Fencing
- Fixings



Base Plate & Cover Cap

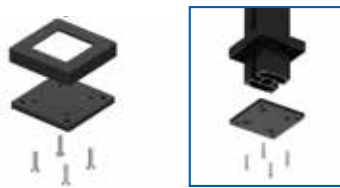

Colour	Code
Basalt Grey	76BPA
Black Sand	76BPBS

Comes with 4 screws for fixing.

Wall Support Kit 1.8m



Colour	Code
Basalt Grey	76S007SA
Black Sand	76S007SBS

For fixings, see code: **76SS4212DB**.

Fixings For Support Kit



Size mm	Qty	Code
4.2 x 12	100	76SS4212DB

Dacromet black finish.

Wall Fixing Post 1.8m



Colour	Code
Basalt Grey	76PWE18A
Black Sand	76PWE18BS

Supplied with post cap. Overall length 1.9m.

Wall fixing post can be cut down for use on brick pillars. Please buy additional post caps if required. Can also be used to secure boards into existing concrete posts.



Additional Parts

ABS 80 x 80mm Post Cap



Colour	Code
Basalt Grey	76PT01A
Black Sand	76PT01BS

Included with Post. Plastic.

Post Cap For Wall Post



Colour	Code
Basalt Grey	76PTW01A
Black Sand	76PTW01BS

Included with Wall Post.

Rubber Gasket For Laser Cut Screens



Per Metre	Code
1	76S007RS

Included with Screen Fixing Kit.



Years of technological expertise have gone into creating these special profiles, which can be used as a standalone product, or with an existing structure. Made in the UK, we only use the highest grade recycled plastic and the result is our strongest joists yet. Unlike wood or steel, the weather cannot harm them. They can span wider gaps and combines strength and durability with a quality finish.

Features

- Weather resistant
- Rot resistant
- Splinter free
- Moisture repellent - fast drying
- Produced without preservatives
- Sustainably environmentally friendly
- Reduces the strain on landfills
- Long lasting
- Resistant to oils, brines, acids & salt water
- Low maintenance
- Made of high-quality processed secondary plastics

Rounded Top Fencing Pales



Colour	Size H x W x T mm	Code
Black	1200 x 100 x 25	74022510012B
Brown	3000 x 100 x 25	7402251003BN

Square Posts & Rails



Colour	Size L x H x W mm	Code
Black	3600 x 50 x 50	7401505036B
Black	3600 x 95 x 95	7401959536B
Brown	3000 x 40 x 40	740140403BN
Brown	3600 x 50 x 50	7401505036BN
Brown	3600 x 95 x 95	7401959536BN

Horizontal Rails



Colour	Size L x H x W mm	Code
Black	3600 x 50 x 95	7401955036B
Brown	3600 x 50 x 95	7401955036BN
Black	3600 x 50 x 140	74011405036B
Brown	3600 x 50 x 140	74011405036BN

Fixings

SDW Structural Wood Screw

Pack of 50



Length mm	Ø mm	Code
86	M8	75SWS86
127	M8	75SWS127
152	M8	75SWS152

Heat treated carbon steel. Black E-coat™.

You can order online 24 hours a day, 7 days a week. Visit our website: www.fhbrundle.co.uk

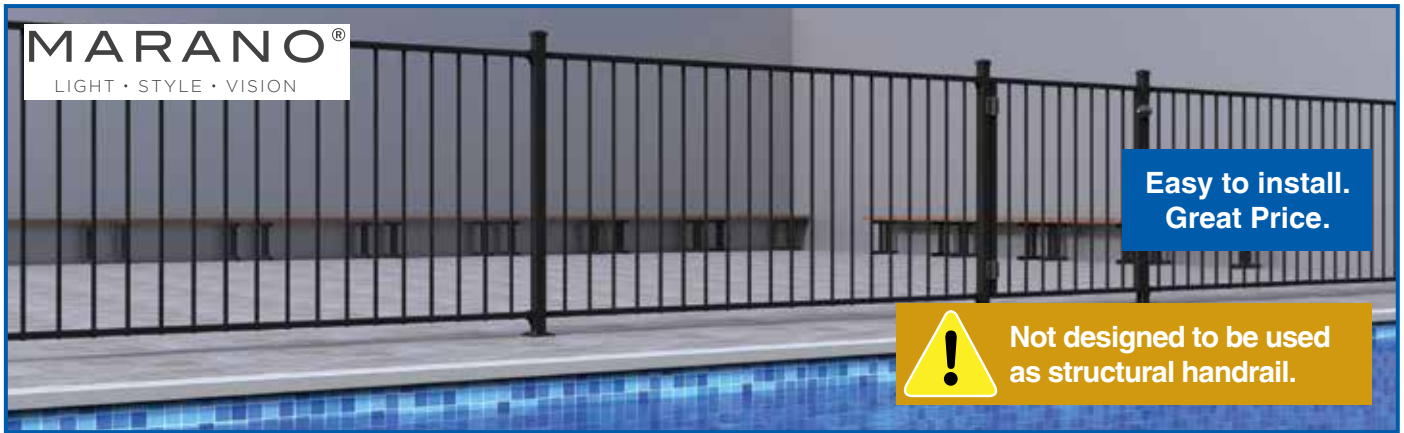

Easy to install.
Great Price.

! Not designed to be used as structural handrail.

Aluminium railings are quick and simple to install with no welding required. This system is polyester powder coated gloss black RAL 9005, which makes it ideal for indoor and outdoor use. Railings are not designed for use on balconies or where the fall is greater than 600mm.

Price Per Metre Run



Post	Overall Height m	Code
Bolt-down	1.0	59RP10BM
Concrete-in	1.2	59RP11CBM
Bolt-down	1.2	59RP11BM

Supplied with posts, caps, brackets and fixings. Please order an extra post to finish the run.

Railing Panel

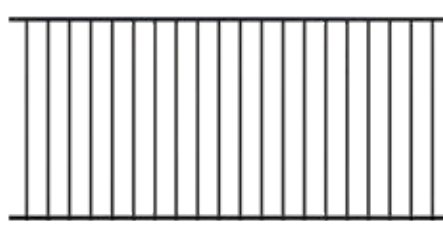

Overall Height m	Height mm	Width mm	Code
1.0	900	2400	59RP10B
1.2	1100	2400	59RP12B

25 x 38 x 2.5mm horizontal rails. Ø 16 x 1.2mm infill bars.

Gate

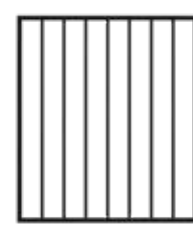

Overall Height m	Height mm	Width mm	Code
1.0	900	962	59SLG10B
1.2	1100	962	59SLG12B

38 x 25 x 1.5mm frame. Ø 16 x 1.2mm infill bars. Please order hinges and latches below.

Concrete-In Post



Overall Height m	Height mm	□ mm	Code
1.2	1600	50	59PC12B

2.5mm thickness.

Bolt-Down Post

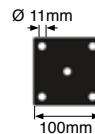

Overall Height m	Height mm	□ mm	Code
1.0	1050	50	59PB105B
1.2	1250	50	59PB125B

2.5mm thickness.

Railing Bracket

Pack of 4



Colour	To suit □ mm	Code
Black	25 x 38	59BR3825B

Supplied as a pack of 4, with 12 x self-drilling screws.

Post Cap



□ mm	Code
50	59PT50B

Hammer fit.

Accessories

Product	Code
Magnetic latch. Supplied with fixings. Polymer	Non-lockable: 09FA27 . Lockable: 09FA28 .
Hinge. Supplied in pairs. Please order 8 x 59SC519B . Polymer	09FA30
Lockable drop bar. Supplied with fixings	09FA29
Self-drilling screw. M5 x 19mm long. Dacromet coated	Black gloss: 59SC519B .



Features:

- Galvanised or polyester powder coated gloss black RAL 9005
- Fence height 1m
- Panels welded with Ø 20mm horizontal top tubes
- Slotted holes allow the fence panel height to be adjusted
- No welding required
- Bolt-down & spike feet options available
- Panels & end bars have three H 39 x W 9mm fixing slots
- Bolt-down & spike feet have two Ø 9.5mm fixing holes
- Reversible latch for left or right hung gates
- Bolt-on catch can be moved to suit required position

Price Per Metre Run



Description	Foot	Code
Galvanised	Bolt-down	65FPB09M
Black RAL 9005	Bolt-down	65FPB09BM
Galvanised	Spike	65FPS09M
Black RAL 9005	Spike	65FPS09BM

1.2m Width. Supplied with fixings.

Spike Foot End Post



Description	Bar Height m	Code
Galvanised	1	65EPS01
Black RAL 9005	1	65EPS01B

Supplied with fixings to bolt end post to panel.

Bolt-Down End Post

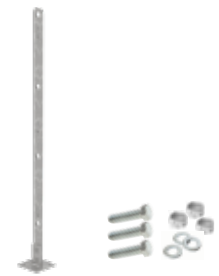

Description	Bar Height m	Code
Galvanised	1	65EPB01
Black RAL 9005	1	65EPB01B

Supplied with fixings to bolt end post to panel.

Pedestrian Gate

With concrete-in posts

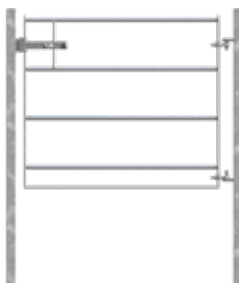

Gate Height m	Post □ mm	Width Between Posts m	Code
1	50	1.2	65SLG12
1	50	1.2	65SLG12B*

Supplied with latch. *PPC gloss black RAL 9005.

Drive Gate

With concrete-in posts

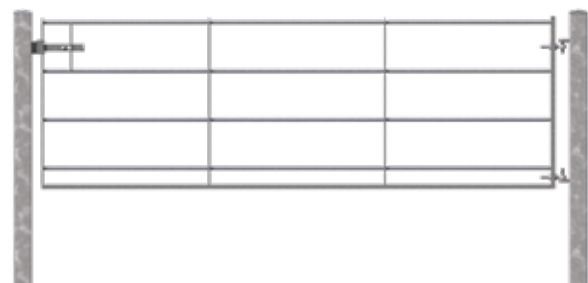

Gate Height m	Post □ mm	Width Between Posts m	Code
1	100	3	65DLG12
1	100	3	65DLG12B*

Supplied with latch. *PPC gloss black RAL 9005.

Our galvanised railings can be easily powder coated to your preferred choice of colour.



Fence Panel

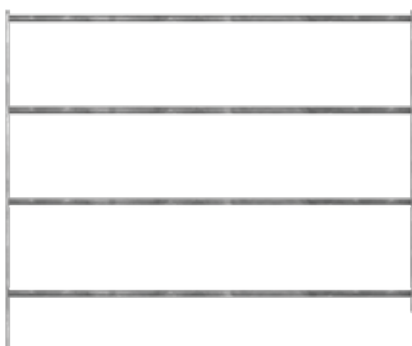

End Post



Width m	Code
1.2	65FP09
1.2	65FP09B*

Requires three M8 x 30mm bolts to join to next panel. *PPC gloss black RAL 9005.

Height m	Code
1	65EB01
1	65EB01B*

Requires three M8 x 30mm bolts to join to end panel. *PPC gloss black RAL 9005.

Spike Foot



Bolt-Down Foot

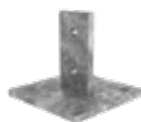

Hexagonal Bolt



Height mm	Code
410	65FT01S
410	65FT01SB*

Requires two M8 x 30mm bolts to join to end post. *PPC gloss black RAL 9005.

Height mm	Base Plate ■ mm	Code
86	100	65FT01B
86	100	65FT01BB*

Requires two M8 x 30mm bolts to join to end post. Base plate fixing holes Ø 11.5mm. *PPC gloss black RAL 9005.

Thread Ø mm	Length mm	Code
M8	30	5002HS08X30

Flat Plain Washer



To suit Ø mm	Code
M8	5002FW08

Hexagonal Full Nut



To suit Ø mm	Code
M8	5002HN08

Touch Up Paint

Black gloss



Description	Size ml	Code
Brushable	125	29PC125TB
Spray	400	29PC400SB

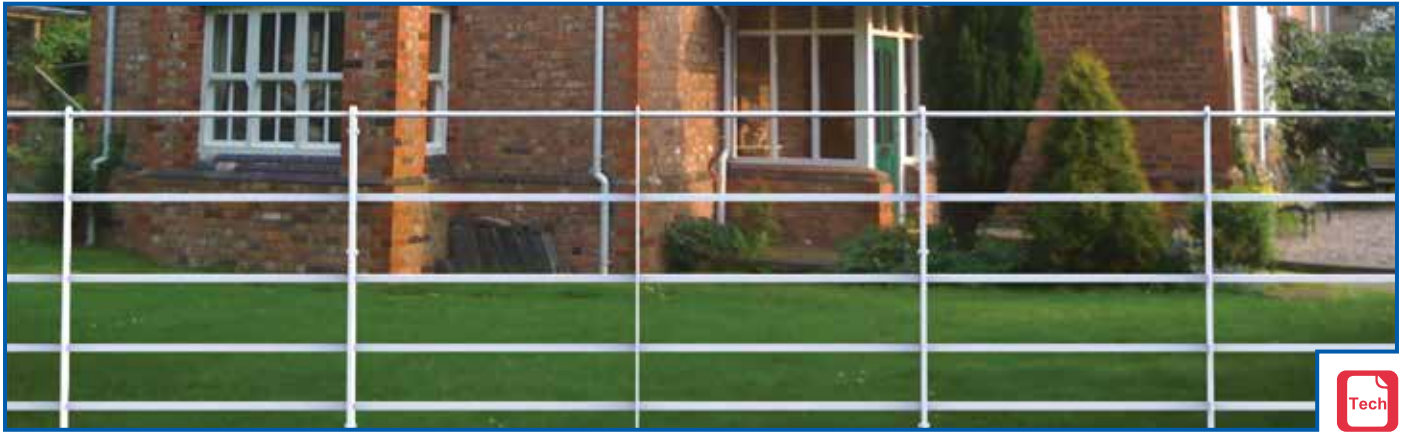

This type of fencing and gates have become a popular solution with house builders in residential developments. Our estate fencing is supplied in ready made panels, making it a quick and economical fencing solution. Also ideal for use as continuous boundary fence in parkland, paddocks and estates.

Features:

- Galvanised or polyester powder coated gloss black RAL 9005
- Height 1.2m
- Welded with Ø 20mm top tube & 25 x 6mm bars
- Slotted holes allow for fence panel height to be adjusted by 39.5mm
- Pre-drilled holes to fit straining wire to reduce the gap between rails in lower section of fence
- No welding required
- Gates are lockable with a padlock (not supplied)
- Gates can easily be reversed for either hand opening

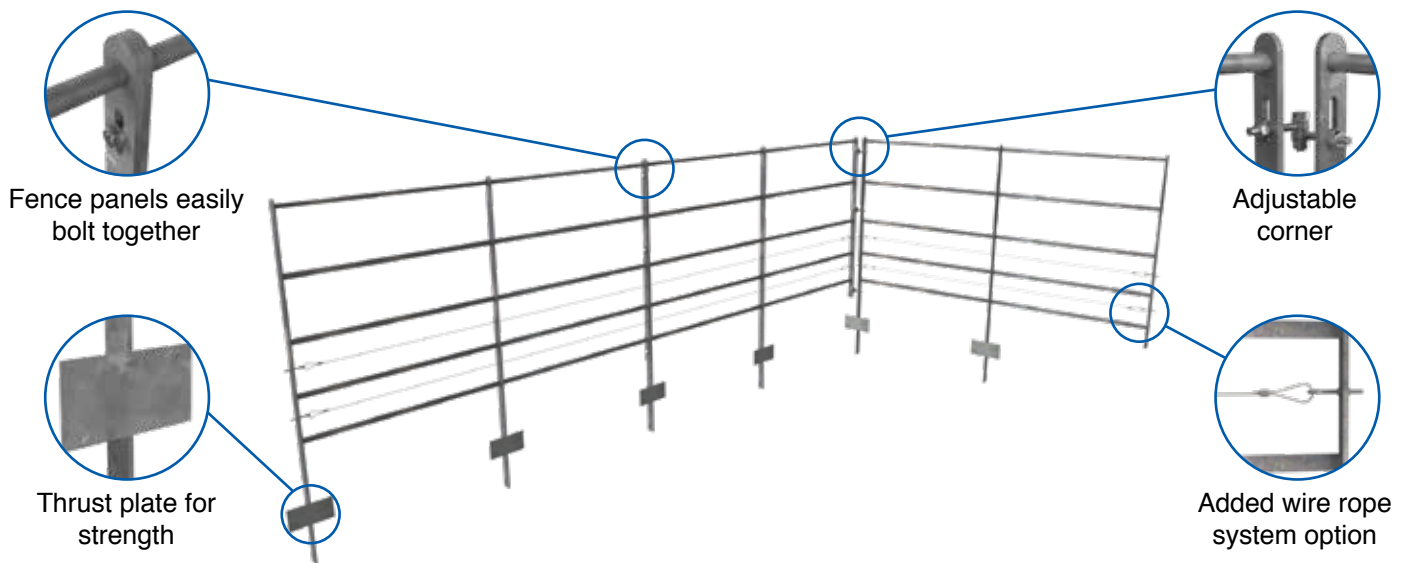

Post Corner Option

Pedestrian Or Drive Gate

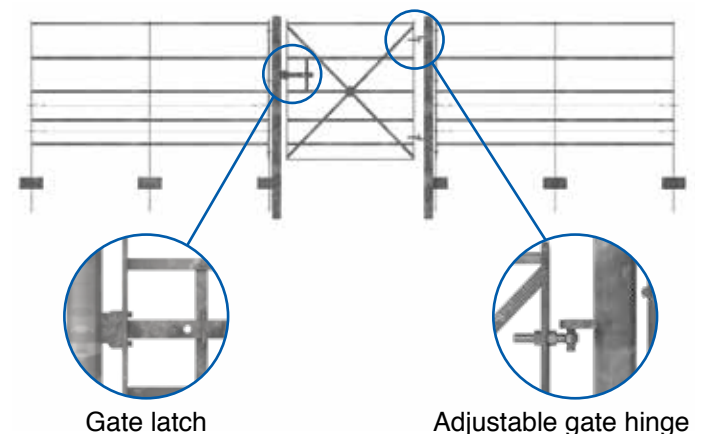
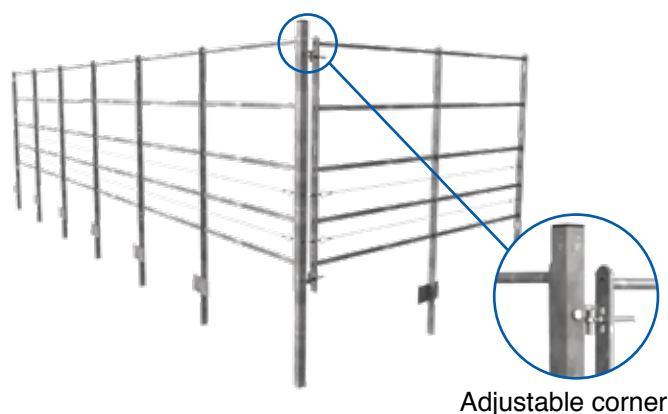

- Steel
- Wrought Iron Components
- Gate Hardware
- Sliding Door Gear
- Gate Automation
- Mesh
- Decking & Subframe
- Flooring & Stair Treads
- Handrailing
- Fencing
- Fixings

Price Per Metre Run

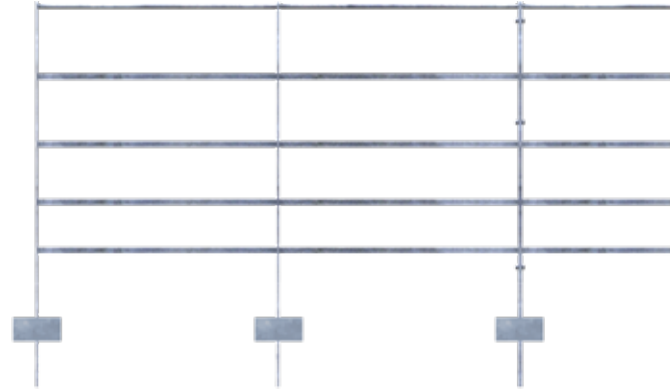

Height m	Width m	Horizontal Top Tube Ø mm	Horizontal Bars mm	Code
1.6	2.0	20	25 x 6	55FP12M
1.6	2.0	20	25 x 6	55FP12BM*

Supplied with fixings. *PPC gloss black RAL 9005. Please order an end fixing bar to finish the run.

End Fixing Bar

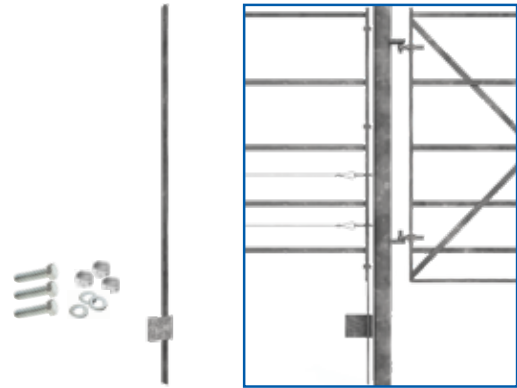

Height m	Code
1.6	55EF01
1.6	55EF01B*

Bar 40 x 8mm. Supplied with fixings. *PPC gloss black RAL 9005.

Pedestrian Gate

With concrete-in posts

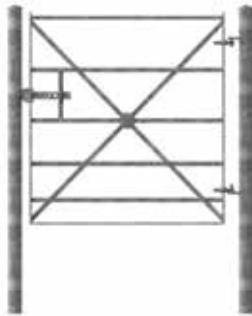

Gate Height m	Post Ø mm	Width Between Posts m	Code
1.15	76.1	1.2	55SLG12
1.15	76.1	1.2	55SLG12B*

Supplied with latch. Will fit an opening width from 1.19 - 1.23m between faces of the posts. *PPC gloss black RAL 9005.

Drive Gate

With concrete-in posts

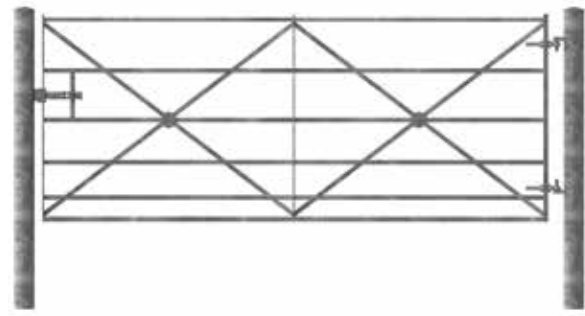

Gate Height m	Post Ø mm	Width Between Posts m	Code
1.15	114.3	3.0	55DLG12
1.15	114.3	3.0	55DLG12B*

Supplied with latch. Will fit an opening width from 2.97 - 3.07m between faces of the posts. *PPC gloss black RAL 9005.

Corner / End Post

Also suitable for angles



Height m	Code
1.6	55CP12
1.6	55CP12B*

Post 40 x 40mm. Supplied with eye bolts. Requires end fixing bar. *PPC gloss black RAL 9005.

Adjustable Corner

Set of 3



Code
55AC01

Fence Panel Stay

For extra rigidity



Code
55FS01
55FS01B*

Supplied with fixings. *PPC gloss black RAL 9005.



For extra security, wire rope can be added to the bottom of the estate fence. For ease of installation fixing bars come pre-drilled with two Ø 7mm holes for wire tensioners.

Wire Fittings

Eye Bolt & Nuts



Length mm	Thread Ø mm	Code
152	6	0702027

Wire



Ø mm	Length m	Code
2.50	640	040201264
3.15	400	040201315

Ferrule



Length mm	Code
15.8	1301609

Hydraulic Crimping Tool



Code
189900103

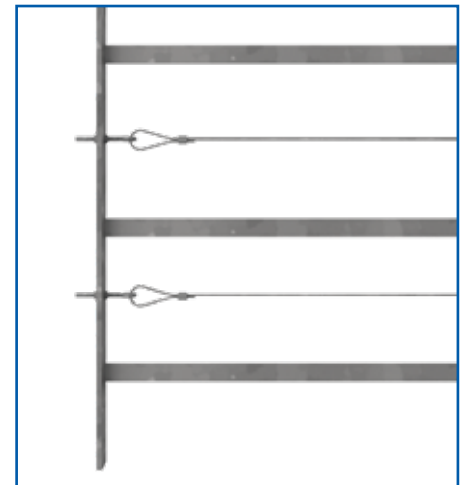

Fence Panel - Single

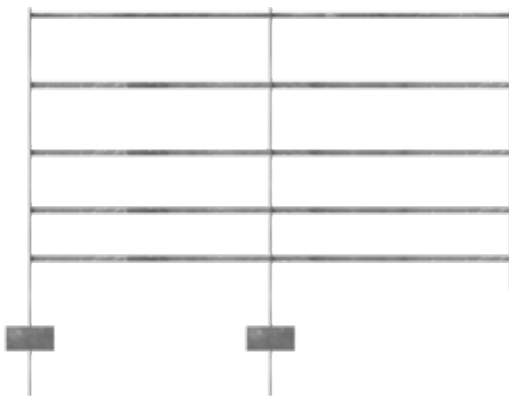

Height m	Width m	Horizontal Top Tube Ø mm	Horizontal Bars mm	Code
1.6	2.0	20	25 x 6	55FP12
1.6	2.0	20	25 x 6	55FP12B*

Touch Up Paint

Black gloss



Description	Size ml	Code
Brushable	125	29PC125TB
Spray	400	29PC400SB

Requires three M10 x 30mm hex bolts, washers and nuts. *PPC gloss black RAL 9005.

Our galvanised railings can be easily powder coated to your preferred choice of colour.



Our loose component estate fencing is supplied with ready-made posts and long length 6m bars, making it a quick and economical fencing solution. Ideal for use as continuous boundary fence in parkland, paddocks and country estates.

Features:

- Supplied self colour to naturally rust or paint after installation
- Gates can easily be reversed for either hand opening
- Gates are lockable with a padlock (Code: 51PLK50L)
- Fence height 1.2m
- Post spacing 1.0m maximum
- No welding required

Self Colour Posts - To give 1.2m fence height

Start / End

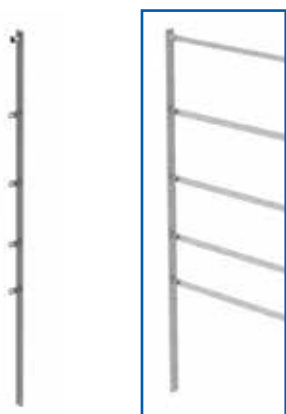

Length m	Code
1.5	65EP12
2.0*	65EP12L

*2.0m long length posts for soft ground

Through

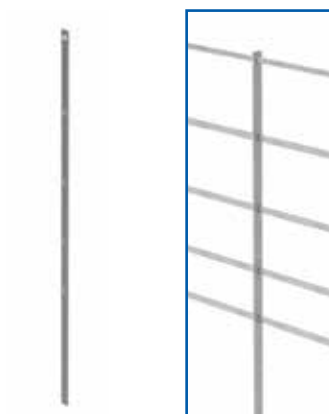

Length m	Code
1.5	65TP12
2.0*	65TP12L

*2.0m long length posts for soft ground

Connecting

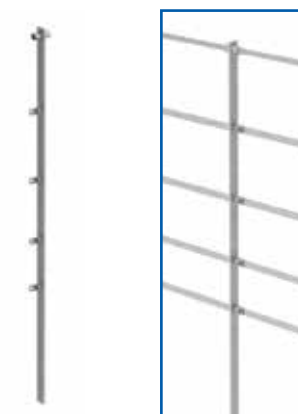

Length m	Code
1.5	65iP12
2.0*	65iP12L

*2.0m long length posts for soft ground

Corner

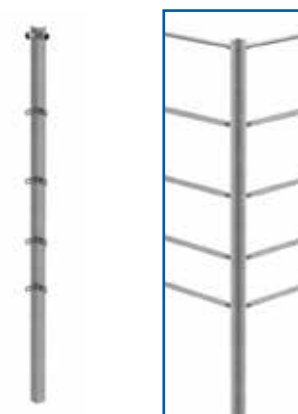

Length m	Code
1.5	65CP12
2.0*	65CP12L

*2.0m long length posts for soft ground

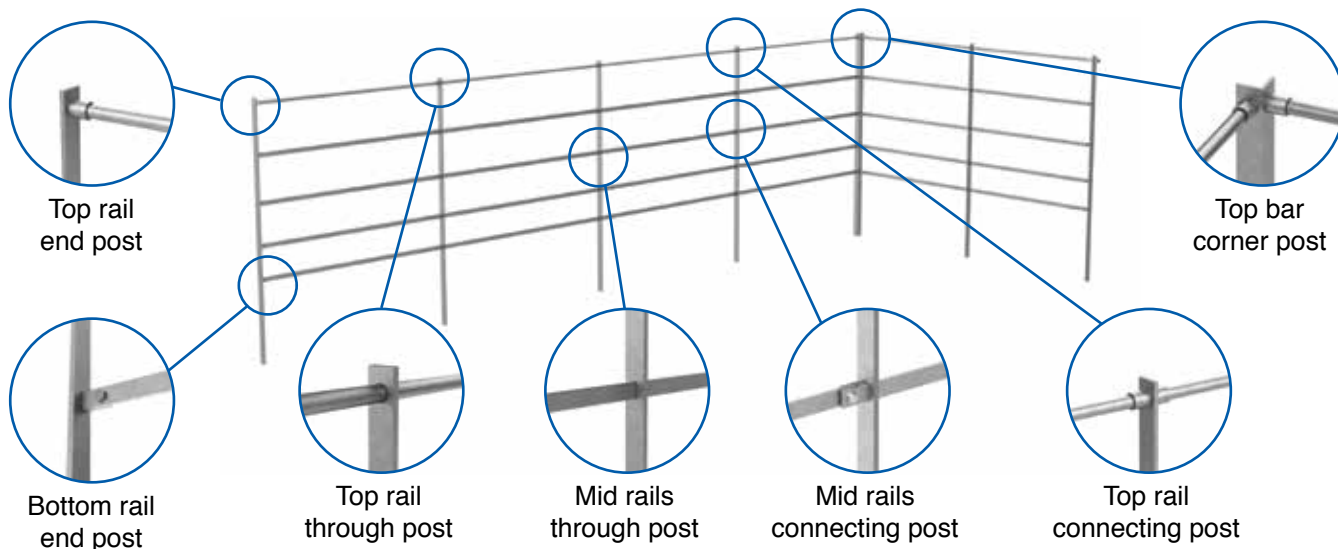

Post Corner Option



Pedestrian Or Drive Gate

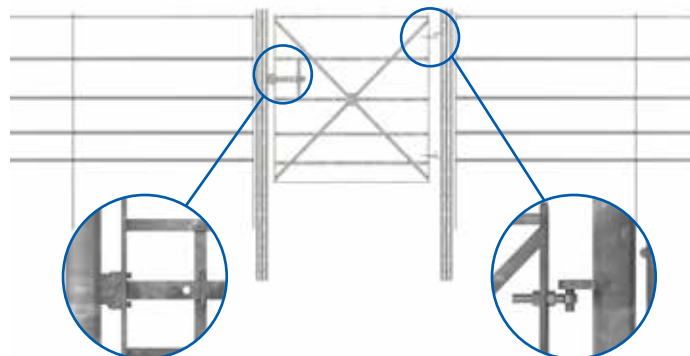

Gate latch

Adjustable gate hinge

Top Rail Bar / Tube



Description	Ø mm	Length m	Code
ERW Tube	20 x 1.5	6 - 6.1	30092016*
Solid Bar	20	6 - 6.1	300220

*We recommend painting / protective coating to improve longevity.

Flat Bar Rail



Size mm	Length m	Code
25 x 6	6 - 6.1	3003256

Fixings

Sleeve Joint Connector

For use with Ø 20mm bar & tube



Size mm	Code
60	6514920

Supplied with 2 grub screws. For connecting long runs of bar/tube.

Hex Full Nut



To Suit Ø mm	Code
M8	50HN08

BZP.

Hex Head Set Bolts



Ø mm	Length mm	Code
M8	20	50HS08X20
M8	30	50HS08X30

Plain Washers



To Suit Ø mm	Code
M8	50FW08

BZP.

Pedestrian Gate

With concrete-in posts

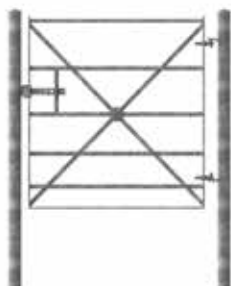

Gate Height m	Post Ø mm	Width Between Posts m	Code
1.15	76.1	1.2	55SLG12
1.15	76.1	1.2	55SLG12B*

Supplied with latch. Will fit an opening width from 1.19 - 1.23m between faces of the posts. *PPC gloss black RAL 9005.

Drive Gate

With concrete-in posts

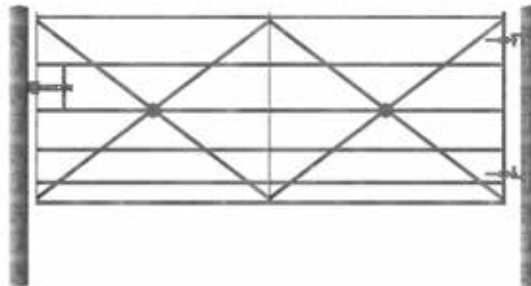

Gate Height m	Post Ø mm	Width Between Posts m	Code
1.15	114.3	3.0	55DLG12
1.15	114.3	3.0	55DLG12B*

Supplied with latch. Will fit an opening width from 2.97 - 3.07m between faces of the posts. *PPC gloss black RAL 9005.

Steel

Wrought Iron Components

Gate Hardware

Sliding Door Gear

Gate Automation

Mesh

Decking & Subframe

Flooring & Stair Treads

Handrailing

Fencing

Fixings



TESTED TO EN 1176

RoSPA bow top railings and gates are designed to give you peace of mind in terms of finger traps, head and neck traps, dog control, minimising clothes entanglement and are safe from sharp edges.

Specification:

- Single leaf gates open outwards only
- Self-closing left hand single leaf gates
- Rounded safety top panels
- Concrete-in gate posts
- Single gates are supplied with Locinox® Tiger hinge
- Galvanised or PPC black RAL 9005
- Tamper proof fixings
- Double leaf gates supplied with drop bars

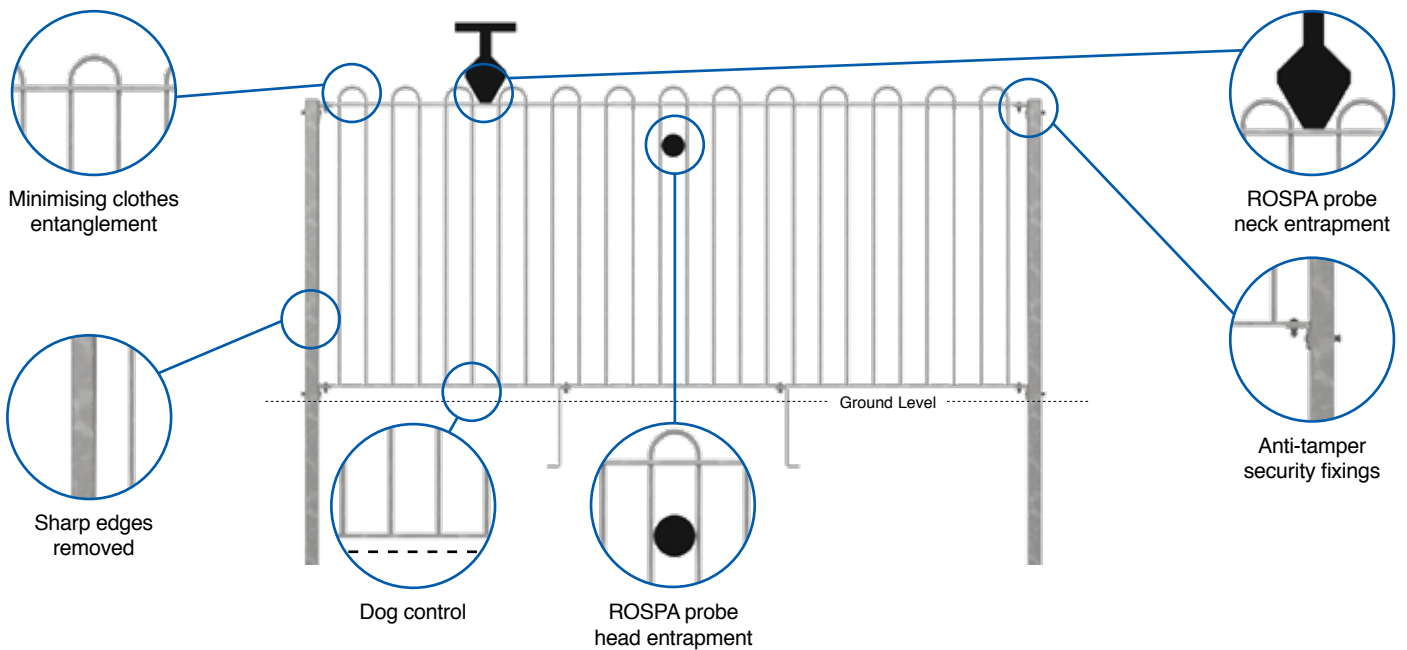

Price Per Metre Run With Concrete-In Posts

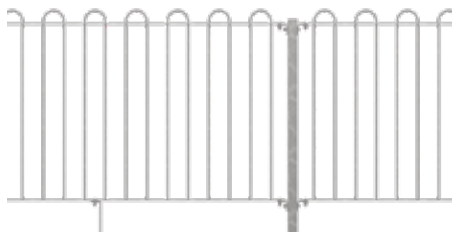

Fence Height m	Post Centres mm	Bar Ø mm	Galvanised Code	PPC Black Code
1.0	2710	12	51RBTC1012M	51RBTC1012BM
1.2	2710	12	51RBTC1212M	51RBTC1212BM

Includes panels, posts, cleats and fixings. Order support feet as an additional item. Please order an extra post to finish the run.

End Concrete-In Posts

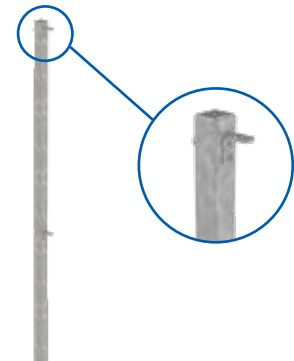

Fence H m	Post □ mm	Post H mm	To Suit Bolt mm	Galvanised Code	PPC Black Code
1.0	50	1505	M10 x 75	51RPCEP1050	51RPCEP1050B
1.2	50	1805	M10 x 75	51RPCEP1250	51RPCEP1250B

Includes post, cleats and fixings.

Self-Closing Left Hung Single Leaf Gate With Concrete-In Posts

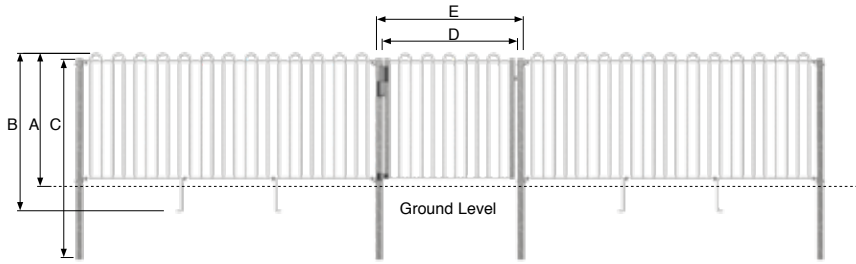

Supplied with Locinox® Tiger hinge



Fence Height (A) m	Panel Height mm	Bar Ø mm	Post □ mm	(B) mm	(C) mm	(D) mm	(E) mm	Galvanised Code	PPC Black Code
1.0	925	12	60	1225	1505	1220	1340	51RBTSLC101212L	51RBTSLC101212LB
1.2	1125	12	60	1425	1805	1220	1340	51RBTSLC121212L	51RBTSLC121212LB

Illustration showing a left hung hinge, front facing gate, opening outwards. Supplied with posts and fittings.

Double Leaf Gate With Concrete-In Posts

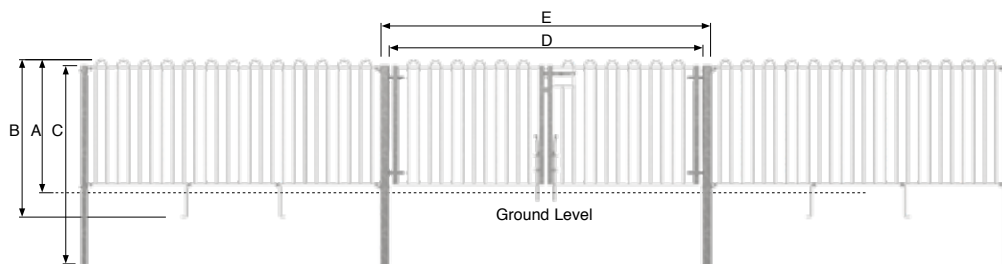

Fence Height (A) m	Panel Height mm	Bar Ø mm	Post □ mm	(B) mm	(C) mm	(D) mm	(E) mm	Galvanised Code	PPC Black Code
1.0	925	12	80	1225	1505	2840	3000	51RBDLC10123	51RBDLC10123B
1.2	1125	12	80	1425	1805	2840	3000	51RBDLC12123	51RBDLC12123B

Panel Without Posts

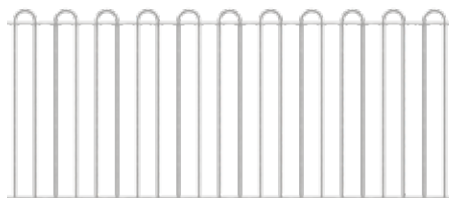

Fence Height m	Width mm	Bar Ø mm	Galvanised Code	PPC Black Code
1.0	2650	12	51RBTP1012	51RBTP1012B
1.2	2650	12	51RBTP1212	51RBTP1212B

Concrete-In Posts



Don't forget to order fast set post concrete code: 50CR20

Fence H m	Post □ mm	Post H mm	To Suit Bolt mm	Galvanised Code	PPC Black Code
1.0	50	1505	M10 x 75	51RPC1050	51RPC1050B
1.2	50	1805	M10 x 75	51RPC1250	51RPC1250B

Angle Cleat



Finish	Size mm	Code
Galvanised	50 x 50 x 25	51003
PPC Black	50 x 50 x 25	51003B

Cup Bolt



Description	Size mm	Code
Cup bolt to connect cleats & support feet	M10 x 35	5002CS10X35
Cup bolt to connect single gate post to panel	M10 x 80	5002CS10X80
Cup bolt to connect double gate post to panel	M10 x 100	5002CS10X100
Cup bolt to connect panels between posts	M10 x 75	5002CS10X75

Shear Nut

For use with cup bolts



Size	Code
M10	2302S10

Make Your Own Bow Tops



Steel

Wrought Iron Components

Gate Hardware

Sliding Door Gear

Gate Automation

Mesh

Decking & Subframe

Flooring & Stair Treads

Handrailing

Fencing

Fixings



Want to make your own bow tops? See below for details.

For Bow Top Components See Page 34

Round Bar

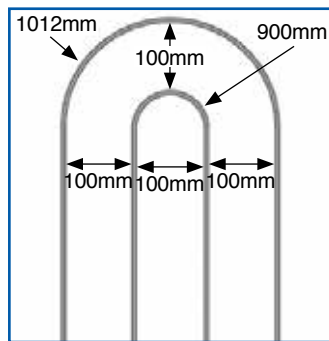
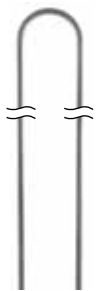

Inside Round Bar

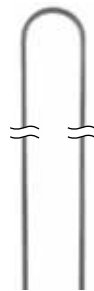

Outside Round Bar

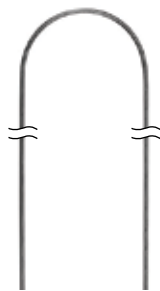

Square Bar



Sphere Welded On Ø 12mm Bar

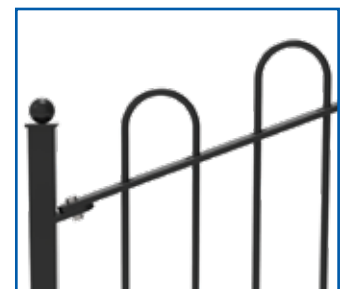
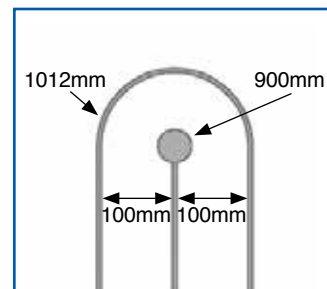

For Punched Bars See Page 32

18 Hole Flat Bar

Round holes to give 100mm gap



18 Hole Flat Bar

Square holes to give 100mm gap



20 Hole Hollow Section

Round holes to give 100mm gap



18 Hole Slotted Flat Bar

For slopes up to 20°



For Lugs, Brackets, Fixing Plates & Cleats See From Page 39

Lugs For Welding On



Slotted Lug With Round End



Slotted Fixing Bracket



Fixing Plate



Angle Cleat



Adjustable Angle Cleat



Post caps can be found from page 76.



Bow top is known for its distinctive rounded safety tops, a traditional design which can turn a perimeter fence into an attractive feature. It is usually seen in public and recreation areas, combining security with aesthetics. Used largely because of its economical and durable qualities but also because of its pleasing appearance, it is built to last and can be complemented with a range of forged heads and finials as an option to achieve a more decorative look. Hot dip galvanised to BS EN ISO 1461 after the fabrication process has been completed to ensure complete protection. Designed for quick installation, bow top fencing is a great solution to low security risk perimeter marking.

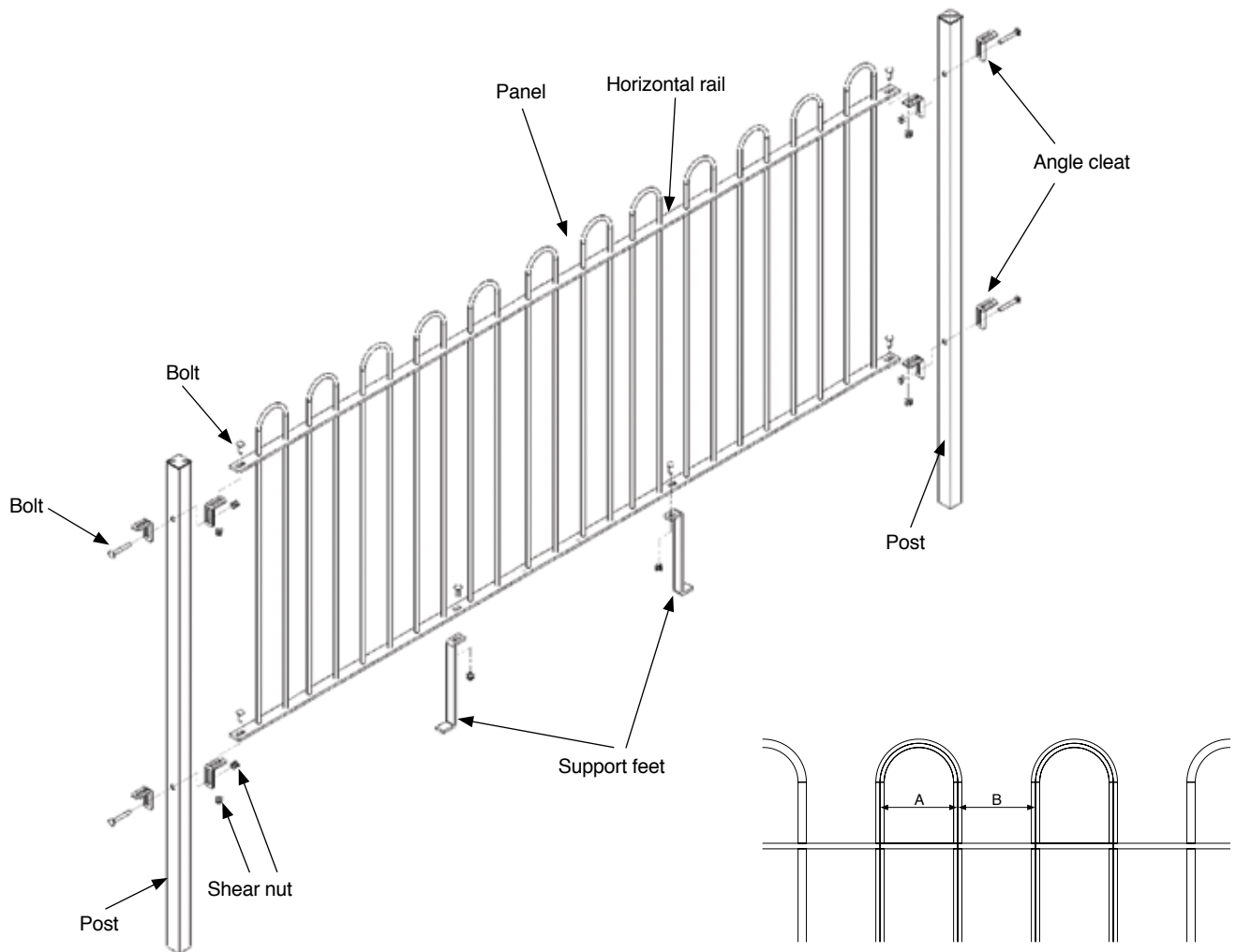

Fence Height m	Horizontal Rail mm	Post		Bows Ø mm	(A) mm	(B) mm	End Gap mm	Ground Clearance mm
		Size mm	Centres mm					
0.9	40 x 8	50 x 50 x 3	2810	12	112	112.0	87.0	75
1.2	40 x 8	50 x 50 x 3	2810	12	112	112.0	87.0	75
1.5	40 x 10	60 x 60 x 3	2820	16	116	105.7	97.7	75
1.8	40 x 10	60 x 60 x 3	2820	16	116	105.7	97.7	75
1.8	50 x 10	70 x 70 x 3	2830	20	120	102.3	92.3	75



Our metre runs include posts, panels, angle cleats and fixings. Please order support feet as an additional item.

Bow Top Panel Price Per Metre Run With Concrete-In Posts

Fence Height m	Post Centres mm	Bar Ø mm	Galvanised Code	PPC Black Code
0.9	2810	12	51BTC0912M	51BTC0912BM
1.2	2810	12	51BTC1212M	51BTC1212BM
1.5	2820	16	51BTC1516M	51BTC1516BM
1.8	2820	16	51BTC1816M	51BTC1816BM
1.8	2830	20*	51BTC1820M	51BTC1820BM

*This has been made from tube. Please order an extra post to finish the run.



Bow Top Panel Price Per Metre Run With Bolt-Down Posts

Fence Height m	Post Centres mm	Bar Ø mm	Galvanised Code	PPC Black Code
0.9	2810	12	51BTB0912M	51BTB0912BM
1.2	2810	12	51BTB1212M	51BTB1212BM
1.5	2820	16	51BTB1516M	51BTB1516BM
1.8	2820	16	51BTB1816M	51BTB1816BM
1.8	2830	20*	51BTB1820M	51BTB1820BM

*This has been made from tube. Please order an extra post to finish the run.



For Concrete-in and Bolt-down bow top gates see from page 632.



Scan here for the installation guide.

Posts

Please order an additional post to finish a bow top fence run.

End
Concrete-in

End
Bolt-down

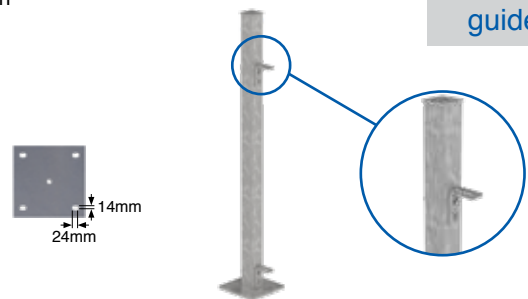
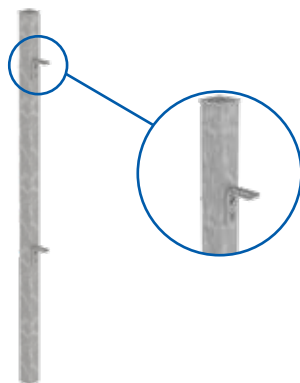

Don't forget to order fast set post code: 50CR20

Fence H m	Post □ mm	Post H mm	To Suit Bolt mm	Galvanised Code	PPC Black Code
0.9	50	1350	M10 x 75	51PCEP0950	51PCEP0950B
1.2	50	1750	M10 x 75	51PCEP1250	51PCEP1250B
1.5	60	2100	M10 x 80	51PCEP1560	51PCEP1560B
1.8	60	2400	M10 x 80	51PCEP1860	51PCEP1860B
1.8	70	2400	M10 x 90	51PCEP1870	51PCEP1870B

Includes post, cleats and fixings.

Fence H m	Post □ mm	To Suit Bolt mm	Base Plate ■ mm	Galvanised Code	PPC Black Code
0.9	50	M10 x 75	150	51PBEP0950	51PBEP0950B
1.2	50	M10 x 75	150	51PBEP1250	51PBEP1250B
1.5	60	M10 x 80	160	51PBEP1560	51PBEP1560B
1.8	60	M10 x 80	160	51PBEP1860	51PBEP1860B
1.8	70	M10 x 90	160	51PBEP1870	51PBEP1870B

10mm thick base plates. Includes post, cleats and fixings.



Bow Top Panels

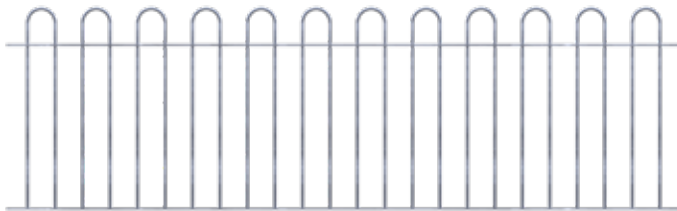

Fence Height m	Bar Ø mm	Panel Width mm	Galvanised Code	PPC Black Code
0.9	12	2750	51BTP0912	51BTP0912B
1.2	12	2750	51BTP1212	51BTP1212B
1.5	16	2750	51BTP1516	51BTP1516B
1.8	16	2750	51BTP1816	51BTP1816B
1.8	20*	2750	51BTP1820	51BTP1820B

*This has been made from tube.

Concrete-In Post



Fence H m	Post □ mm	Post H mm	To Suit Bolt mm	Galvanised Code	PPC Black Code
0.9	50	1350	M10 x 75	51PC0950	51PC0950B
1.2	50	1750	M10 x 75	51PC1250	51PC1250B
1.5	60	2100	M10 x 80	51PC1560	51PC1560B
1.8	60	2400	M10 x 80	51PC1860	51PC1860B
1.8	70	2400	M10 x 90	51PC1870	51PC1870B

Bolt-Down Post

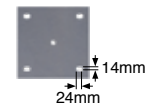

Fence H m	Post □ mm	To Suit Bolt mm	Base Plate mm	Galvanised Code	PPC Black Code
0.9	50	M10 x 75	150	51PB0950	51PB0950B
1.2	50	M10 x 75	150	51PB1250	51PB1250B
1.5	60	M10 x 80	160	51PB1560	51PB1560B
1.8	60	M10 x 80	160	51PB1860	51PB1860B
1.8	70	M10 x 90	160	51PB1870	51PB1870B

10mm thick base plates.

Angle Cleat



Height mm	Depth mm	Width mm	Galvanised Code	PPC Black Code
60	70	30	51001	51001B

Top slot 40 x 12mm. Bottom slot 50 x 12mm.

Support Foot



Height mm	Width mm	Galvanised Code	PPC Black Code
300	30	51002	51002B

Leg width 50mm. Fixing slot 25 x 12mm.

Touch Up Paint

Black gloss



Description	Size ml	Code
Brushable	125	29PC125TB
Spray	400	29PC400SB

Cup Square Bolt

For fixing panels



Ø x Length mm	Code
M10 x 35	5002CS10X35

Cup Square Bolt

For fixing posts



To Suit Post □ mm	Ø x Length mm	Code
50	M10 x 75	5002CS10X75
60	M10 x 80	5002CS10X80
70	M10 x 90	5002CS10X90

Shear Nut



To Suit Ø mm	Code
M10	2302S10



General Gate Specification:

- Galvanised or PPC black RAL 9005
- Rounded safety top panels
- Concrete-in gate posts
- Tip latch with 0.9 & 1.2m high gates
- Slide latch with padlock holes for 1.5 & 1.8m high gates
- Security collars to stop removal of gates
- Full technical spec available online

Additions For Single Leaf Gates:

- Gates open inwards 105°
- 1.5 & 1.8m high single leaf gates are lockable
- Reversible gate catch

Additions For Double Leaf Gates:

- Gates open inwards & outwards 105°
- Double leaf gates supplied with drop bars
- All double leaf gates are lockable

Single Leaf Gate & Posts

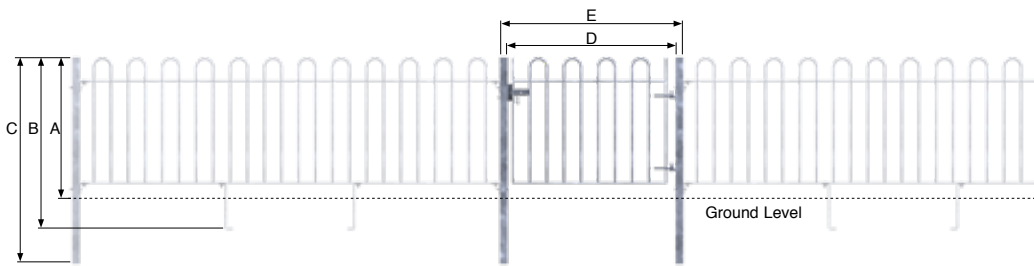

Our galvanised railings can be powder coated to your choice of colour.

Fence Height (A) m	Panel Height mm	Bar Ø mm	Post □ mm	(B) mm	(C) mm	(D) mm	(E) mm	Galvanised Code	PPC Black Code
0.9	825	12	50	1125	1350	1104	1204	51SLC09121	51SLC09121B
1.2	1125	12	50	1425	1750	1104	1204	51SLC12121	51SLC12121B
1.5	1425	16	60	1725	2100	1158	1278	51SLC15161	51SLC15161B
1.8	1725	16	60	2025	2400	1162	1282	51SLC18161	51SLC18161B
1.8	1725	20*	70	2025	2400	1200	1340	51SLC18201	51SLC18201B

Illustration showing a left hung hinge, front facing gate. *Made from tube.

Double Leaf Gate & Posts

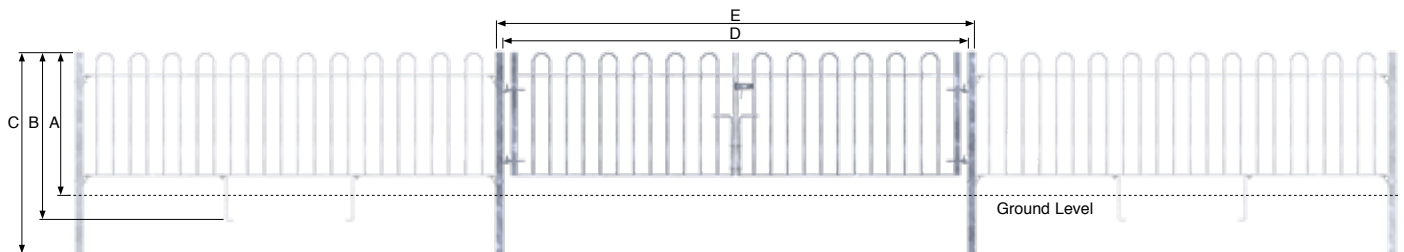

Fence Height (A) m	Panel Height mm	Bar Ø mm	Post □ mm	(B) mm	(C) mm	(D) mm	(E) mm	Galvanised Code	PPC Black Code
0.9	825	12	50	1125	1350	3104	3204	51DLC09123	51DLC09123B
1.2	1125	12	50	1425	1750	3104	3204	51DLC12123	51DLC12123B
1.5	1425	16	60	1725	2100	3148	3268	51DLC15163	51DLC15163B
1.8	1725	16	70	2025	2400	3178	3318	51DLC18163	–

For padlock use code: 51PLK50L.



General Gate Specification:

- Galvanised or PPC black RAL 9005
- Rounded safety top panels
- Bolt-down gate posts
- Tip latch with 0.9 & 1.2m high gates
- Slide latch with padlock holes for 1.5 & 1.8m high gates
- Security collars to stop removal of gates
- Full technical spec available online

Additions For Single Leaf Gates:

- Gates open inwards 105°
- 1.5 & 1.8m high single gates are lockable
- Reversible gate catch

Additions For Double Leaf Gates:

- Gates open inwards & outwards 105°
- Double leaf gates supplied with drop bars
- All double gates are lockable

Single Leaf Gate & Posts

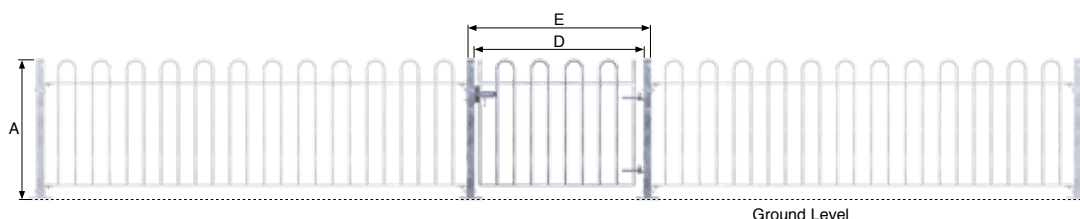

Other sizes available to order.

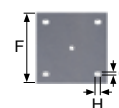

Fence Height (A) m	Panel Height mm	Bar Ø mm	Post □ mm	(D) mm	(E) mm	(F) ■ mm	(G) x (H) mm	Galvanised Code	PPC Black Code
0.9	825	12	50	1104	1204	150	14 x 24	51SLB09121	51SLB09121B
1.2	1125	12	50	1104	1204	150	14 x 24	51SLB12121	51SLB12121B
1.5	1425	16	60	1158	1278	160	14 x 24	51SLB15161	51SLB15161B
1.8	1725	16	60	1162	1282	160	14 x 24	51SLB18161	–
1.8	1725	20*	70	1200	1340	160	14 x 24	–	51SLB18201B

Please note the base plate will add an extra 10mm height to the fence. Illustration showing a left hung hinge, front facing gate. *Made from tube.

Double Leaf Gate & Posts

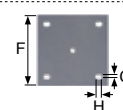
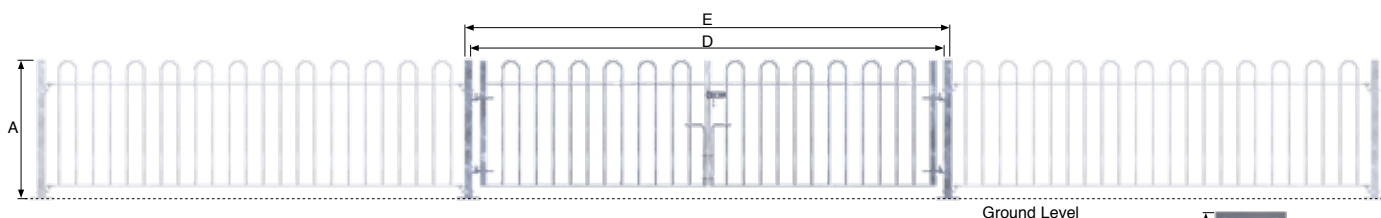

Fence Height (A) m	Panel Height mm	Bar Ø mm	Post □ mm	(D) mm	(E) mm	(F) ■ mm	(G) x (H) mm	Galvanised Code	PPC Black Code
0.9	825	12	50	3104	3204	150	14 x 24	51DLB09123	51DLB09123B
1.2	1125	12	50	3104	3204	150	14 x 24	51DLB12123	51DLB12123B
1.5	1425	16	60	3148	3268	160	14 x 24	51DLB15163	51DLB15163B
1.8	1725	16	70	3178	3318	160	14 x 24	51DLB18163	51DLB18163B
1.8	1725	20*	70	3192	3332	160	14 x 24	–	51DLB18203B

Please note the base plate will add an extra 10mm height to the fence. *Made from tube. For padlock use code: 51PLK50L.

Choose from 5 styles

- Steel
- Wrought Iron Components
- Gate Hardware
- Sliding Door Gear
- Gate Automation
- Mesh
- Decking & Subframe
- Flooring & Stair Treads
- Handrailing
- Fencing
- Fixings



Our ready-to-install gates and fencing panels provide you with a choice of five railheads and easy, trouble free installation. These systems come in galvanised or PPC black but can also be powder coated to any RAL colour of your choice.

General Gate Specification:

- Galvanised or PPC black RAL 9005
- To suit 0.9 or 1.2m fence height
- Concrete-in or bolt-down posts
- Ø 12mm bar
- Tip latch
- Security collars to stop removal of gates

Additions For Single Leaf Gates:

- Gates open inwards 105°
- Reversible gate catch

Additions For Double Leaf Gates:

- Gates open inwards & outwards 105°
- Double leaf gates supplied with drop bars
- All double leaf gates are lockable



Page 635



Page 636



Page 637



Page 638



Page 639

Price Per Metre Run With Concrete-In Posts

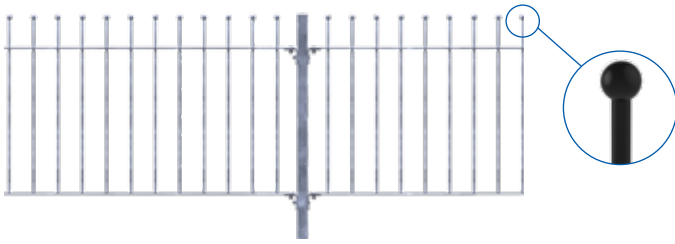

Fence Height m	Galvanised Code	PPC Black Code
0.9	51STC0912M	51STC0912BM
1.2	51STC1212M	51STC1212BM

Includes panels, posts, cleats and fixings. Please order an extra post to finish the run.

Concrete-In End Posts

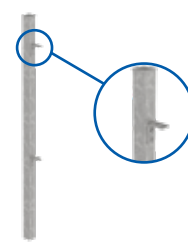

Fence Height m	Post □ mm	Post H mm	Galvanised Code	PPC Black Code
0.9	50	1350	51PCEP0950	51PCEP0950B
1.2	50	1750	51PCEP1250	51PCEP1250B

Includes post, cleats and fixings.

Price Per Metre Run With Bolt-Down Posts



Fence Height m	Galvanised Code	PPC Black Code
0.9	51STB0912M	51STB0912BM
1.2	51STB1212M	51STB1212BM

Includes panels, posts, cleats and fixings. Please order an extra post to finish the run.

Bolt-Down End Posts

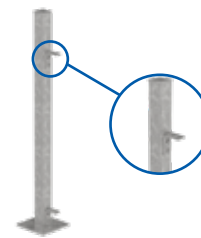

Fence Height m	Post □ mm	Post H mm	Galvanised Code	PPC Black Code
0.9	50	1350	51PBEP0950	51PBEP0950B
1.2	50	1750	51PBEP1250	51PBEP1250B

Includes post, cleats and fixings.

Concrete-In Single Leaf Gate

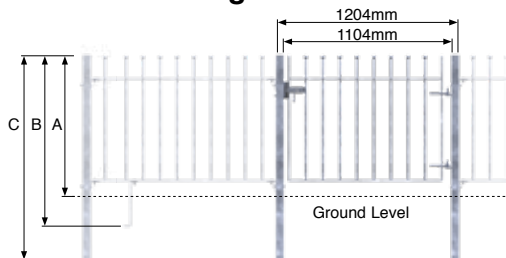
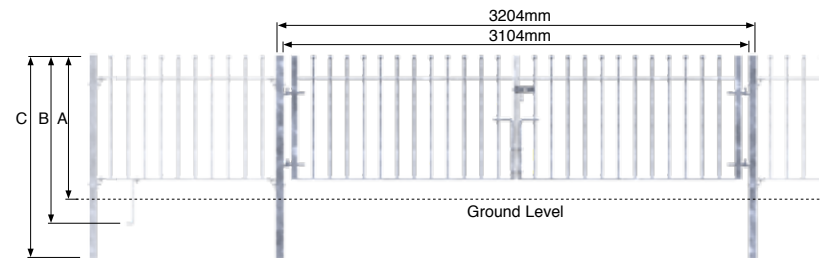

Illustration showing a left hung hinge, front facing gate.

Concrete-In Double Leaf Gate



Fence Height (A) m	Panel Height mm	Post □ mm	(B) mm	(C) mm	Single Leaf Galvanised Code	Single Leaf PPC Black Code	Double Leaf Galvanised Code	Double Leaf PPC Black Code
0.9	825	50	1125	1350	51SLCST09121	51SLCST09121B	51DLCST09123	51DLCST09123B
1.2	1125	50	1425	1750	51SLCST12121	51SLCST12121B	51DLCST12123	51DLCST12123B

If a padlock is required for double gate use code: **51PLK50L**.

Bolt-Down Single Leaf Gate

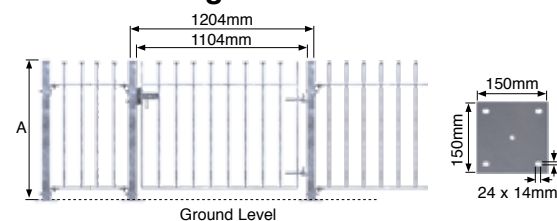
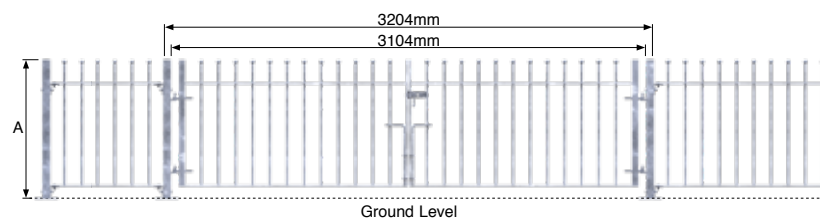

Illustration showing a left hung hinge, front facing gate.

Bolt-Down Double Leaf Gate



Fence Height (A) m	Panel Height mm	Post □ mm	Single Leaf Galvanised Code	Single Leaf PPC Black Code	Double Leaf Galvanised Code	Double Leaf PPC Black Code
0.9	825	50	51SLBST09121	51SLBST09121B	51DLBST09123	—
1.2	1125	50	51SLBST12121	51SLBST12121B	—	51DLBST12123B

Please note the base plate will add an extra 10mm height to the fence. If a padlock is required for double gate use code: **51PLK50L**.

Steel
Wrought Iron
Gate
Hardware
Sliding
Door Gear
Gate
Automation
Mesh
Decking & Subframe
Flooring & Stair Treads
Handrailing
Fencing
Fixings

Price Per Metre Run With Concrete-In Posts

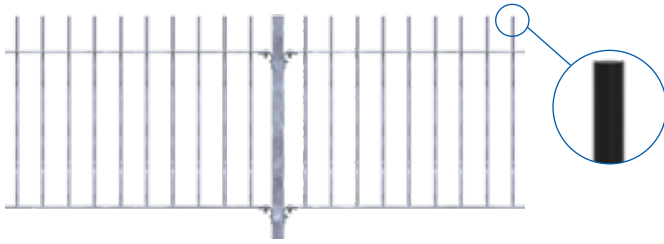

Fence Height m	Galvanised Code	PPC Black Code
0.9	51VBC0912M	51VBC0912BM
1.2	51VBC1212M	51VBC1212BM

Includes panels, posts, cleats and fixings. Please order an extra post to finish the run.

Concrete-In End Posts

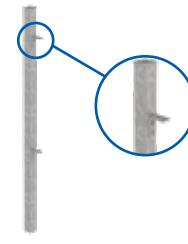

Fence Height m	Post □ mm	Post H mm	Galvanised Code	PPC Black Code
0.9	50	1350	51PCEP0950	51PCEP0950B
1.2	50	1750	51PCEP1250	51PCEP1250B

Includes post, cleats and fixings.

Price Per Metre Run With Bolt-Down Posts



Fence Height m	Galvanised Code	PPC Black Code
0.9	51VBB0912M	51VBB0912BM
1.2	51VBB1212M	51VBB1212BM

Includes panels, posts, cleats and fixings. Please order an extra post to finish the run.

Bolt-Down End Posts

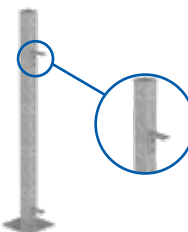

Fence Height m	Post □ mm	Post H mm	Galvanised Code	PPC Black Code
0.9	50	1350	51PBEP0950	51PBEP0950B
1.2	50	1750	51PBEP1250	51PBEP1250B

Includes post, cleats and fixings.

Concrete-In Single Leaf Gate

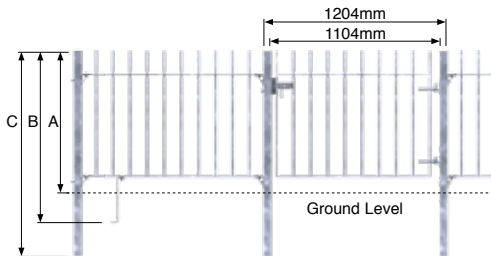

Concrete-In Double Leaf Gate

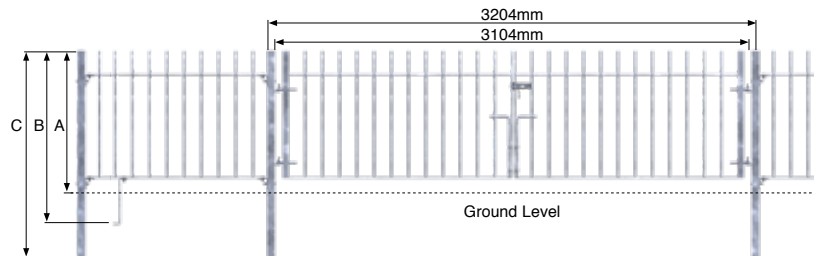
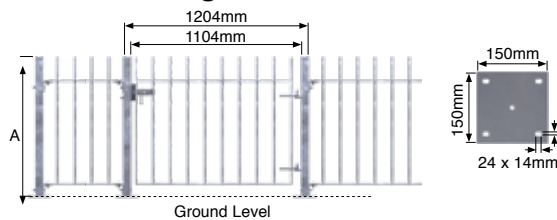

Illustration showing a left hung hinge, front facing gate.

Fence Height (A) m	Panel Height mm	Post □ mm	(B) mm	(C) mm	Single Leaf Galvanised Code	Single Leaf PPC Black Code	Double Leaf Galvanised Code	Double Leaf PPC Black Code
0.9	825	50	1125	1350	51SLCVB09121	51SLCVB09121B	—	51DLCVB09123B
1.2	1125	50	1425	1750	51SLCVB12121	51SLCVB12121B	51DLCVB12123	51DLCVB12123B

If a padlock is required for double gate use code: 51PLK50L.

Bolt-Down Single Leaf Gate



Bolt-Down Double Leaf Gate

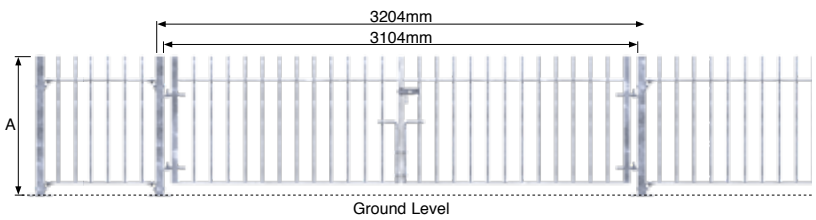

Illustration showing a left hung hinge, front facing gate.

Fence Height (A) m	Panel Height mm	Post □ mm	Single Leaf Galvanised Code	Single Leaf PPC Black Code	Double Leaf Galvanised Code	Double Leaf PPC Black Code
0.9	825	50	51SLBVB09121	—	51DLBVB09123	—
1.2	1125	50	51SLBVB12121	51SLBVB12121B	51DLBVB12123	51DLBVB12123B

Please note the base plate will add an extra 10mm height to the fence. If a padlock is required for double gate use code: 51PLK50L.



For railhead code: 0513052 see page 65.

Price Per Metre Run With Concrete-in Posts

End Post

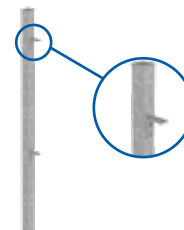

Fence Height m	Galvanised Code	PPC Black Code
1.2	51RTC1212M	51RTC1212BM

Post	Fence Height m	Post □ mm	Post H mm	Galvanised Code	PPC Black Code
End	1.2	50	1750	51PCEP1250	51PCEP1250B

Includes panels, posts, cleats and fixings. Please order an extra post to finish the run.

Includes post, cleats and fixings.

Single Leaf Gate

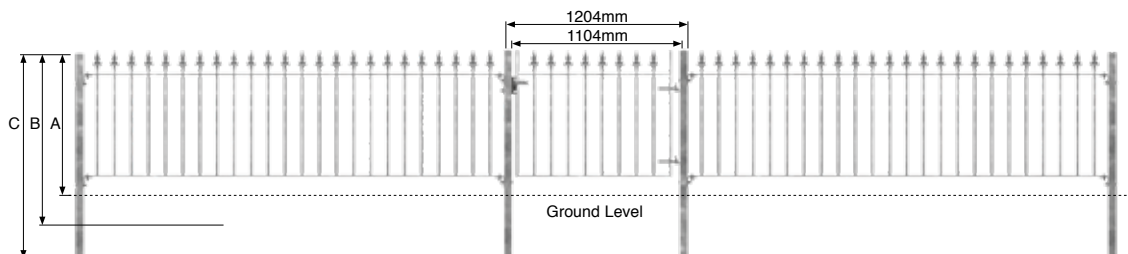
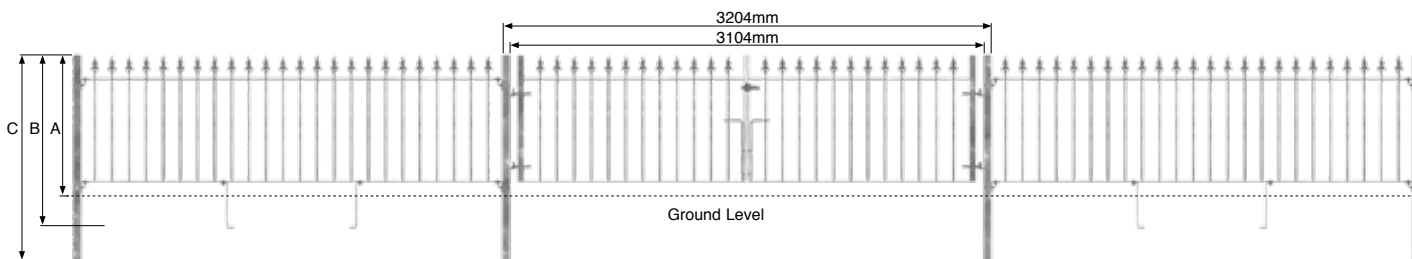

Illustration showing a left hung hinge, front facing gate.

Fence Height (A) m	Panel Height mm	Post □ mm	(B) mm	(C) mm	Single Leaf Galvanised Code	Single Leaf PPC Black Code
1.2	1125	50	1425	1750	51SLCR12121	51SLCR12121B

Double Leaf Gate



Fence Height (A) m	Panel Height mm	Post □ mm	(B) mm	(C) mm	Double Leaf Galvanised Code	Double Leaf PPC Black Code
1.2	1125	50	1425	1750	51DLCR12123	51DLCR12123B

For padlock use code: 51PLK50L.

Our galvanised railings can be powder coated to your choice of colour.

- Steel
- Wrought Iron Components
- Gate Hardware
- Sliding Door Gear
- Gate Automation
- Mesh
- Decking & Subframe
- Flooring & Stair Treads
- Handrailing
- Fencing
- Fixings



For railhead code: 0513092 see page 70.

Price Per Metre Run With Concrete-In Posts

End Post

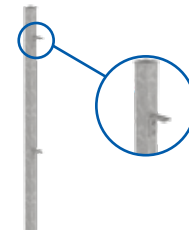

Fence Height m	Galvanised Code	PPC Black Code
1.2	51CTC1212M	51CTC1212BM

Post	Fence Height m	Post □ mm	Post H mm	Galvanised Code	PPC Black Code
End	1.2	50	1750	51PCEP1250	51PCEP1250B

Includes panels, posts, cleats and fixings. Please order an extra post to finish the run.

Includes post, cleats and fixings.

Single Leaf Gate

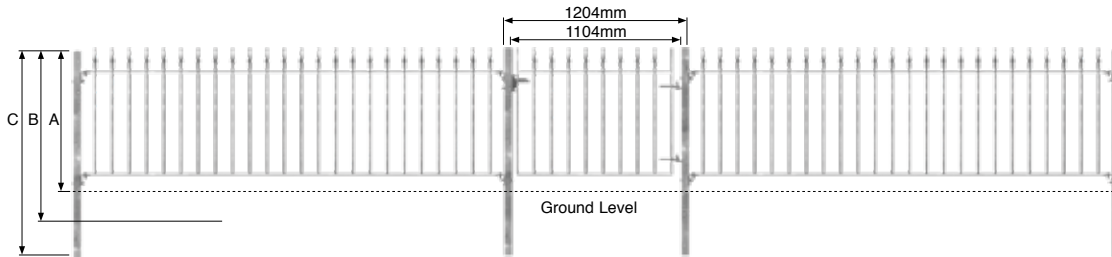
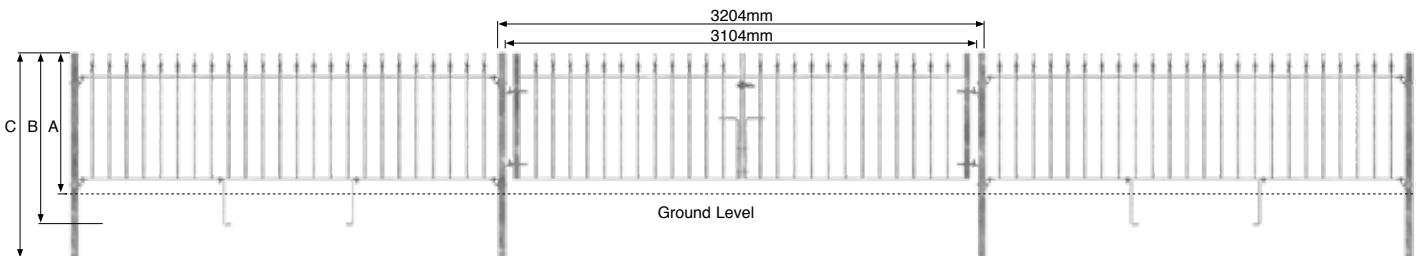

Illustration showing a left hung hinge, front facing gate.

Fence Height (A) m	Panel Height mm	Post □ mm	(B) mm	(C) mm	Single Leaf Galvanised Code	Single Leaf PPC Black Code
1.2	1125	50	1425	1750	51SLCC12121	51SLCC12121B

Double Leaf Gate



Fence Height (A) m	Panel Height mm	Post □ mm	(B) mm	(C) mm	Double Leaf Galvanised Code	Double Leaf PPC Black Code
1.2	1125	50	1425	1750	51DLCC12123	51DLCC12123B

For padlock use code: 51PLK50L.

Our galvanised railings can be powder coated to your choice of colour.



For railhead code: 051301204 see page 67.

Price Per Metre Run With Concrete-In Posts

End Post

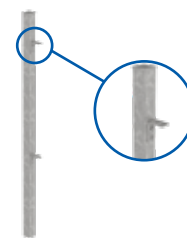

Fence Height m	Galvanised Code	PPC Black Code
1.2	51FTC1212M	51FTC1212BM

Includes panels, posts, cleats and fixings. Please order an extra post to finish the run.

Post	Fence Height m	Post □ mm	Post H mm	Galvanised Code	PPC Black Code
End	1.2	50	1750	51PCEP1250	51PCEP1250B

Includes post, cleats and fixings.

Single Leaf Gate

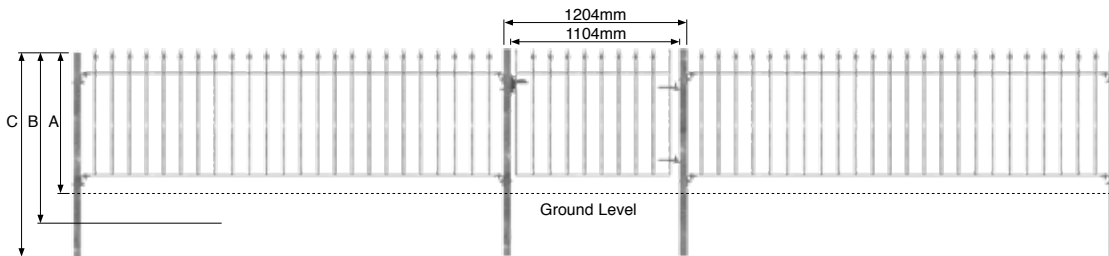
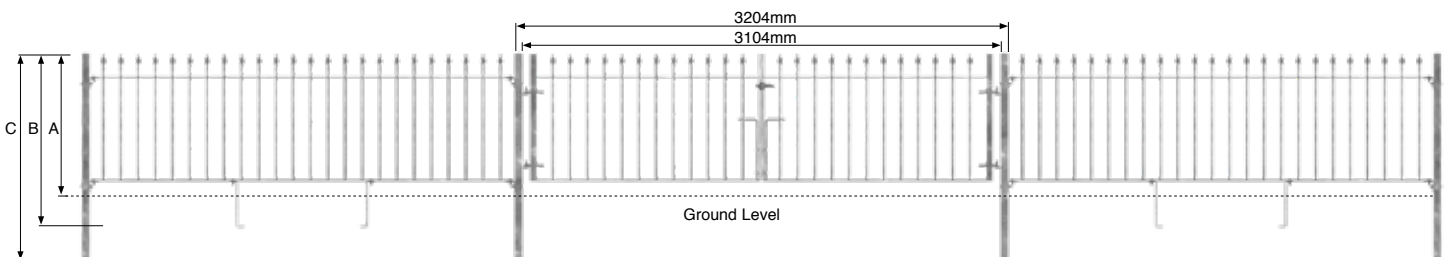

Illustration showing a left hung hinge, front facing gate.

Fence Height (A) m	Panel Height mm	Post □ mm	(B) mm	(C) mm	Single Leaf Galvanised Code	Single Leaf PPC Black Code
1.2	1125	50	1425	1750	51SLCF12121	51SLCF12121B

Double Leaf Gate



Fence Height (A) m	Panel Height mm	Post □ mm	(B) mm	(C) mm	Double Leaf Galvanised Code	Double Leaf PPC Black Code
1.2	1125	50	1425	1750	51DLCF12123	51DLCF12123B

For padlock use code: 51PLK50L.

Our galvanised railings can be powder coated to your choice of colour.

Steel

Sphere Top Panel

Without posts

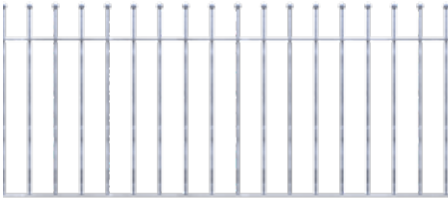

Fence Height m	Galvanised Code	PPC Black Code
0.9	51STP0912	51STP0912B
1.2	51STP1212	51STP1212B

Width 2750mm.

Vertical Bar Panel

Without posts

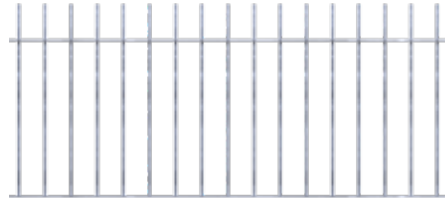

Fence Height m	Galvanised Code	PPC Black Code
0.9	51VBP0912	51VBP0912B
1.2	51VBP1212	51VBP1212B

Width 2750mm.

Fleur De Lis Panel

Without posts

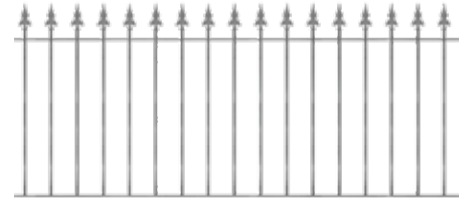

Fence Height m	Galvanised Code	PPC Black Code
1.2	51RTP1212	51RTP1212B

Width 2750mm.

Wrought Iron Components

Gate Hardware

Forest Panel

Without posts

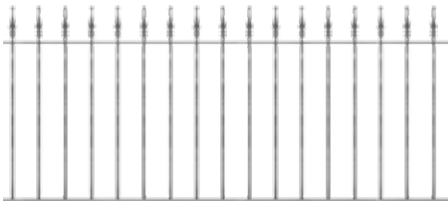

Fence Height m	Galvanised Code	PPC Black Code
1.2	51CTP1212	51CTP1212B

Width 2750mm.

Flame Panel

Without posts



Fence Height m	Galvanised Code	PPC Black Code
1.2	51FTP1212	51FTP1212B

Width 2750mm.

Touch Up Paint

Black gloss



Description	Size ml	Code
Brushable	125	29PC125TB
Spray	400	29PC400SB

Sliding Door Gear

Gate Automation

Concrete-In



Fence Height m	Post □ mm	Post H mm	To Suit Bolt mm	Galvanised Code	PPC Black Code
0.9	50	1350	M10 x 75	51PC0950	51PC0950B
1.2	50	1750	M10 x 75	51PC1250	51PC1250B

Bolt-Down

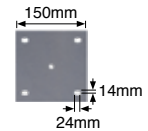

Fence Height m	Post □ mm	To Suit Bolt mm	Galvanised Code	PPC Black Code
0.9	50	M10 x 75	51PB0950	51PB0950B
1.2	50	M10 x 75	51PB1250	51PB1250B

10mm thick base plates.

Mesh

Decking & Subframe

Angle Cleat



Height mm	Depth mm	Width mm	Galvanised Code	PPC Black Code
60	70	30	51001	51001B

Top fixing slot 40 x 12mm. Bottom fixing slot 50 x 12mm.

Support Foot



Height mm	Width mm	Leg Width mm	Galvanised Code	PPC Black Code
300	30	50	51002	51002B

Fixing slot 25 x 12mm.

Handrailing

Cup Square Bolt

For fixing panels



Ø x Length mm	Code
M10 x 35	5002CS10X35

Cup Square Bolt

For fixing posts



To Suit Post □ mm	Ø x Length mm	Code
50	M10 x 75	5002CS10X75
60	M10 x 80	5002CS10X80
70	M10 x 90	5002CS10X90

Shear Nut



To Suit Ø mm	Code
M10	2302S10

Fencing

Fixings



Our galvanised railings can be powder coated to your choice of colour.



Steel

Wrought Iron Components

Gate Hardware

Sliding Door Gear

Gate Automation

Mesh

Decking & Subframe

Flooring & Stair Treads

Handrailing

Fencing

Fixings

Bow Top Panel

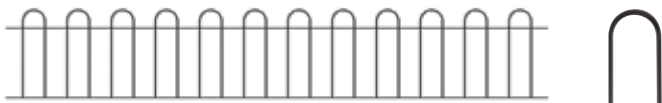

Panel Height mm	Panel Width mm	Galvanised Code	PPC Black Code
465	2750	51WBTP0512	51WBTP0512B

Sphere Top Panel

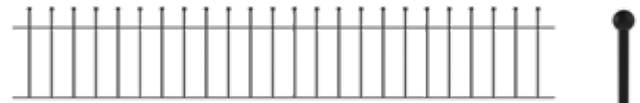

Panel Height mm	Panel Width mm	Galvanised Code	PPC Black Code
465	2750	51WSTP0512	51WSTP0512B

Vertical Bar Panel

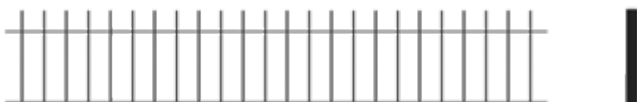

Panel Height mm	Panel Width mm	Galvanised Code	PPC Black Code
465	2750	51WVBP0512	51WVBP0512B

Forest Panel

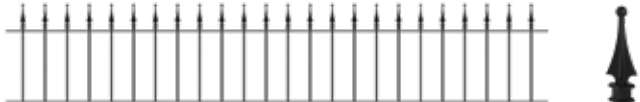

Panel Height mm	Panel Width mm	Galvanised Code	PPC Black Code
496	2750	51WCTP0512	51WCTP0512B

Concrete-In Posts

End / Mid



Galvanised Code	PPC Black Code
51PC0540	51PC0540B

40 x 10mm & Ø 10mm fixing holes. To give overall height of 500mm.

Corner



Galvanised Code	PPC Black Code
51PCC0540	51PCC0540B

40 x 40mm & Ø 10mm fixing holes. To give overall height of 500mm.

Bolt-Down Posts

End / Mid



Galvanised Code	PPC Black Code
51PB0540	51PB0540B

40 x 10mm & Ø 10mm fixing holes. To give overall height of 500mm.

Corner



Galvanised Code	PPC Black Code
51PBC0540	51PBC0540B

40 x 40mm & Ø 10mm fixing holes. To give overall height of 500mm.

Angle Cleat



H x D x W mm	Galvanised Code	PPC Black Code
40 x 40 x 25	51004	51004B

5mm thickness.

Adjustable Support Bracket



W x D mm	Code
156 x 63	05LUG14

12mm thickness.

Semi Gloss Black Touch Up Paint

RAL 9005



ml	Code
400	29RSBS

Fixings

Description	Size	Code
Hexagonal bolt	M8 x 30mm	5002HS08X30
Hexagonal bolt	M8 x 60mm	5002HS08X60
Washer to suit M8 hexagonal bolt	-	5002FW08

Description	Size	Code
Hexagonal nut to suit M8 hexagonal bolt	-	5002HN08
Cup square bolt	M8 x 25mm	5002CS08X25
Shear nut to suit M8 cup square bolt	-	47032C

Chestnut Pale Fencing



Chestnut pale fencing has been widely used in agricultural applications for many years. Cost effective and easy to erect, it can be re-rolled after use making it an ideal solution for any temporary fencing requirements you have.

Chestnut Pale Fence

With 3 wires



Height mm	Length m	Gaps between pales mm	Code
914	9.14	100	080657
1219	9.14	100	080658

Sweet chestnut.

Staples

Applications

- Heavily galvanised fencing staples to hold fencing firmly in place throughout its life



Chestnut fencing compatible with chain link posts see page 644.

Size mm	Pack kg	Code
30 x 3.55	20.0	09S3020
40 x 4.00	10.0	09S4010
40 x 4.00	20.0	09S4020

Wire Netting



Hexagonal Wire Netting

Height mm	Length m	Mesh mm	Gauge g	Code
600	50	31	19	090206311950
900	10	13	22	090209132210
900	10	25	20	090209252010
900	25	25	20	090209252025
900	25	13	22	090209132225
900	10	50	19	090209501910
900	50	25	20	090209252050
1200	25	25	20	090212252025
1200	25	50	19	090212501925
1800	50	25	20	090218252050
1800	50	50	19	090218501950

Budget Wire Netting

Height mm	Length m	Mesh mm	Kg	Code
1050	50	31	19	080068

Wire



Ø mm	Length m	Code
2.50	640	040201264
3.15	400	040201315
4.00	250	040201400
5.00	160	040201500



Netting fasteners & tools from page 648.



Zenturo® Super Gabion Fencing



From a closed partition to a garden feature, Zenturo® Super is versatile, easy to install and can be configured in many different ways to offer both privacy and security. With a combination of strength and natural beauty the panels can be filled with a variety of natural materials that will allow you to build walls and boundaries and are available in a contemporary anthracite RAL 7016.



Uses:

- Residential developments, gardens & communal areas
- Climbing plants and sedums to create a living wall
- Decorative natural items such as pebbles, stones & bark
- Rocks or plants are not supplied

Gabion Fence

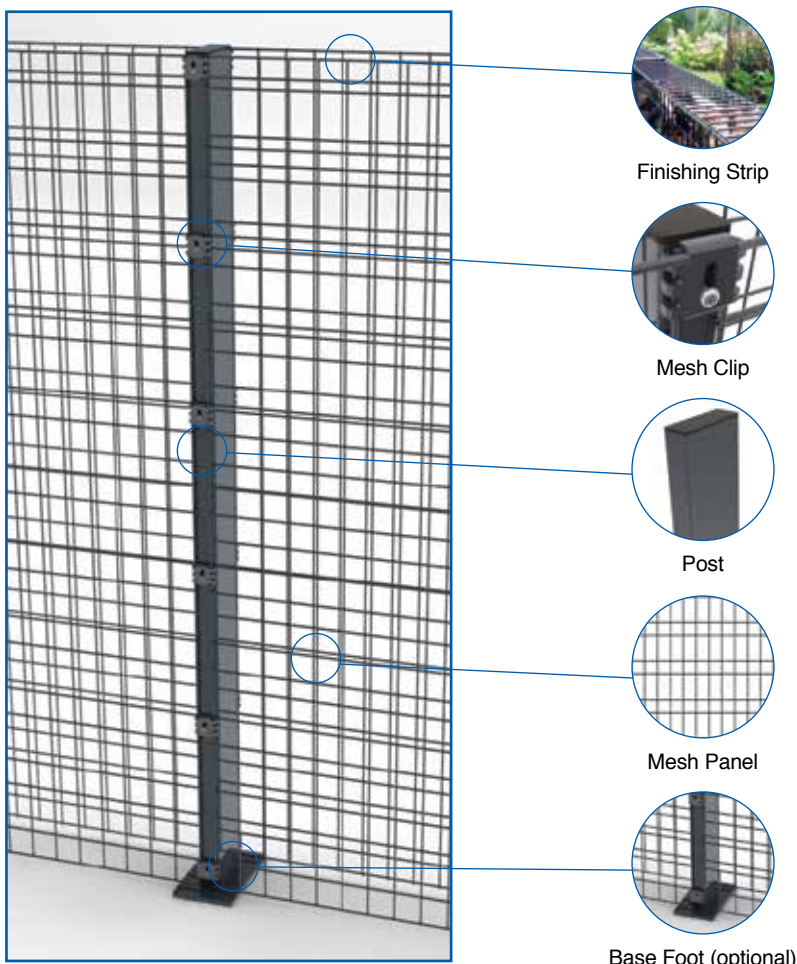

Finishing Strip



Mesh Clip



Post

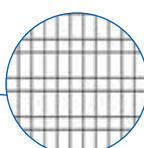

Mesh Panel



Base Foot (optional)

Concrete-In Price Per Metre



Fence Height m	Code
1	56ZS10AM
2	56ZS20AM

Includes 1 x post, 2 x panels, 8 x fixing kits, 25 x distance holders and 1 x finishing strip. Please order an extra post to finish the run. Posts will need to be cut to size.

Concrete-In Post



Post Height m	Post Size mm	Code
2.7	120 x 40	56ZSBOX20A

Supplied with fixings. Post centres 2m max. Please order an additional post to finish the run.

Mesh Panels

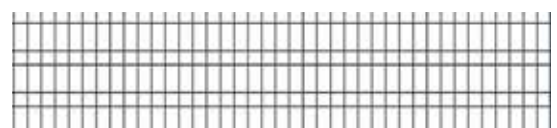

Panel H x W mm	Mesh mm	Code
950 x 2000	100 x 50 / 50 x 50	56ZS10A
2000 x 2000	100 x 50 / 50 x 50	56ZS20A

- Steel
- Wrought Iron Components
- Gate Hardware
- Sliding Door Gear
- Gate Automation
- Mesh
- Decking & Subframe
- Flooring & Stair Treads
- Handrailing
- Fencing
- Fixings

Steel

Wrought Iron
ComponentsGate
HardwareSliding
Door GearGate
Automation

Mesh

Decking &
SubframeFlooring &
Stair Treads

Handrailing

Fencing

Fixings



For attaching chain link to line wire, see our range of hog rings & tools on page 609.

A well proven popular, versatile and easy to erect fencing suitable for a wide variety of applications. From a simple boundary marker to a permanent secure fence, there will be a specification of chain link suited to the purpose.

Galvanised Chain Link Rolls

Fence Height m	Roll m	Mesh □ mm	Wire Ø mm	Supplied with Line Wires	Code
0.90	25.0	50	2.50	2	450209250
0.90	25.0	50	3.00	2	450209300
1.20	25.0	50	2.50	3	450212250
1.20	25.0	50	3.00	3	450212300
1.80	25.0	50	2.50	3	450218250
1.80	25.0	50	3.00	3	450218300
2.40	12.5	50	3.00	4	450224300



PVC Green (Galvanised Core) Chain Link Rolls

Fence Height m	Roll m	Mesh □ mm	Wire Ø mm	Supplied with Line Wires	Code
0.90	25.0	50	3.15	2	452509315
1.20	25.0	50	3.15	3	452512315
1.80	25.0	50	3.15	3	452518315
1.80	25.0	50	3.55	3	452518355
2.15	12.5	50	3.15	0	4525215315
2.40	12.5	50	3.15	5	452524315B
2.75	12.5	20	3.15	65m coil	4525275315

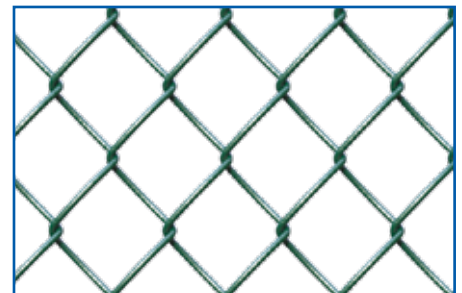

PVC Black (Galvanised Core) Chain Link Rolls

Fence Height m	Roll m	Mesh □ mm	Wire Ø mm	Supplied with Line Wires	Code
0.90	25.0	50	3.15	2	45250950315
1.80	25.0	50	3.15	3	45251850315



You can order online 24 hours a day, 7 days a week. Visit our website: www.fhbrundle.co.uk

Galvanised Line Wire



PVC Green Line Wire Galvanised core



Staples



Strainer



APPLICATIONS

- Heavily galvanised fencing staples to hold fencing firmly in place throughout its life

Ø mm	Length m	Code
3	50	04L30050
3	75	04L30075
3	100	04L300100

Ø mm	Code
4	042825400300G

397m length.

Size mm	Pack kg	Code
40 x 4.00	10	09S4010
30 x 3.55	20	09S3020

Model	Code
Economy	0702009



End Post

Concrete-in

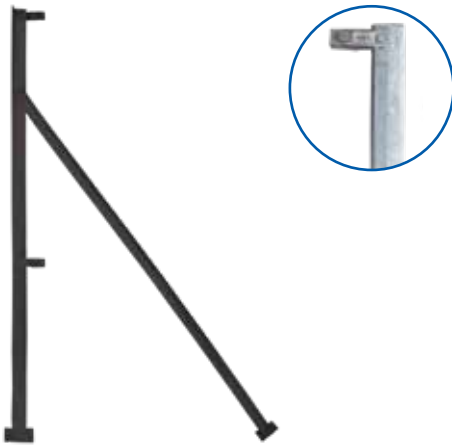

Fence Height m	Post Height m	Galvanised Code	PPC Black Code
0.90	1.50	57020209	57020209B
1.20	1.80	57020212	57020212B
1.80	2.60	57020218	57020218B
2.40	3.20	57020224	57020224B

Posts 50 x 50 x 6mm. Supplied with stretcher bar and fixings. PPC black RAL 9005.

Intermediate Post

Concrete-in



Fence Height m	Post Height m	Galvanised Code	PPC Black Code
0.90	1.50	57020109	57020109B
1.20	1.80	57020112	57020112B
1.80	2.60	57020118	57020118B
2.40	3.20	57020124	57020124B

Posts 40 x 40 x 5mm. PPC black RAL 9005.

Corner Post

Concrete-in



Fence Height m	Post Height m	Galvanised Code	PPC Black Code
0.90	1.50	57020309	57020309B
1.20	1.80	57020312	57020312B
1.80	2.60	57020318	57020318B
2.40	3.20	57020324	57020324B

Posts 50 x 50 x 6mm. Supplied with stretcher bar and fixings. PPC black RAL 9005.

Stretcher Bar



Fence Height m	Code
0.90	0702016
1.20	0702017
1.80	0702018
2.40	0702019

Fixing holes 20 x 5mm.

Tamper Drive

Universal Security Fastener



Features

- Self-drilling
- Vandal resistant low profile head
- Rapid installation
- Excellent for use with Mesh-Loc

Tool Bit

Length mm	Code
74	080221

Tool bit to suit a standard drill. Zinc plated.

Countersunk Screw Head

Ø x Length mm	Code
M5.5 x 25	09FA527
M5.5 x 38	09FA528

Zinc plated.



Stock fencing is used largely in agricultural farming. Supplied galvanised or Rylock Green, which have both been designed to provide assurance of quality and longevity. Available in 4 types:

Medium - A medium gauge stock fence used for all types of permanent fencing of life stock.

Vulcan - A Vanadium enhanced high tensile stock fence for ultimate strength and pliability, allows greater tensioning and a higher resistance to impact than other steel types.

Galvanised

Type	Style	Roll Height m	Roll m	No. of Horizontal Wires	Distance Between Vertical Wires mm	Code
Medium	C8/80/15	0.80	50	8	150	09C8801550GLV
Vulcan	HT8/80/15	0.80	100	8	150	09VHT88015100GLV



Rylock Green

Type	Style	Roll Height m	Roll m	No. of Horizontal Wires	Distance Between Vertical Wires mm	Code
Medium	C8/80/15	0.80	50	8	150	09C8801550GRN
Vulcan	HT5/53/15	0.53	100	5	150	09VHT55315100GRN
Vulcan	HT8/80/15	0.80	100	8	150	09VHT88015100GRN



Staples

Size mm	Pack kg	Code
40 x 4	10	09S4010
40 x 4	20	09S4020



For stretcher bar see page 645.

Applications

- Heavily galvanised fencing staples to hold fencing firmly in place



You can order online 24 hours a day, 7 days a week, visit our website: www.fhbrundle.co.uk



Welded wire mesh security fencing rolls are one of the most comprehensive and widely used ranges of fencing products, designed to cover the broadest spectrum of applications in almost every category of the modern fencing market.

Pre-Galvanised 50 x 50mm Security Fencing



Fence Height m	Roll m	Wire Ø mm	Code
0.9	25.0	2.5	4602095025
0.9	25.0	3.0	460209503
1.2	25.0	2.5	4602125025
1.2	25.0	3.0	460212503
1.5	25.0	3.0	460215503
1.8	25.0	2.5	4602185025
1.8	25.0	3.0	460218503
2.1	25.0	3.0	460221503
2.4	25.0	3.0	460224503

Mesh size 50 x 50mm.

Pre-Galvanised 75 x 25mm Security Fencing



Fence Height m	Roll m	Wire Ø mm	Code
1.2	25.0	3.0	460212753
1.8	25.0	3.0	460218753
2.4	12.5	3.0	460224753125

Mesh size 75 x 25mm.

For line wires & strainers, please see from page 644.

PVC Green 50 x 50mm Security Fencing



Fence Height m	Roll m	Wire Ø mm	Code
0.9	25.0	3.0	461509503530
1.2	25.0	3.0	461512503530
1.8	25.0	3.0	461518503530
2.4	25.0	3.0	461524503530

Mesh size 50 x 50mm.

For ball court fencing systems, call your local branch!

Barrier Fencing

The highly visible appearance together with the ease of installation makes this product ideal for use as a temporary safety warning fence around construction sites and building projects. This fencing system is rot proof, UV stabilised and chemical resistant. Easily installed using fencing pin bars, it can be easily re-rolled and transported for further use.

Orange Barrier

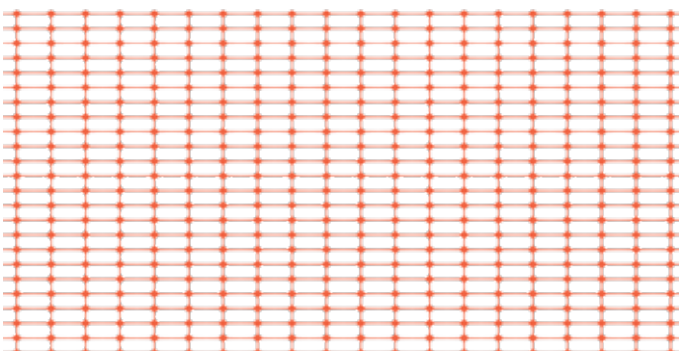

Height m	Length m	Mesh mm	Code
1	50	120 x 30	080661

High density polyethylene.

Fencing Pin Bar

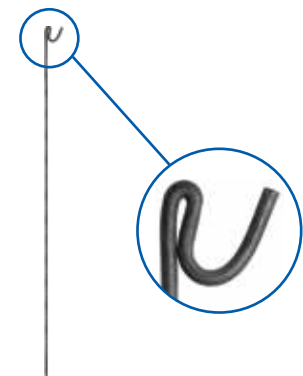

Height m	Ø m	Code
1.2	10	080675

Use every 2 - 3m.

Steel
Wrought Iron Components
Gate Hardware
Sliding Door Gear
Gate Automation
Mesh
Decking & Subframe
Flooring & Stair Treads
Handrailing
Fencing
Fixings

Clipping Gun



Applications

- Can be used for tree guards & silt fence
- Bird control & tagging
- Fruit & rabbit netting applications

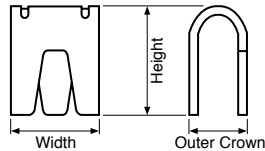

Tool

Length mm	Width mm	Depth mm	Code
660	510	30	09FA536

Clips

Pack Qty	Height mm	Width mm	Outer Crown mm	Gauge mm	Code
1224	19	17	9	0.8	0111

Stainless steel Grade 430.

Alloy Pliers



Applications

- Can be used for tree guards & silt fence
- Bird control & tagging
- Fruit & rabbit netting applications

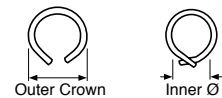

Tool

Length mm	Width mm	Depth mm	Code
180	56	13	0702003

Clips

Pack Qty	Outer Crown mm	Inner mm	Code
100	19	13	0702002*
100	19	15	080611*
200	19	13	0702001**

*Heavy sheradised. **BZP.

Manual Fencing Ring Pliers & Clips

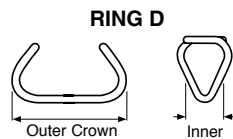

Applications

- Attaching line wires to chain link fencing

Tool

Length mm	Width mm	Depth mm	Code
195	105	23	09FA510

50 hog rings per central magazine.

Clips

Pack Qty	Ring	Outer Crown mm	Inner mm	Code
1000	D	22	7	09FA03

Rapid Fencing Pliers 7 Clips

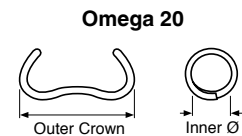

Applications

- Ideal for thicker wire netting & chain link
- Assembling bird & animal cages
- Most wire fencing construction

Features

- Quick-load mechanism for easy reloading
- Designed for heavy duty hog rings
- Ergonomic soft handle with lock

Tool

Length mm	Width mm	Depth mm	Code
160	120	20	0702222

30 hog rings per magazine.

Clips

Pack Qty	Outer Crown mm	Inner Ø mm	Code
1100	20	5	07021100
1600	20	5	09FA07
1600	20	5	09FA08*

*PVC green.



Offering strength and stability, this heavy duty system is manufactured from galvanised steel. Completely reusable, these panels and gates can be used in a number of applications, such as construction sites and outdoor locations.

Mesh Fence Panel - Square Top

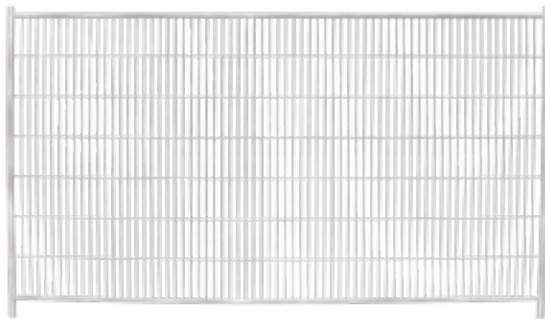

H x W mm	Mesh mm	Gaugemm	Code
2025 x 3460	262 x 43	2.2	080671

Horizontal tubes are Ø 25.4mm. Vertical tubes are Ø 38.1mm.

Mesh Fence Panel - Round Top

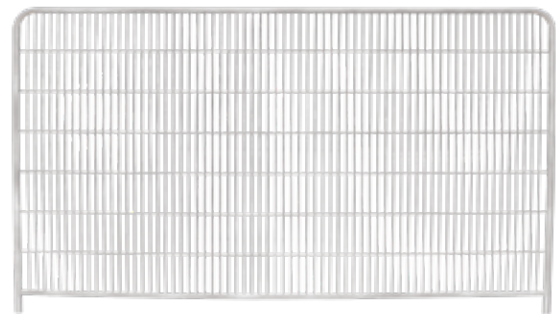

H x W mm	Mesh mm	Gauge mm	Code
2000 x 3450	262 x 43	2.2	080683

Horizontal tubes are Ø 25.4mm. Vertical tubes are Ø 38.1mm.

Standard Coupler



Code
080669

Thermoplastic Foot

For anti-climb temporary fence panels



Weight kg	Code
25	080673

Supplied in black.

Vehicle Gate - Round Top

With mesh infill

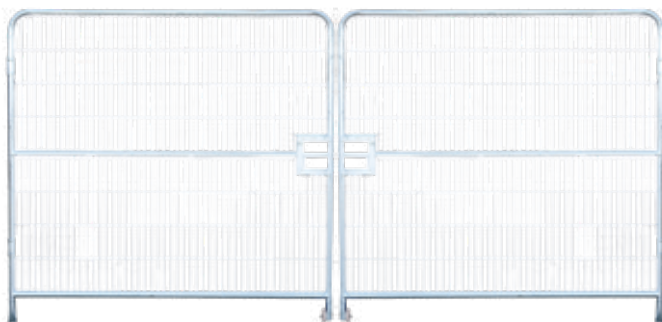

H x W mm	Mesh mm	Gauge mm	Code
2000 x 4200	262 x 43	2.2	080682

Horizontal tubes are Ø 25.4mm. Vertical tubes are Ø 38.1mm. Supplied with 2 wheels. Allows wide vehicles on site.

Pedestrian Gate

With mesh infill



H x W mm	Mesh mm	Gauge mm	Code
2000 x 1059	262 x 43	2.2	080672

Horizontal tubes are Ø 25.4mm. Vertical tubes are Ø 38.1mm. Supplied with 1 wheel.

Temporary Fencing



Steel

Gate Lock



Code
080680

Vandal proof. For use with code: **53099**.

Padlock



Code
53099

Supplied with 2 keys. For use with code: **080680**.

Castor Wheel



Size mm	Code
110 x 345 x 100	080681

Supplied as a single wheel. Can be used to convert a standard panel to a gate.

Wrought Iron Components

Stability Brace



Height mm	Code
1485	080674

Can be used with soil pin code: **080677**, sand bags and/or ballast blocks. Fix to fence panels using a standard coupler code: **080669**.

Soil Pin



Height mm	Width mm	Code
438	88	080677

Steadfast Strut



Size mm	Code
780	080676

For use with thermoplastic foot code: **080673**. Fix to fence panels using a standard coupler code: **080669**.

Gate Hardware

Sliding Door Gear

Gate Automation

Mesh

Anti-lift Strip



Code
080679

For use with thermoplastic foot code: **080673**.

Barbed Wire Extension Bracket



Height mm	Code
535	080678

For extending panel to 2m high and use of barbed wire. Fix to fence panels using a standard coupler code: **080669**.

Debris Netting



Colour	Height m	Length m	Code
Green	2	50	080663

Decking & Subframe

Flooring & Stair Treads

Handrailing

Fencing

Fixings





Site gates are a secure and cost effective solution for building site security. The functional design keeps the cost low while maintaining a high standard of protection. All of our site gates are galvanised in order to protect them from corrosion and can be clad with a standard 2.44 x 1.22m (8' x 4') mesh or hoarding timber as required, meaning they can be de-constructed and re-used on multiple sites.

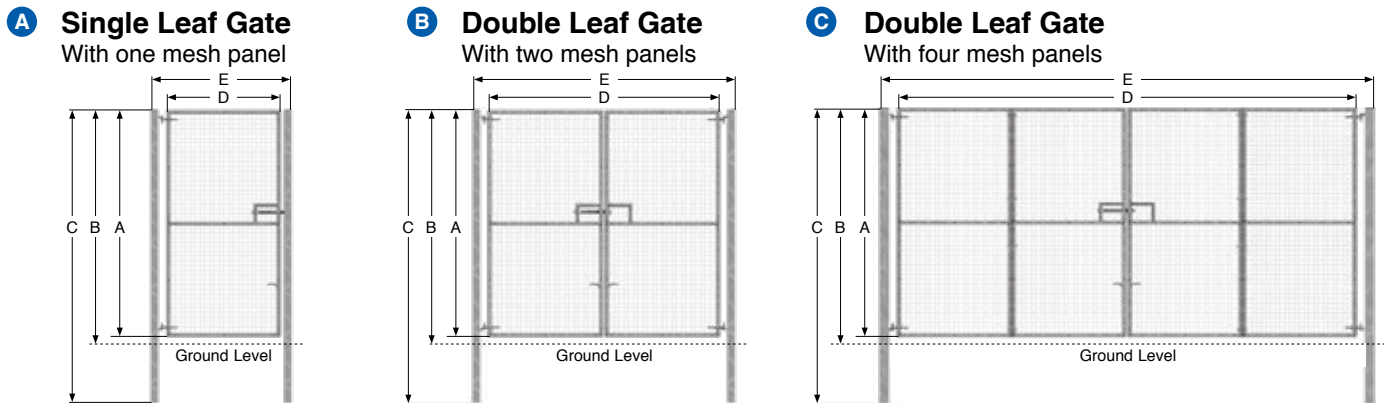

Gate	(A) m	(B) m	(C) m	(D) m	(E) m	Gate Post □ mm	Code
A	2.44	2.50	3.15	1.22	1.51	80	54SLSG2412K
B	2.44	2.50	3.15	2.46	2.78	80	54DLSG2424K
C	2.44	2.50	3.15	4.90	5.28	100	54DLSG2448K

Our site gates require assembling and are supplied as frame, posts, 8' x 4' sheets, 2" x 2" mesh 10g, stretcher bars, hinges, Ø 20mm drop bars and Tek screws to fix bars and mesh to gate frames.



Example clad with mesh.



Example clad with wood.

For Gates Without Mesh - To Be Clad In Ply Or Other Materials. Please Use The Table Below

Description	Gate Frame Code	5.5 x 38mm TEK Screws (Qty 100) Code
Single Leaf Gate Posts and Frame (1 panel)	54SLSG2412	5002TEK55538
Double Leaf Gate Posts and Frame (2 panels)	54DLSG2424	5002TEK55538
Double Leaf Gate Posts and Frame (4 panels)	54DLSG2448	5002TEK55538

Our site gates are self-assemble. Ply and other materials are not supplied

Clamp Bar Kit

Pack of 7



Length m	Code
1.15	54CBS12

See our full range of crash barrier from page 694.

See our full range of bollards & site protection from page 699.

Steel

Wrought Iron Components

Gate Hardware

Sliding Door Gear

Gate Automation

Mesh

Decking & Subframe

Flooring & Stair Treads

Handrailing

Fencing

Fixings



3m wide panel featuring horizontal reinforcements. All components have been specifically developed to provide a professional product of high quality that can be installed quickly and efficiently.

The construction style means 20% less posts are required, 20% less concrete and a 20% reduction in installation time, compared to our other available systems. A cost effective solution for industrial sites and long fencing runs.

Applications:

- Public buildings
- Factories
- Workshops
- Schools

Quick order calculator

1. Divide metre run required by 3.025 = number of posts (if end or corner posts required, please add).
2. Take number of posts and multiply by the number of fixings required, see table.
3. Add Trilobe Allen key to order, if required.

Specification:

- **Mesh Pattern:** 200 x 50mm resistance welded at each intersection
- **Horizontal Wires:** Ø 5mm at 200mm centres
- **Vertical Wires:** Ø 5mm at 50mm centres
- **Finish:** Powder coated green or black with galvanised substrate
- **Presentation:** All panels have a 30mm barbed top edge
- **Posts:** Twilfix® 2000 system
- **Post Centres:** At approximately 3.025m

Scan here for the installation guide.



Security

Nylofor® 3-M satisfies the requirements for Category: 1 (General purpose) and Category: 2 (Security) fences. As prescribed by BS1722 Part 14.

Coating

Panels are manufactured from pre-galvanised wires and powder coated. Posts are polyester powder coated (PPC) with a galvanised substrate in accordance with Euro norm 10147.

All polyester powder coated products are tested for adherence to 1000 hour salt spray testing according to DIN 50021 (=ASTM B 117 =ISO 9227) + DIN 53167 and conforming to EN 10223 - 7.





Price Per Metre Run

The panels are 3m wide and have vertical bars of 30mm on the top of the panel (panels are reversible if required - bars at top or at bottom). Mesh sizes are 200 x 50mm, and 100 x 50mm for the beam sections. Heavy wires, with a Ø 5mm guarantee a high level of rigidity. Metre runs include intermediate posts and clips.

Fence Height m	Panel Size H x W mm	Panel Weight kg	Number of 'V' Beams	PVC Green Metre Code	PVC Black Metre Code
1.2	1230 x 3000	13.5	2	56NY3M12GM	56NY3M12BM
1.7	1730 x 3000	18.9	3	56NY3M18GM	56NY3M18BM
2.0	1930 x 3000	22.3	3	56NY3M20GM	56NY3M20BM
2.4	2430 x 3000	25.3	4	56NY3M24GM	56NY3M24BM

Twilfix® 2000 Post System

Posts are manufactured from 60 x 60mm square hollow sections and fitted with M8 threaded inserts for securing the panels. Posts come with flat top caps. Panels are fixed using 3D profile and universal fixing brackets with M8 x 35mm countersunk Trilobe tamper proof bolts.

Fence Height m	Overall Height mm	Post Weight kg	Intermediate/End Post				Corner Post			
			No. of Fixings Required		PPC Green Code	PPC Black Code	No. of Fixings Required		Green Code	Black Code
			Unifix	3D Profile			Unifix	3D Profile		
1.2	1800	5.4	2	2	56BOX12iG	56BOX12iB	4	4	56BOX12CG	56BOX12CB
1.7	2400	7.0	3	2	56BOX17iG	56BOX17iB	6	4	56BOX17CG	56BOX17CB
2.0	2700	7.8	4	2	56BOX20iG	56BOX20iB	8	4	56BOX20CG	56BOX20CB
2.4	3100	8.9	5	2	56BOX24iG	56BOX24iB	10	4	56BOX24CG	56BOX24CB

Fixings not supplied with posts - please select your requirement below.

Fixings

Description	Colour	Each	Code
Unifix - Nylon	Green	1	56F001*
Unifix - Nylon	Black	1	56F004*
3D Profile - Nylon	Green	1	56F002*
3D Profile - Nylon	Black	1	56F005*
Trilobe Allen key	-	1	56F013



Unifix - Nylon



3D Profile - Nylon



Trilobe Allen key

Fixings include bolts. *Nylon (Polyamide).

Panels

Fence Height m	Panel Size H x W mm	Panel Weight kg	Number of 'V' Beams	PVC Green Panel Code	PVC Black Panel Code
1.2	1230 x 3000	13.5	2	56NY3M12G	56NY3M12B
1.7	1730 x 3000	18.9	3	56NY3M18G	56NY3M18B
2.0	1930 x 3000	22.3	4	56NY3M19G	56NY3M19B
2.4	2430 x 3000	25.3	4	56NY3M24G	56NY3M24B

Privacy Fencing Roll

- Privacy for residential properties, terraces & balconies
- Protection against adverse weather
- Helps reduce unwanted noise from outside the property
- UV resistant

Colour	Height mm	Length Linear m	Code
Green	190	50	54PFR190G
Black	190	50	54PFR190B



Green

Black



The ideal solution for most types of boundary and low/medium security applications, Nylofor® 3D is attractive and cost effective. The panels feature 'V' shaped beams at the top, centre and bottom edges, which not only enhance the appearance but also provide an integral support spanning between the posts. All components have been specifically developed to provide a professional product of high quality that can be installed quickly and efficiently.

Applications:

- Public buildings
- Factories
- Workshops
- Schools
- Sports grounds

Quick order calculator

1. Divide metre run required by 2.525 = number of posts (if end or corner posts required, please add).
2. Take number of posts and multiply by the number of fixings required, see table.
3. Add Trilobe Allen key to order, if required.

Specification:

- **Mesh Pattern:** 200 x 50mm resistance welded at each intersection
- **Horizontal Wires:** Ø 5mm at 200mm centres
- **Vertical Wires:** Ø 5mm at 50mm centres
- **Finish:** Polyester powder coated (PPC) green or black with galvanised substrate
- **Presentation:** All panels have a 30mm barbed top edge
- **Posts:** Twilfix® 2000 system
- **Post Centres:** At approximately 2.525m

[Scan here for the installation guide.](#)



Security

Nylofor® 3D satisfies the requirements for Category: 1 (General purpose) and Category: 2 (Security) fences. As prescribed by BS1722 Part 14.

Coating

Panels are manufactured from pre-galvanised wires. An adhesion coating is applied to allow perfect adhesion to the polyester coating. Posts are polyester powder coated with a galvanised substrate in accordance with Euro norm 10147.

All polyester powder coated products are tested for adherence to 1000 hour salt spray testing according to DIN 50021 (= ASTM B 117 = ISO 9227) + DIN 53167 and conforming to EN 10223 - 7.





Price Per Metre Run

The panels are 2.5m wide and have vertical barbs of 30mm on the top of the panel (panels are reversible if required - barbs at top or at bottom). Mesh sizes are 200 x 50mm, and 100 x 50mm for the beam sections. Heavy wires, with a Ø 5mm guarantee a high level of rigidity. Metre runs include intermediate posts and clips.

Fence Height m	Panel Size H x W mm	Panel Weight kg	Number of 'V' Beams	PPC Green Metre Code	PPC Black Metre Code
1.7	1730 x 2500	17.5	3	56NY3D18GM	56NY3D18BM
2.0	2030 x 2500	20.7	4	56NY3D20GM	56NY3D20BM
2.4	2430 x 2500	24.3	4	56NY3D24GM	56NY3D24BM

Twilfix® 2000 Post System

Posts are manufactured from 60 x 60mm square hollow sections and fitted with M8 threaded inserts for securing the panels. Posts come with flat top caps. Panels are fixed using 3D profile and universal fixing brackets with M8 x 35mm countersunk Trilobe tamper proof bolts.

Fence Height m	Overall Height mm	Post Weight kg	Intermediate/End Post				Corner Post			
			No. of Fixings Required		PPC Green Code	PPC Black Code	No. of Fixings Required		Green Code	Black Code
			Unifix	3D Profile			Unifix	3D Profile		
1.7	2400	7.0	3	2	56BOX17iG	56BOX17iB	6	4	56BOX17CG	56BOX17CB
2.0	2700	7.8	4	2	56BOX20iG	56BOX20iB	8	4	56BOX20CG	56BOX20CB
2.4	3100	8.9	5	2	56BOX24iG	56BOX24iB	10	4	56BOX24CG	56BOX24CB

Fixings not supplied with posts - please select your requirement below.

Fixings

Description	Colour	Each	Code
Unifix - Nylon	Green	1	56F001*
Unifix - Nylon	Black	1	56F004*
3D Profile - Nylon	Green	1	56F002*
3D Profile - Nylon	Black	1	56F005*
Trilobe Allen key	-	1	56F013



Fixings include bolts. *Nylon (Polyamide).

Panels

Fence Height m	Panel Size H x W mm	Panel Weight kg	Number of 'V' Beams	PPC Green Panel Code	PPC Black Panel Code
1.7	1730 x 2500	17.5	3	56NY3D18G	56NY3D18B
2.0	2030 x 2500	20.7	4	56NY3D20G	56NY3D20B
2.4	2430 x 2500	24.3	4	56NY3D24G	56NY3D24B

Privacy Fencing Roll

- Privacy for residential properties, terraces & balconies
- Protection against adverse weather
- Helps reduce unwanted noise from outside the property
- UV resistant

Colour	Height mm	Length Linear m	Code
Green	190	50	54PFR190G
Black	190	50	54PFR190B



Steel

Wrought Iron Components

Gate Hardware

Sliding Door Gear

Gate Automation

Mesh

Decking & Subframe

Flooring & Stair Treads

Handrailing

Fencing

Fixings



Heavy gauge welded wire mesh panels featuring twin horizontal wires, positioned on either side of the verticals, offering both increased rigidity and resistance to cutting. The open mesh profile is decorative in appearance and allows excellent through vision making it suitable for many applications. All components have been specifically developed to provide a professional product of high quality that can be installed quickly and efficiently.

Applications:

- Public buildings
- Factories
- Workshops
- Schools
- Sports grounds

Quick order calculator

1. Divide metre run required by 2.525 = number of posts (if end or corner posts required, please add).
2. Take number of posts and multiply by the number of fixings required, see table.
3. Add Trilobe Allen key to order, if required.

Specification:

- **Mesh Pattern:** 200 x 50mm resistance welded at each intersection
- **Horizontal Wires:** 2 x Ø 6mm at 200mm centres
- **Vertical Wires:** Ø 5mm at 50mm centres
- **Finish:** Polyester powder coated (PPC) green or black with galvanised substrate
- **Presentation:** All panels have a 30mm barbed top edge
- **Posts:** Twilfix® 2000 ststem
- **Post Centres:** At approximately 2.525m

[Scan here for the installation guide.](#)



Security

Nylofor® 2D satisfies the requirements for Category: 1 (General purpose) and Category: 2 (Security) fences. As prescribed by BS1722 Part 14.

Coating

Panels are manufactured from pre-galvanised wires. An adhesion coating is applied to allow perfect adhesion to the polyester coating. Posts are polyester powder coated with a galvanised substrate in accordance with Euro norm 10147.

All polyester powder coated products are tested for adherence to 1000 hour salt spray testing according to DIN 50021 (= ASTM B 117 = ISO 9227) + DIN 53167 and conforming to EN 10223 - 7.



Image shows installation of a privacy fencing roll.





Price Per Metre Run

The panels are manufactured from heavy welded mesh, 2.5m wide with mesh sizes of 200 x 50mm. The panels have vertical barbs of 30mm on the top of the panel (panels are reversible, if required - barbs at top or bottom). The panels are extremely rigid and secure due to the double horizontal wires positioned on either side of the verticals, panels offer increased resistance to cutting. Metre runs include intermediate posts and clips.

Fence Height m	Panel Size H x W mm	Panel Weight kg	PPC Green Metre Code	PPC Black Metre Code
1.8	1830 x 2500	21.4	56NY2D18GM	56NY2D18BM
2.0	2030 x 2500	23.6	56NY2D20GM	56NY2D20BM
2.4	2430 x 2500	28.3	56NY2D24GM	56NY2D24BM

Twilfix® 2000 Post System

Posts are manufactured from 60 x 60mm square hollow sections and fitted with M8 threaded inserts for securing the panels. Posts come with flat top caps. Panels are fixed using universal fixing brackets with M8 x 35mm countersunk Trilobe tamper proof bolts.

Fence Height m	Overall Height mm	Post Weight kg	Intermediate/End Post			Corner Post		
			No. of Fixings Required	PPC Green Code	PPC Black Code	No. of Fixings Required	Green Code	Black Code
			Unifix			Unifix		
1.8	2500	7.2	5	56BOX18iG	56BOX18iB	10	56BOX18CG	56BOX18CB
2.0	2700	7.8	6	56BOX20iG	56BOX20iB	12	56BOX20CG	56BOX20CB
2.4	3100	8.9	7	56BOX24iG	56BOX24iB	14	56BOX24CG	56BOX24CB

Fixings not supplied with posts - please select your requirement below.

Fixings

Description	Colour	Each	Code
Unifix - Nylon	Green	1	56F001*
Unifix - Nylon	Black	1	56F004*
Trilobe Allen key	-	1	56F013

Fixings include bolts. *Nylon (Polyamide).



Unifix - Nylon



Trilobe Allen key

Panels

Fence Height m	Panel Size H x W mm	Panel Weight kg	PPC Green Panel Code	PPC Black Panel Code
1.0	1030 x 2500	12.5	56NY2D10G	56NY2D10B
1.8	1830 x 2500	21.4	56NY2D18G	56NY2D18B
2.0	2030 x 2500	23.6	56NY2D20G	56NY2D20B
2.4	2430 x 2500	28.3	56NY2D24G	56NY2D24B

Privacy Fencing Roll

- Privacy for residential properties, terraces & balconies
- Protection against adverse weather
- Helps reduce unwanted noise from outside the property
- UV resistant

Colour	Height mm	Length Linear m	Code
Green	190	50	54PFR190G
Black	190	50	54PFR190B



Green

Black



Paladin® is the most popular welded wire mesh panel due to its innovative and unique appearance. It is regularly specified for a wide range of uses where an aesthetically pleasing appearance is essential. All components have been specifically developed to provide a professional product of high quality that can be installed quickly and efficiently.

Applications:

- Public spaces
- Schools
- Retail
- Factories

Quick order calculator

1. Divide metre run required by 2.975 = number of posts (if end or corner posts required, please add).
2. Take number of posts and multiply by the number of fixings required, see table.
3. Add Trilobe Allen key to order, if required.

Specification:

- **Mesh Pattern:** Varies to 50 x 50mm max, welded at each intersection
- **Horizontal Wires:** Ø 3mm at 50mm centres with additional Ø 4mm in the 'V' beams
- **Vertical Wires:** Ø 3mm at 50mm and 12.5mm centres
- **Finish:** Polyester powder coated (PPC) green or black with galvanised substrate
- **Presentation:** Panels are flush edged all round and have additional reinforcing wires at the top, bottom and beam profiles
- **Posts:** Twilfix® 2000 system
- **Post Centres:** At approximately 2.975m

Scan here for the installation guide.



Security

Paladin® Classic satisfies the requirements for Category: 1 (General purpose) and Category: 2 (Security) fences. As prescribed by BS1722 Part 14.

Coating

Panels are manufactured from pre-galvanised wires. An adhesion coating is applied to allow perfect adhesion to the polyester coating. Posts are polyester powder coated with a galvanised substrate in accordance with Euro norm 10147.

All polyester powder coated products are tested for adherence to 1000 hour salt spray testing according to DIN 50021 (= ASTM B 117 = ISO 9227) + DIN 53167 and conforming to EN 10223 - 7.





Price Per Metre Run

The panels are 3.025m wide and have pressed 'V' beams which contain additional 4mm wires to give increased strength and rigidity. Mesh sizes vary to a maximum 50 x 50mm. Metre runs include intermediate posts and clamp bars.

Fence Height m	Panel Size H x W mm	Panel Weight kg	Number of 'V' Beams	PPC Green Metre Code	PPC Black Metre Code
1.2	1240 x 3025	15.0	2	56PAL12GM	56PAL12BM
1.8	1800 x 3000	21.3	2	56PAL18GM	56PAL18BM
2.0	2000 x 3025	24.1	3	56PAL20GM	56PAL20BM
2.4	2440 x 3025	28.3	3	56PAL24GM	56PAL24BM

Twilfix® 2000 Post System

Posts are manufactured from 60 x 60mm square hollow sections and fitted with M8 threaded inserts for securing the panels. Posts come with flat top caps. Panels are fixed using 25 x 5mm flat clamp bar with M8 x 40mm button-head Trilobe tamper proof bolts.

Fence Height m	Overall Height mm	Post Weight kg	Intermediate/End Post				Corner Post			
			No. of Fixings Required		PPC Green Code	PPC Black Code	No. of Fixings Required		Green Code	Black Code
			Clamp Bar	Bolts			Clamp Bar	Bolts		
1.2	1800	5.3	1	4	56BOX12iG	56BOX12iB	2	8	56BOX12CG	56BOX12CB
1.8	2500	7.2	1	5	56BOX18iG	56BOX18iB	2	10	56BOX18CG	56BOX18CB
2.0	2700	7.8	1	6	56BOX20iG	56BOX20iB	2	12	56BOX20CG	56BOX20CB
2.4	3100	8.9	1	7	56BOX24iG	56BOX24iB	2	14	56BOX24CG	56BOX24CB

Fixings not supplied with posts - please select your requirement below.

Fixings

Fence Height m	Per Pack	PPC Green Clamp Bar Code	PPC Black Clamp Bar Code
1.2	1 clamp bar and 4 bolts	56PFK12G	56PFK12B
1.8	1 clamp bar and 5 bolts	56PFK18G	56PFK18B
2.0	1 clamp bar and 6 bolts	56PFK20G	56PFK20B
2.4	1 clamp bar and 7 bolts	56PFK24G	56PFK24B



Description	Each	Code
Trilobe Allen key	1	56F013



Panels

Fence Height m	Panel Size H x W mm	Panel Weight kg	Number of 'V' Beams	PPC Green Panel Code	PPC Black Panel Code
1.2	1240 x 3025	15.0	2	56PAL12G	56PAL12B
1.8	1800 x 3000	21.3	2	56PAL18G	56PAL18B
2.0	2000 x 3025	24.1	3	56PAL20G	56PAL20B
2.4	2440 x 3025	28.3	3	56PAL24G	56PAL24B

See our full range of mesh gates from page 644 in stock for quick delivery.

Steel

Wrought Iron Components

Gate Hardware

Sliding Door Gear

Gate Automation

Mesh

Decking & Subframe

Flooring & Stair Treads

Handrailing

Fencing

Fixings



The principle feature is the unique and “user friendly” closed beam section located along the top and bottom edge of the panel. With no sharp or raw edges, Roll Top® panels are suitable where safety is a consideration. All the components have been specifically developed to provide a professional product of high quality that can be installed quickly and efficiently.

Applications:

- Public spaces
- Schools
- Sports grounds
- Parks
- Play grounds

Quick order calculator

1. Divide metre run required by 3.025 = number of posts (if end or corner posts required, please add).
2. Take number of posts and multiply by the number of fixings required, see table.
3. Add Trilobe Allen key to order, if required.

Specification:

- **Mesh Pattern:** 150 x 50mm resistance welded at each intersection
- **Horizontal Wires:** Ø 5mm at 150mm centres
- **Vertical Wires:** Ø 5mm at 50mm centres
- **Finish:** Polyester powder coated (PPC) green or black with galvanised substrate
- **Presentation:** Panels are flush edge all round, with radiused corners to the 50mm wide beam profiles
- **Posts:** Twilfix® 2000 system
- **Post Centres:** At approximately 3.025m

Security

Roll Top® satisfies the requirements for Category: 1 (General purpose) and Category: 2 (Security) fences. As prescribed by BS1722 Part 14.

Coating

Panels are manufactured from pre-galvanised wires. An adhesion coating is applied to allow perfect adhesion to the polyester coating. Posts are polyester powder coated with a galvanised substrate in accordance with Euro norm 10147.

All polyester powder coated products are tested for adherence to 1000 hour salt spray testing according to DIN 50021 (= ASTM B 117 = ISO 9227) + DIN 53167 and conforming to EN 10223 - 7.





Price Per Metre Run

The panels are 3m wide with a maximum height range of 1.8m. To achieve fence heights in excess of 1.8m the panels are designed for multi-lift erection. i.e. one or more panels are placed above the bottom panel. The panels have a unique and “user friendly” closed beam section located along the top and bottom edge of the panel. With no sharp or raw edges, Roll Top panels are suitable where safety is a consideration. Mesh sizes are 150 x 50mm, and panels are manufactured from heavy 5mm wires, to achieve highly rigid panels. Metre runs include intermediate posts and clips.

Fence Height m	Panel Size H x W mm	Panel Weight kg	Number of Curves	PPC Green Metre Code	PPC Black Metre Code
0.9	900 x 3000	15.6	2	56RT09GM	56RT09BM
1.2	1200 x 3000	19.6	2	56RT12GM	56RT12BM
1.5	1500 x 3000	22.8	2	56RT15GM	56RT15BM
1.8	1800 x 3000	25.2	2	56RT18GM	56RT18BM

Twilfix® 2000 Post System

Posts are manufactured from 60 x 60mm square hollow section, and fitted with M8 threaded inserts for securing the panels. Posts come with flat top caps. Panels are fixed using universal fixing brackets with M8 x 35mm countersunk Trilobe tamper proof bolts.

Fence Height m	Overall Height mm	Post Weight kg	Intermediate/End Post			Corner Post		
			No. of Fixings Required	PPC Green Code	PPC Black Code	No. of Fixings Required	Green Code	Black Code
0.9	1500	4.5	3	56BOX09iG	56BOX09iB	6	56BOX09CG	56BOX09CB
1.2	1800	5.3	4	56BOX12iG	56BOX12iB	8	56BOX12CG	56BOX12CB
1.5	2100	6.8	4	56BOX15iG	56BOX15iB	8	56BOX15CG	56BOX15CB
1.8	2500	7.2	5	56BOX18iG	56BOX18iB	10	56BOX18CG	56BOX18CB

Fixings not supplied with posts - please select your requirement below.

Roll Top® can be supplied 2.4m high, by using a 2.4m Twilfix Post code: **56BOX24iG** and **56BOX24CG** and 2 x 1.2m high panels. Join panels using the Clamp Washers code: **56F010**.

Fixings

Description	Colour	Each	Code
Unifix - Nylon	Green	1	56F001*
Unifix - Nylon	Black	1	56F004*
Clamp washers for multi-lift	Black	1	56F010
Trilobe Allen key	-	1	56F013

Fixings include bolts. *Nylon (Polyamide).



Clamp Washers



Unifix - Nylon



Trilobe Allen key

Panels

Fence Height m	Panel Size H x W mm	Panel Weight kg	Number of Curves	PPC Green Panel Code	PPC Black Panel Code
0.9	900 x 3000	15.6	2	56RT09G	56RT09B
1.2	1200 x 3000	19.6	2	56RT12G	56RT12B
1.5	1500 x 3000	22.8	2	56RT15G	56RT15B
1.8	1800 x 3000	25.2	2	56RT18G	56RT18B

Steel
Wrought Iron Components
Gate Hardware
Sliding Door Gear
Gate Automation
Mesh
Decking & Subframe
Flooring & Stair Treads
Handrailing
Fencing
Fixings



Bekafix® posts provide a discrete fixing system. With no brackets or clamp bars on the front or back of the post they provide a smooth safe finish. Ideal for all fence panels of low to medium security applications; Nylofor®, Paladin® and Roll Top.

Features:

- Virtually invisible fixing system with attractive symmetrical shaped post
- Punched holes for positioning and fixing panels with fixing clips
- Panels can be stepped down slopes in 2.5cm increments
- Cap with hook to support panels during installation
- Galvanised & polyester powder coated green RAL 6005 or black RAL 9005
- Corner post can be used to provide a change in fence direction from 90 - 180° (with the exception of Nylofor 2D)

Posts

For use with Nylofor 3D, Roll Top and Paladin



Post profile
70 x 44mm

To Suit Fence Height m	Mid / Corner Post		End Post	
	PPC Green Code	PPC Black Code	PPC Green Code	PPC Black Code
1.7	56BEK17iG	56BEK17iB	56BEK17EG	56BEK17EB
1.8	56BEK18iG	56BEK18iB	56BEK18EG	56BEK18EB
2.0	56BEK20iG	56BEK20iB	56BEK20EG	56BEK20EB
2.4	56BEK24iG	56BEK24iB	56BEK24EG	56BEK24EB

Supplied with post and mesh clips. Fixing tool required to locate and fix mesh clips into post. End posts are supplied with 2 x security bolts. For added security on mid / corner posts, order additional security bolts, if required.

Posts

For use with Nylofor 2D only



Post profile
70 x 44mm

To Suit Fence Height m	Mid / Corner Post		End Post	
	PPC Green Code	PPC Black Code	PPC Green Code	PPC Black Code
1.7	56BEK2D17iG	56BEK2D17iB	56BEK2D17EG	56BEK2D17EB
1.8	56BEK2D18iG	56BEK2D18iB	56BEK2D18EG	56BEK2D18EB
2.0	56BEK2D20iG	56BEK2D20iB	56BEK2D20EG	56BEK2D20EB
2.4	56BEK2D24iG	56BEK2D24iB	56BEK2D24EG	56BEK2D24EB

Supplied with post and mesh clips. Fixing tool required to locate and fix mesh clips into post. End posts are supplied with 2 x security bolts. For added security on mid / corner posts, order additional security bolts, if required.

Posts are suitable for base fixing when using the bolt on base plate below, but will need to be cut to required height on site.

Cranked Arm



Code
56BEKCAK

Supplied with 4 x M6 x 50mm bolts.

Base Plate



PPC Green Code	PPC Black Code
56BEKBPGK	56BEKBPBK

Supplied with 2 x M6 x 50mm bolts.

Security Bolt

M6 x 50mm



Code
56FB650

For use with mid post and clips to provide extra security when required. 2 required per post.

Fixing Tool



Code
56BEKFT

For fixing clips into the post and locking the mesh into place.



Steel

Wrought Iron Components

Gate Hardware

Sliding Door Gear

Gate Automation

Mesh

Decking & Subframe

Flooring & Stair Treads

Handrailing

Fencing

Fixings

Specification:

- Galvanised & polyester powder coated green or black
- Gates open inwards & outwards 100°
- Heavy gauge 656 weldmesh infill
- Concrete-in gate posts
- Nominal ground clearance 50mm
- Adjustable gate eyes, weld-on hooks & lugs
- Slide latch with padlock holes
- Drop bars

Single Leaf 1m Gate & Posts

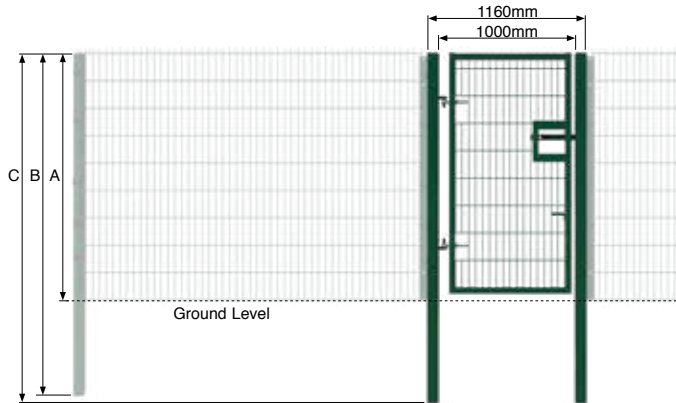

Fence Height (A) m	Panel Height mm	(B) mm	(C) mm	PPC Green Code	PPC Black Code
1.8	1836	2500	2550	54SLC181G	54SLC181B
2.0	2036	2700	2750	54SLC201G	54SLC201B
2.4	2436	3100	3150	54SLC241G	54SLC241B

Illustrations showing a left hung hinge, front facing gate. Gate frame is 60 x 40 x 3mm and gate posts are 80 x 80mm

Single Leaf 1.2m Gate & Posts

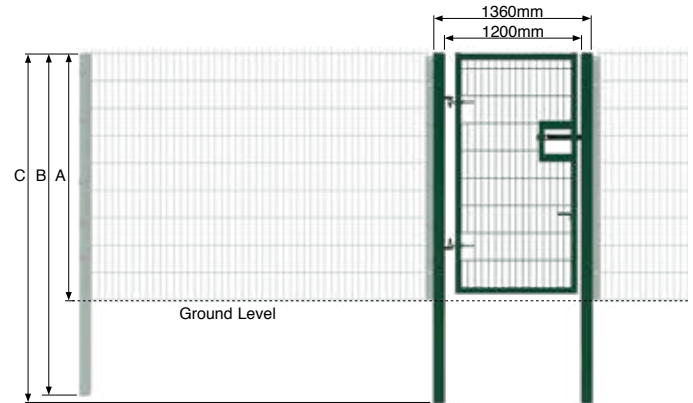

Fence Height (A) m	Panel Height mm	(B) mm	(C) mm	PPC Green Code	PPC Black Code
1.8	1836	2500	2550	54SLC1812G	54SLC1812B
2.0	2036	2700	2750	54SLC2012G	54SLC2012B
2.4	2436	3100	3150	54SLC2412G	54SLC2412B

Illustrations showing a left hung hinge, front facing gate. Gate frame is 60 x 40 x 3mm and gate posts are 80 x 80mm

Double Leaf Gate & Posts

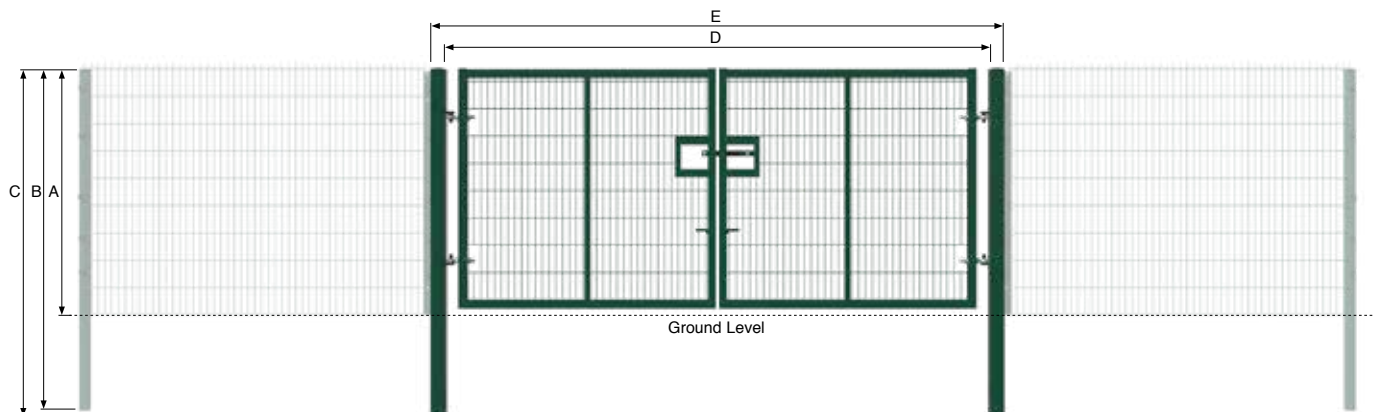

Fence Height (A) m	Panel Height mm	Gate Frame H x W x T mm	Gate Posts □ mm	(B) mm	(C) mm	(D) mm	(E) mm	PPC Green Code	PPC Black Code
1.8	1836	60 x 60 x 4	100	2500	2550	4000	4240	54DLC184G	54DLC184B
2.0	2036	60 x 60 x 4	120	2700	2750	4000	4240	54DLC204G	54DLC204B
2.4	2436	60 x 60 x 4	120	3100	3150	4000	4240	54DLC244G	54DLC244B

Illustrations showing an in-line hung, front facing gate.

Meshmaster™ Gates 656



With bolt-down posts

Steel
Wrought Iron Components
Gate Hardware
Sliding Door Gear
Gate Automation
Mesh
Decking & Subframe
Flooring & Stair Treads
Handrailing
Fencing
Fixings



Specification:

- Galvanised & polyester powder coated green or black
- Gates open inwards & outwards 100°
- Heavy gauge 656 weldmesh infill
- Bolt-down gate posts
- Nominal ground clearance 50mm
- Adjustable gate eyes, weld-on hooks & lugs
- Slide latch with padlock holes
- Drop bars

Single Leaf 1m Gate & Posts

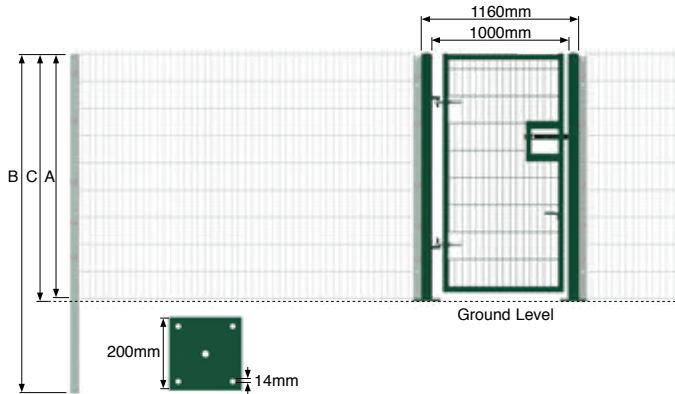

Fence Height (A) m	Panel Height mm	(B) mm	(C) mm	PPC Green Code	PPC Black Code
1.8	1836	2500	1812	54SLB181G	54SLB181B
2.0	2036	2700	2012	54SLB201G	54SLB201B
2.4	2436	3100	2412	54SLB241G	54SLB241B

Illustrations showing a left hung hinge, front facing gate. Gate frame is 60 x 40 x 3mm and gate posts are 80 x 80mm

Single Leaf 1.2m Gate & Posts

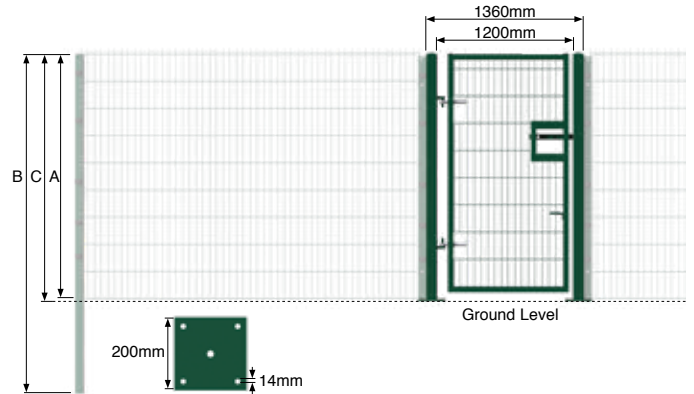

Fence Height (A) m	Panel Height mm	(B) mm	(C) mm	PPC Green Code	PPC Black Code
1.8	1836	2500	1812	54SLB1812G	54SLB1812B
2.0	2036	2700	2012	54SLB2012G	54SLB2012B
2.4	2436	3100	2412	54SLB2412G	54SLB2412B

Illustrations showing a left hung hinge, front facing gate. Gate frame is 60 x 40 x 3mm and gate posts are 80 x 80mm

Double Leaf Gate & Posts

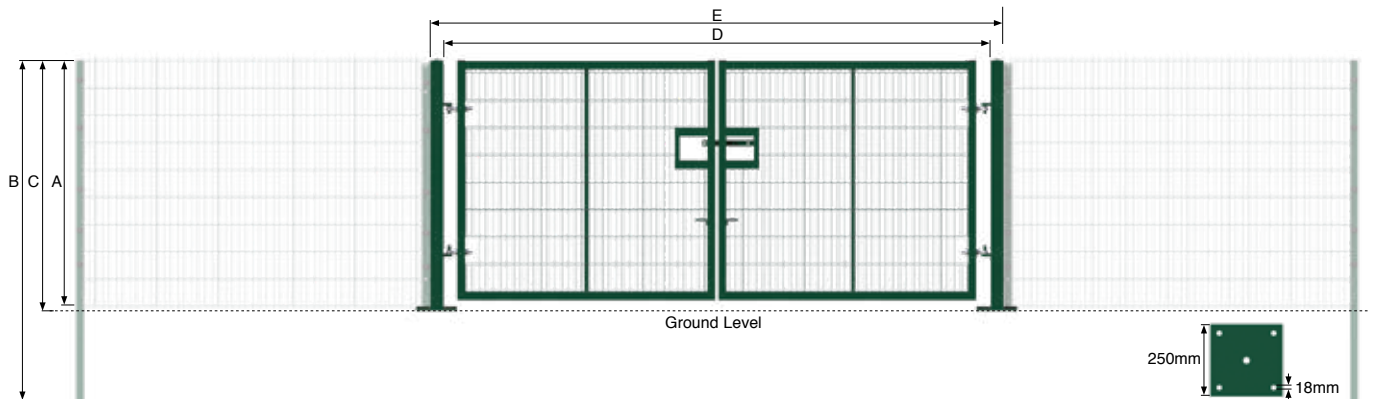

Fence Height (A) m	Panel Height mm	Gate Frame mm	Gate Posts □ mm	(B) mm	(C) mm	(D) mm	(E) mm	PPC Green Code	PPC Black Code
1.8	1836	60 x 60	100	2500	1812	4000	4240	54DLB184G	54DLB184B
2.0	2036	60 x 60	120	2700	2014	4000	4240	54DLB204G	54DLB204B
2.4	2436	60 x 60	120	3100	2114	4000	4240	54DLB244G	54DLB244B

Illustrations showing an in-line hung, front facing gate.



Featuring a toe and finger proof mesh aperture, this system combines an anti-climb and anti-cut fence with excellent through visibility and resistance to vandalism. The ultimate in discreet high security perimeter protection for schools, industrial and commercial premises. All components have been specifically developed to provide a professional product of high quality that can be installed quickly and efficiently.

Applications:

- Warehouses
- Distribution centres
- Power plants
- Laboratories
- Computer centres
- Financial institutions
- Military sites
- Prisons

Quick order calculator

1. Divide metre run required by 2.44 = number of posts (if end or corner posts required, please add).
2. Take number of posts and multiply by the number of fixings required, see table.

Specification:

- **Mesh Pattern:** 76.2 x 12.7mm resistance welded at each intersection
- **Horizontal Wires:** Ø 4mm at 12.7mm centres
- **Vertical Wires:** Ø 4mm at 76.2mm centres
- **Weld strength:** 75% of the minimum tensile strength of the wire
- **Finish:** Polyester powder coated (PPC) green or black with galvanised substrate
- **Presentation:** Overlapped 75mm minimum at each post for securing with slotted clamp bars and Ø 8mm cup square round bolts
- **Posts:** Securifor® 358 posts
- **Post Centres:** At approximately 2.44m

Security

Securifor® 358 satisfies the requirements for Category: 2 (Security), Category: 3 (High security) and Category: 4 (Maximum security) fences. As prescribed by BS1722 Part 14.

Coating

Panels are manufactured from pre-galvanised wires. An adhesion coating is applied to allow perfect adhesion to the polyester coating. Posts are polyester powder coated with a galvanised substrate in accordance with Euro norm 10147.

All polyester powder coated products are tested for adherence to 1000 hour salt spray testing according to DIN 50021 (= ASTM B 117 = ISO 9227) + DIN 53167 and conforming to EN 10223 - 7.



- Steel
- Wrought Iron Components
- Gate Hardware
- Sliding Door Gear
- Gate Automation
- Mesh
- Decking & Subframe
- Flooring & Stair Treads
- Handrailing
- Fencing
- Fixings

Securifor® 358 Maximum Security

Polyester powder coated



Panels - Metre Runs

The panels are 2.515m wide, mesh sizes are 76.2 x 12.7mm, and manufactured from 4mm wire. Weld strength is 75% of the minimum tensile strength of the wire (tensile range 540-690 N/m²). Featuring a toe and finger proof mesh aperture, this system combines an anti-climb and anti-cut fence with excellent through visibility and resistance to vandalism. Extra length panels can be supplied (+300mm) for below ground to prevent burrowing. Metre runs include intermediate posts and clamp bars.

Secured by Design



Official Police Security Initiative

Secured by Design

Securifor® 358 is a secured by design product, having passed the standards and tests which are required to achieve police preferred specifications.

Fence Height m	Panel Size H x W mm	Panel Weight kg	PPC Green Panel Code	PPC Black Panel Code
2.0	2000 x 2515	39.5	56SE35820GM	56SE35820BM
2.4	2400 x 2515	46.2	56SE35824GM	56SE35824BM
3.0	3000 x 2515	57.4	56SE35830GM	56SE35830BM

Securifor® 358 is also available 1.2 and 1.8m high.

Securifor® 358 Posts

Securifor® posts are manufactured from 60 x 60mm and 80 x 80mm square hollow section and are holed for bolt through fixing using 25 x 5mm slotted clamp bar, M8 x 100mm galvanised cup square round bolts and shear-nuts.

Fence Height m	Overall Height mm	Post Weight kg	Intermediate/End Post				Corner Post			
			No. of Fixings Required		PPC Green Code	PPC Black Code	No. of Fixings Required		PPC Green Code	PPC Black Code
			Clamp Bar	Bolts			Clamp Bar	Bolts		
2.0	2700	12.1	1	7	56SEC20iG	56SEC20iB	2	14	56SEC20CG	56SEC20CB
2.4	3100	13.9	1	9	56SEC24iG	56SEC24iB	2	18	56SEC24CG	56SEC24CB
3.0	3800	23.1	1	11	56SEC30iG	56SEC30iB	2	22	56SEC30CG	56SEC30CB

Fixings not supplied with posts - please select your requirement below.

Fixings

Fence Height m	Per Pack	PPC Green Clamp Bar Code	PPC Black Clamp Bar Code
2.0	1 clamp bar and 7 bolts	56SFK20G	56SFK20B
2.4	1 clamp bar and 9 bolts	56SFK24G	56SFK24B
3.0	1 clamp bar and 11 bolts	56SFK30G	56SFK30B



Panels

Fence Height m	Panel Size H x W mm	Panel Weight kg	PPC Green Panel Code	PPC Black Panel Code
2.0	2000 x 2515	39.5	56SE35820G	56SE35820B
2.4	2400 x 2515	46.2	56SE35824G	56SE35824B
3.0	3000 x 2515	57.4	56SE35830G	56SE35830B



For our range of crash barrier see page 694.

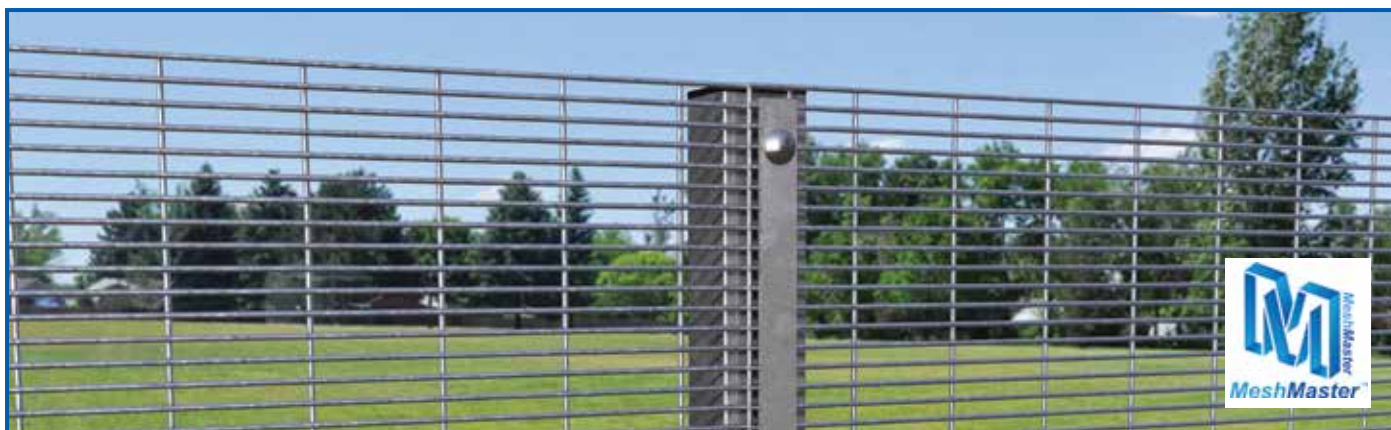

MeshMaster™ 358 is the definitive mesh fencing system for perimeter protection, featuring a finger and foothold-proof wire configuration that creates a barrier which is virtually impossible to climb, penetrate or cut by conventional means; offering maximum security and anti-corrosion protection - all backed by an expert customer service team. This system is suitable for use in many locations where security is paramount and particularly where good visibility has to be maintained, such as prisons and airports. The design of this system not only makes it the most secure within the MeshMaster™ range, it creates the most formidable perimeter solution available today.

Applications:

- Warehouses
- Distribution centres
- Power plants
- Laboratories
- Computer centres
- Financial institutions
- Military sites
- Prisons

Quick order calculator

1. Divide metre run required by 2.44 = number of posts (if end or corner posts required, please add).
Fixings supplied with posts.

Specification:

- **Mesh Pattern:** 76.2 x 12.7mm resistance welded at each intersection
- **Horizontal Wires:** Ø 4mm at 12.7mm centres
- **Vertical Wires:** Ø 4mm at 76.2mm centres
- **Weld strength:** 75% of the minimum tensile strength of the wire
- **Finish:** Galfan
- **Presentation:** Overlapped 75mm minimum at each post for securing with slotted clamp bars and Ø 8mm bolts
- **Posts:** MeshMaster™ 358 posts
- **Post Centres:** At approximately 2.44m

Security

Meshmaster™ 358 satisfies the requirements for Category: 2 (Security), Category: 3 (High security) and Category: 4 (Maximum security) fences. As prescribed by BS1722 Part 14.

Coating

Panels are manufactured from pre-galvanised wires with a Galfan finish in accordance with BS EN 10244-2:2009 Class A. Posts are galvanised to BS EN ISO 1461:2009.



Meshmaster™ 358

Galfan finish



Panels - Metre Runs

The panels are 2.515m wide, mesh sizes are 76.2 x 12.7mm, manufactured from 4mm wires and galvanised. Featuring a toe and finger proof mesh aperture, this system combines an anti-climb and anti-cut fence with excellent through visibility and resistance to vandalism. Metre runs include intermediate posts and clamp bars.

Fence Height m	Panel Size H x W mm	Panel Weight kg	Panel Code
2.1	2134 x 2515	50	540535821M
2.4	2438 x 2515	57	540535824M
3.0	2997 x 2515	70	540535830M

Meshmaster™ 358 posts

MeshMaster™ 358 posts are manufactured from 60 x 60mm and 80 x 80mm square hollow section and are holed for bolt through fixings using 40 x 6mm continuous slotted flat bar, M8 galvanised bolt and Permacone security nuts.

Fence Height m	Overall Height mm	Post Weight kg	Intermediate/End Post			Corner Post		
			No. of Fixings Required		Code	No. of Fixings Required		Code
			Clamp Bar	Bolts		Clamp Bar	Bolts	
2.1	2800	15.34	1	8	5405BOX21i	2	16	5405BOX21C
2.4	3100	16.99	1	9	5405BOX24i	2	18	5405BOX24C
3.0	4000	21.92	1	11	5405BOX30i	2	22	5405BOX30C

Clamp bar and bolts supplied with posts.

Panels

Fence Height m	Panel Size H x W mm	Panel Weight kg	Panel Code
2.1	2134 x 2515	50	540535821
2.4	2438 x 2515	57	540535824
3.0	2997 x 2515	70	540535830

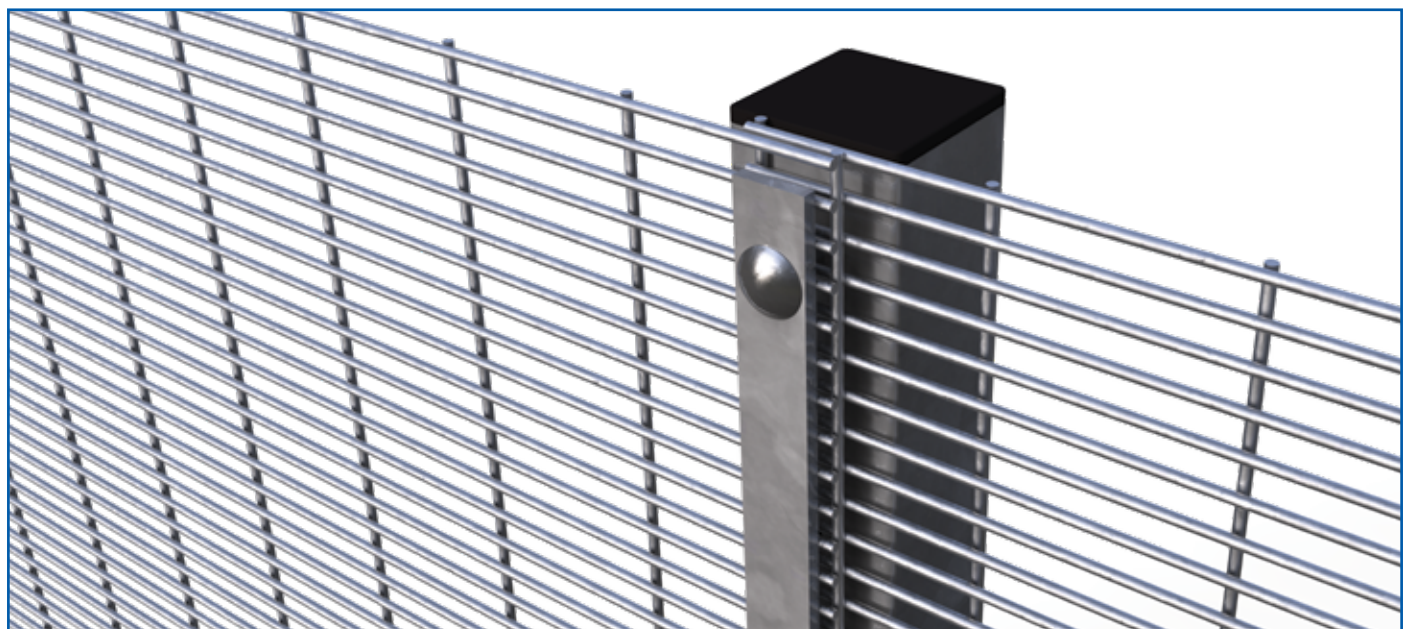



Specification:

- Galvanised & polyester powder coated green or black
- Gates open inwards 180°
- Heavy gauge 358 weldmesh infill
- Concrete-in gate posts
- Nominal ground clearance 50mm
- Adjustable gate eyes, weld-on hooks & lugs
- Slide latch with padlock holes
- Drop bars
- Mesh clamp bars
- M8 cup square bolts

Single Leaf Gate & Posts

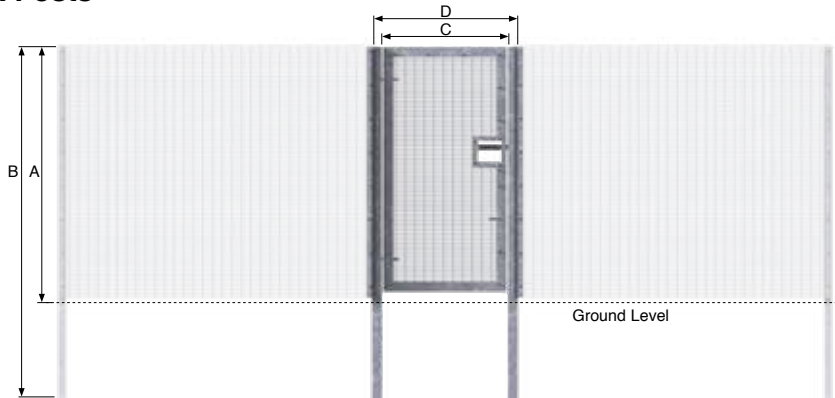

Fence Height (A) m	Panel Height mm	Gate Frame mm	Gate Posts □ mm	(B) mm	(C) mm	(D) mm	Galvanised Code	PPC Green Code	PPC Black Code
2.0	2000	80 x 40	80	2700	1036	1196	-	5404SLC201G	5404SLC201B
2.1	2134	80 x 40	80	2800	1036	1196	5404SLC211	-	-
2.4	2438	80 x 40	80	3100	1036	1196	5404SLC241	5404SLC241G	5404SLC241B
3.0	2997	80 x 40	100	4000	1036	1236	5404SLC301	5404SLC301G	5404SLC301B

Illustrations showing a left hung hinge, front facing gate.

Double Leaf Gate & Posts

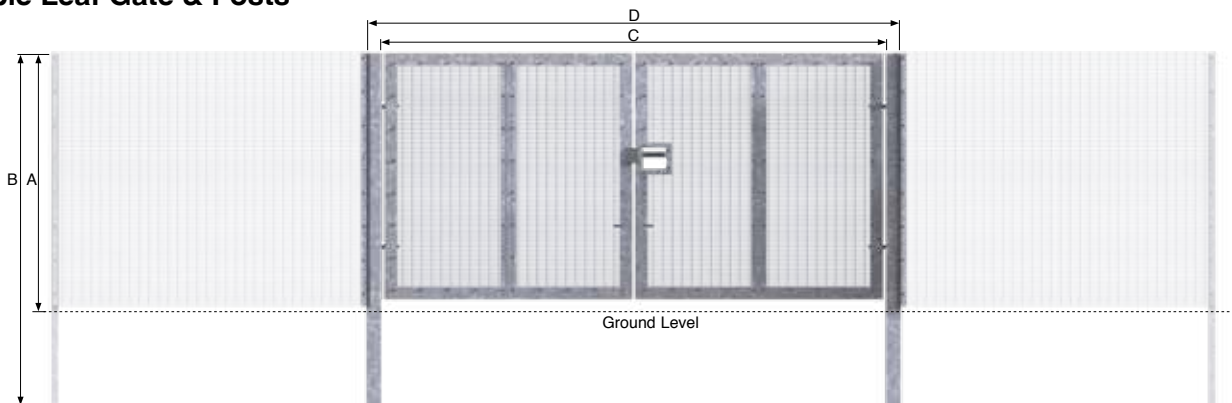

Fence Height (A) m	Panel Height mm	Gate Frame mm	Gate Posts □ mm	(B) mm	(C) mm	(D) mm	Galvanised Code	PPC Green Code	PPC Black Code
2.0	2000	80 x 40	120	2700	4000	4240	-	5404DLC204G	5404DLC204B
2.1	2134	80 x 40	120	2800	4000	4240	5404DLC214	-	-
2.4	2438	80 x 40	120	3100	4000	4240	5404DLC244	5404DLC244G	5404DLC244B
3.0	2997	80 x 40	120	4000	4000	4240	5404DLC304	5404DLC304G	5404DLC304B

Illustrations showing a rear hung, front facing gate.

Modular Mesh Fencing & Gates



Bolt-down track



On site assembly.



- Requires bolting & stitch welding on site
- Available for left or right opening gates
- Galvanised & polyester powder coated green or black

- For use where space is limited
- Ideal for use in car parks & commercial properties
- Other sizes available on request

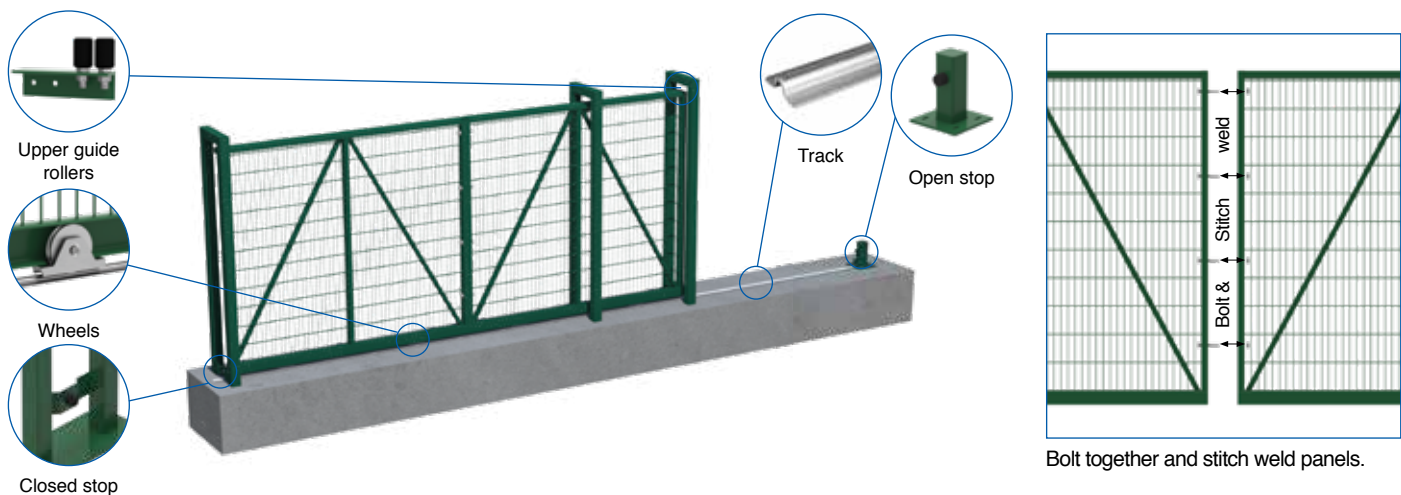

Bolt together and stitch weld panels.

4m Track Option

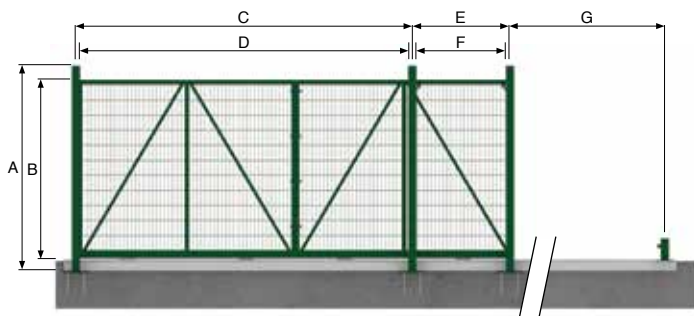

(A) mm	(B) mm	(C) mm	(D) mm	(E) mm	(F) mm	(G) mm	Right Opening Code	Left Opening Code
Black RAL 9005 Codes								
2140	1800	4100	4000	1190	1090	4150	54SGB184RB	54SGB184LB
2740	2400	4100	4000	1190	1090	4150	54SGB244RB	54SGB244LB
Green RAL 6005 Codes								
2140	1800	4100	4000	1190	1090	4150	54SGB184RG	54SGB184LG
2740	2400	4100	4000	1190	1090	4150	54SGB244RG	54SGB244LG

Kit includes 2 x gate frames, 4 x upper rollers and 4 x 3m roller track.

6m Track Option

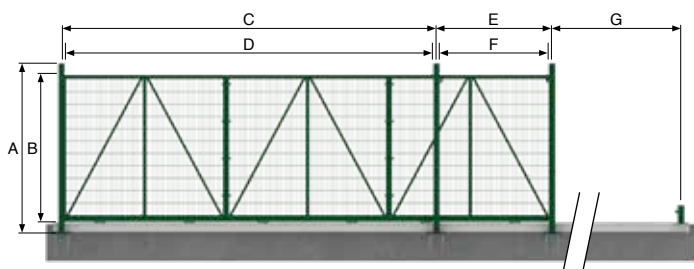

(A) mm	(B) mm	(C) mm	(D) mm	(E) mm	(F) mm	(G) mm	Right Opening Code	Left Opening Code
Black RAL 9005 Codes								
2410	1800	6100	6000	1880	1780	6115	54SGB186RB	54SGB186LB
2740	2400	6100	6000	1880	1780	6115	54SGB246RB	54SGB246LB
Green RAL 6005 Codes								
2410	1800	6100	6000	1880	1780	6115	54SGB186RG	54SGB186LG
2740	2400	6100	6000	1880	1780	6115	54SGB246RG	54SGB246LG

Kit includes 3 x gate frames 4 x upper rollers and 5 x 3m roller track.

Lock Kit

Supplied with a Locinox lock: **05LSBZ50** and keep with fixing plate and screws.



Description	Code
Lock Kit	05SGLK

If buying and fitting a lock kit, mesh needs cutting out to suit.



On site assembly.



- Requires bolting & stitch welding on site
- Available for right or left opening gates
- Galvanised & polyester powder coated green or black

- Pre-calculated concrete pad details online
- Ideal for use in car parks & commercial properties
- Other sizes available on request

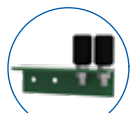

Upper guide rollers

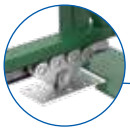

8 wheel support roller

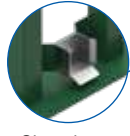

Closed stop

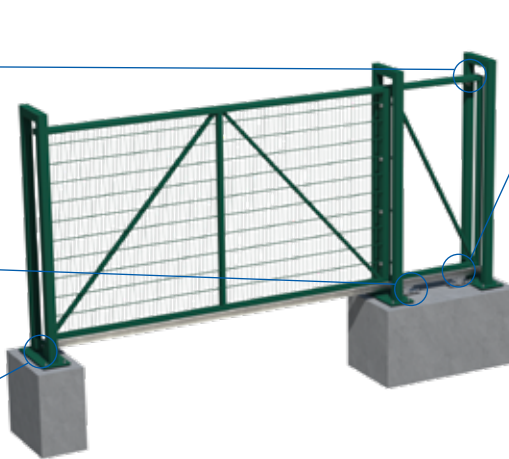

Track



Open stop

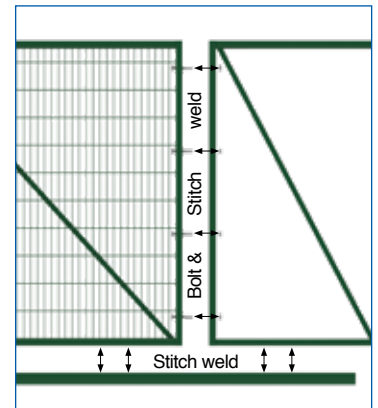

Bolt together and stitch weld panels and end frame. Frames to be welded to the cantilever track on site.

4m Cantilever Option

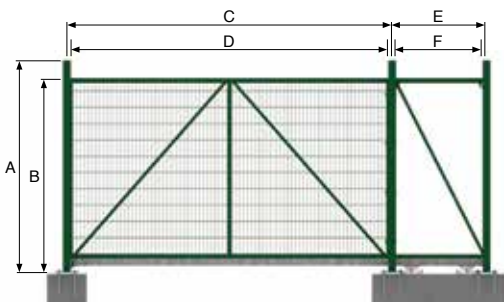

6m Cantilever Option

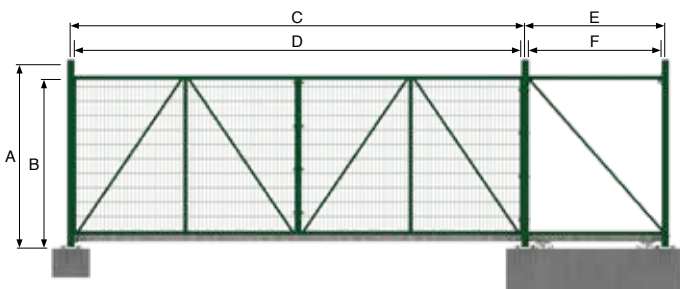

(A) mm	(B) mm	(C) mm	(D) mm	(E) mm	(F) mm	Right Opening Code	Left Opening Code
Black RAL 9005 Codes							
2000	1800	4100	4000	1180	1090	54SGC184RB	54SGC184LB
2600	2400	4100	4000	1180	1090	54SGC244RB	54SGC244LB
Green RAL 6005 Codes							
2000	1800	4100	4000	1180	1090	54SGC184RG	54SGC184LG
2600	2400	4100	4000	1180	1090	54SGC244RG	54SGC244LG

Kit includes 1 x panel, 1 x end frame, 4 x upper rollers, 2 x 8 wheel carriage blocks, 2 x guide rollers, 2 x end stops and 1 x 6m galvanised track.

(A) mm	(B) mm	(C) mm	(D) mm	(E) mm	(F) mm	Right Opening Code	Left Opening Code
Black RAL 9005 Codes							
2000	1800	6100	6000	1880	1780	54SGC186RB	54SGC186LB
2600	2400	6100	6000	1980	1880	54SGC246RB	54SGC246LB
Green RAL 6005 Codes							
2000	1800	6100	6000	1880	1780	54SGC186RG	54SGC186LG
2600	2400	6100	6000	1980	1880	54SGC246RG	54SGC246LG

Kit includes 2 x panels, 1 x end frame, 4 x upper rollers, 2 x 8 wheel carriage blocks, 2 x guide rollers, 2 x end stops, 1 x 6m galvanised track and 1 x 3m galvanised track.

Paints & Sprays

For touching up after welding frames for cantilever and track on site.



Colour	ml	Code
Green RAL 6005	400	29PC400SG
Black RAL 9005	400	29PC400SB
Zinc Galvanised Spray	500	2902A

Mesh Gates

Clamp bar kits



For more information on make your own gates, visit: www.fhbrundle.co.uk

Fence Height m	Shear Nuts Included	PPC Green Code	PPC Black Code
1.8	5	54CB18GF	54CB18BF
2.0	6	54CB20GF	54CB20BF
2.4	7	54CB24GF	54CB24BF

Kit includes 1 x clamp bar, 2 x M12 cup square bolts with shear nuts & extra shear nuts to fix mesh clips (see table above).

Please order additional mesh clips from page 673 to match the fence. The same amount of clips required as intermediate / end post.

Make Your Own Mesh Gates

If you don't see what you want from our range of stocked gates, please visit www.fhbrundle.co.uk and download our bespoke gate form. We offer a fast turnaround on made-to-order, polyester powder coated, galvanised, swing and sliding gates.

Mesh Panels For Gate Infills - Mild Steel

Fence Height m	Panel Height mm	Panel Width mm	Wire Thickness mm	Code
1.8	1830	2508	6 x 5 x 6	540165618
1.8	1830	2508	8 x 6 x 8	540186818
2.0	2030	2508	6 x 5 x 6	540165620
2.0	2030	2510	8 x 6 x 8	540186820
2.4	2430	2500	8 x 6 x 8	540186824
2.4	2430	2500	6 x 5 x 6	540165624



Reversible Latch Kits

Frame

For use with double leaf gates

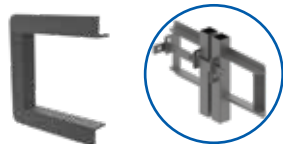

To Suit Frame □ mm	Code
40 - 50	47F40

Latch

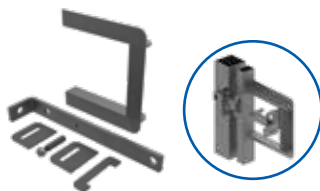

To Suit Frame □ mm	Code
40 - 50	47L40

Frame

For use with double leaf gates

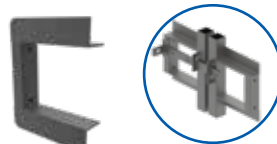

To Suit Frame □ mm	Code
60 +	47F60

Latch

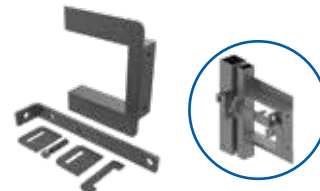

To Suit Frame □ mm	Code
60 +	47L60

Spare Handle

For Latch Kit



Code
47LH001

BZP.

Post Cap



To Suit □ mm	Code
100	3201100

Plastic.

Post Cap



To Suit □ mm	Code
100	0515057

Lug

For post to fence attachment



mm	Thickness mm	Code
60 x 30	8	05LUG6

Fixing hole 27 x 14mm.

Privacy Fencing Roll

- Privacy for residential properties, terraces & balconies
- Protection against adverse weather
- Helps reduce unwanted noise from outside the property
- UV resistant

Colour	Height mm	Length Linear m	Code
Green	190	50	54PFR190G
Black	190	50	54PFR190B



Green Black

Use with 3M, 3D XL & 2D



Unifix Nylon

- To suit any post 60mm & wider
- Includes M8 x 35mm countersunk Trilobe tamper proof bolt & washer
- Nylon (Polyamide)



Green Code	Black Code
56F001	56F004

3D Profile Nylon

- To suit any post 60mm & wider
- Includes M8 x 35mm countersunk Trilobe tamper proof bolt & washer
- Nylon (Polyamide)

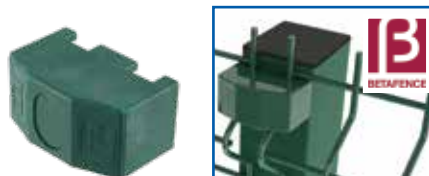

Green Code	Black Code
56F002	56F005

2D Super Nylon

- To suit any post 60mm & wider
- Includes M8 x 35mm countersunk Trilobe tamper proof bolt & washer
- Nylon (Polyamide)



Green Code	Black Code
56F003	56F006

868 Mesh

- To suit any post 50mm & wider
- Will work with rivet nuts & security fixings
- Magni 565 coated steel



Galvanised Code	Green Code	Black Code	Rubbers Code
54C009	54C010	54C011	54C019

Hole size 22 x 12mm.

868 Mesh

- To suit any post 40mm & wider
- Will work with rivet nuts & security fixings
- Magni 565 coated steel

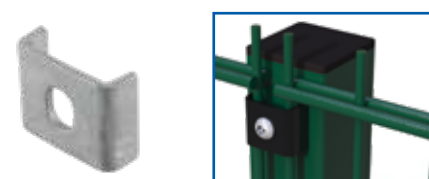

Galvanised Code	Green Code	Black Code	Rubbers Code
54C005	54C006	54C007	54C018

Hole size 14 x 10mm.

358 Mesh

- To suit any post 40mm & wider
- Will work with rivet nuts & security fixings
- Magni 565 coated steel

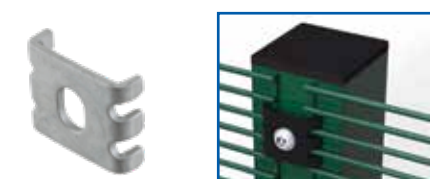

Galvanised Code	Green Code	Black Code	Rubbers Code
54C001	54C002	54C003	54C017

Hole size 14 x 10mm.

656 Mesh

- To suit any post 40mm & wider
- Will work with rivet nuts & security fixings

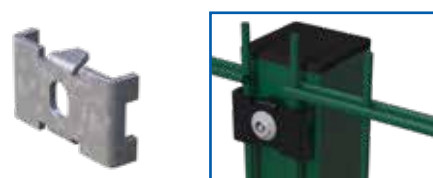

Galvanised Code	Green Code	Black Code
54C013	54C014	54C015

Hole size 14 x 10mm.

Square Clip

- To suit 60 x 60mm posts
- No threaded hole required, just Ø 12.5mm hole
- Includes aluminium M6 x 48mm nail
- Nylon (Polyamide)

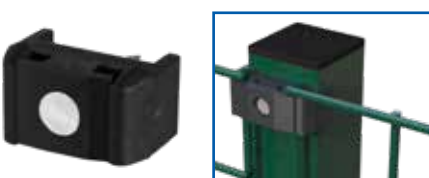

To Suit mm	Black Code
60 x 60	07024

Round Clip

- To suit Ø 48 - 60mm posts
- No threaded hole required, just Ø 12.5mm hole
- Includes aluminium M6 x 48mm nail
- Nylon (Polyamide)



Black Code
07025

Securifor 2D

- To suit any post 60mm & wider
- Includes 6 lobe high torque security screw
- Galvanised & spray coated black

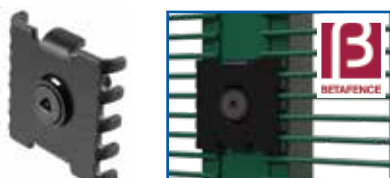

Code
56F011

Requires trilobe Allen key code: **56F013**.

Securifor 3D

- To suit any post 60mm & wider
- Includes 6 lobe high torque security screw
- Galvanised & spray coated black

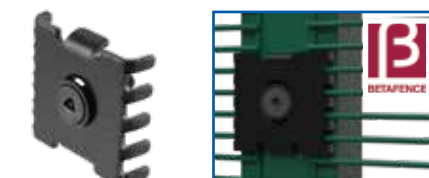

Code
56F012

Requires trilobe Allen key code: **56F013**.

Wall/Square Post Clip

- To suit any post wider than 50mm
- Great for fitting on wooden posts & walls



For Wire up to Ø mm	Holes Ø mm	Code
8 - 9	6.5	07022

Fourtress (Two Way) Vandal resistant security screw

TOOL BIT

Length mm	Code
58	09FA620

Suits a standard drill. Magni 565. Full specification can be found on page 708.

FIXINGS

Ø mm	Length mm	Code
M8	35	09FA621
M8	40	09FA622*
M8	45	09FA623
M8	50	09FA624*

Button head screw. *Machine screw. Magni 565.

Trilobe Allen Key



Code
56F013



Fastrack is a simple and effective mesh fencing system. Ideal for use in medium security applications. Easy to install and available in galvanised steel or with a polyester powder coated green RAL 6005.

Features:

- Galvanised & polyester powder coated green RAL 6005
- Hidden fixings on clamp strips for extra security
- Suitable for 1.8 & 2.4 metre fence heights
- Recommended post centres maximum 3m

Posts



Mid / End Post

To Suit Fence Height m	Post Height m	Post Size mm	Post Centres m	Galvanised Code	PPC Green Code
1.8	2.605	60 x 40 x 3	3	54EMBOX18i	54EMBOX18iG
2.4	3.215	80 x 40 x 3	3	54EMBOX24i	54EMBOX24iG

Supplied with clamp strip and fixings.

Corner Post

To Suit Fence Height m	Post Height m	Post Size mm	Post Centres m	Galvanised Code	PPC Green Code
1.8	2.605	60 x 40 x 3	3	54EMBOX18C	54EMBOX18CG
2.4	3.215	80 x 40 x 3	3	54EMBOX24C	54EMBOX24CG

Supplied with clamp strip and fixings.

Stringer Rail



Size mm	Galvanised Code	PPC Green Code
42 x 2930	54EMSR3	54EMSR3G

3 per bay required. Supplied with fixings.



Expanded Metal Panels

Ref. 4095



Mesh not to scale.

Ref. 2089



Mesh not to scale.

Galvanised

Ref. No.	Mesh Pitch mm		Open Area %	Weight Kgs/Sht	Panel H x W mm	Code
	LW	SW				
4095	101.6	50.8	81	28.61	1830 x 3050	54EM409518
4095	101.6	50.8	81	38.15	2440 x 3050	54EM409524
2089	50.8	22.58	72	40.20	1830 x 3082	54EM208918
2089	50.8	22.58	72	53.60	2440 x 3082	54EM208924

PPC Green

Ref. No.	Mesh Pitch mm		Open Area %	Weight Kgs/Sht	Panel H x W mm	Code
	LW	SW				
4095	101.6	50.8	81	28.61	1830 x 3050	54EM409518G
4095	101.6	50.8	81	38.15	2440 x 3050	54EM409524G
2089	50.8	22.58	72	40.20	1830 x 3082	54EM208918G
2089	50.8	22.58	72	53.60	2440 x 3082	54EM208924G

Latch Clamp



Galvanised Code	PPC Green Code
54EMLC	54EMLCG

For use with stringer rail. 6 per stringer required. Supplied with fixings.





Palisade fencing offers the ultimate in security. This system is easy to assemble, and once assembled offers a fencing system that is robust, long lasting and a formidable deterrent against crime and vandalism. Palisade fencing is supplied in kit form. Its design allows the fence to be erected so that it can follow the contours of the ground. Bolt-down posts for fixing to concrete can also be supplied. All steel palisade products are generally supplied hot dip galvanised to BS EN ISO 1461:2009 to give long term weather resistance. Pales can also be supplied in a plain mild steel finish or polyester powder coated to your RAL colour specification.

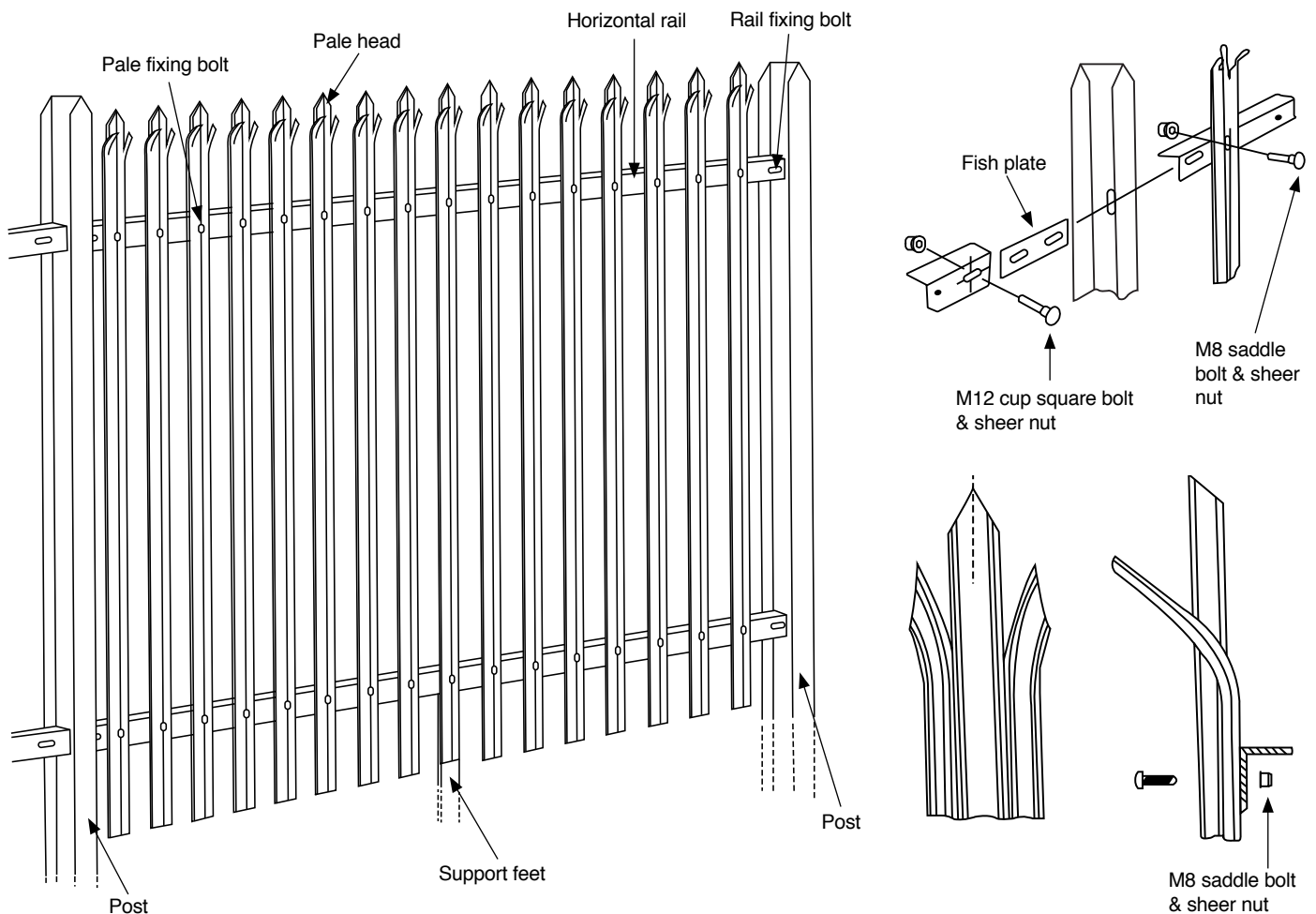

Fence Height m	Horizontal Rail mm	Post		Support Feet	
		Nominal Size mm	Centres mm	No. Per Bay	Length mm
1.8	40 x 40 x 5	97.6 x 55 x 3.6 x 4.5	2750	1	455
2.0	40 x 40 x 5	97.6 x 55 x 3.6 x 4.5	2750	1	455
2.1	45 x 45 x 6	97.6 x 55 x 3.6 x 4.5	2750	1	455
2.4	45 x 45 x 6	97.6 x 55 x 3.6 x 4.5	2750	1	610
3.0	50 x 50 x 6	97.6 x 55 x 3.6 x 4.5	2750	2	610

Metre runs

We stock triple pointed pale tops in 'D' 3mm and 'W' 2mm thickness profile sections. Our metre runs include all fixings, pales, posts and rails in galvanised finish.

Metre Runs - Bolt-Down Posts - Triple Pointed

'D' Section Pale



'W' Section Pale



Fence Height m	Code
1.8	470218BDM
2.0	470220BDM
2.1	470221BDM
2.4	470224BDM
3.0	470230BDM

3mm thick, for general purpose use. Other thicknesses available.

Fence Height m	Code
1.8	470218BWM
2.0	470220BWM
2.1	470221BWM
2.4	470224BWM
3.0	470230BWM

2mm thick, for light duty use. Other thicknesses available.

Metre Runs - Concrete-In Posts - Triple Pointed

'D' Section Pale



'W' Section Pale



Fence Height m	Code
1.8	470218CDM
2.0	470220CDM
2.1	470221CDM
2.4	470224CDM
3.0	470230CDM

3mm thick, for general purpose use. Other thicknesses available.

Fence Height m	Code
1.8	470218CWM
2.0	470220CWM
2.1	470221CWM
2.4	470224CWM
3.0	470230CWM

2mm thick, for light duty use. Other thicknesses available.

Posts

Please order an additional post to finish a complete run of palisade fencing.

Concrete-In

Fence Height m	Post Height mm	Code
1.8	2325	47040
2.0	2590	47041
2.1	2725	47042
2.4	3125	47043
3.0	3925	47044



Bolt-Down

Fence Height m	Base Plate mm	Fixing Holes Ø mm	Code
1.8	200	14	47040BP
2.0	200	14	47041BP
2.1	200	14	47042BP
2.4	200	14	47043BP
3.0	220	18	47044BP

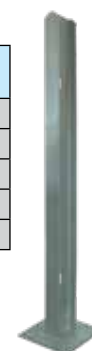

Galvanised Individual Pales

'D' Section Pale - Triple Pointed



Fence Height m	Pale Height m	Code
1.8	1.75	4702181D
2.0	1.95	4702201D
2.1	2.05	4702211D
2.4	2.35	4702241D
3.0	2.95	4702301D

3mm thick. Other thicknesses available.

'W' Section Pale - Triple Pointed



Fence Height m	Pale Height m	Code
1.8	1.75	4702181W
2.0	1.95	4702201W
2.1	2.05	4702211W
2.4	2.35	4702241W
3.0	2.95	4702301W

2mm thick. Other thicknesses available.

Rounded & Notched



Fence Height m	Pale Height m	Code
1.8	1.75	4702181RND
2.0	1.95	4702201RND
2.4	2.05	4702241RND

3mm thick. Other thicknesses available.

Mild Steel Individual Pales - Triple Pointed

'D' Section Pale



Fence Height m	Pale Height m	Code
1.8	1.75	4701181D
2.0	1.95	4701201D
2.1	2.05	4701211D
2.4	2.35	4701241D
3.0	2.95	4701301D

3mm thick. Other thicknesses available.

'W' Section Pale

Fence Height m	Pale Height m	Code
1.8	1.75	4701181W
2.0	1.95	4701201W
2.1	2.05	4701211W
2.4	2.35	4701241W
3.0	2.95	4701301W

2mm thick. Other thicknesses available.

Pales can also be supplied polyester powder coated with 100's of RAL colours to choose from.

Additional Components

Horizontal Rail



Fence Height m	W x D mm	Code
1.8 - 2.0	40 x 40	47034B
2.1 - 2.4	45 x 45	47034
3.0	50 x 50	47034A

6mm thick.

Support Foot

For use with pales



Fence Height m	Length mm	Code
1.8 - 2.1	457	47036
2.4 - 3.0	609	47036A

90° Corner Fish Plate

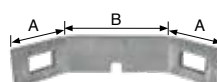

(A) mm	(B) mm	Code
50	90	47031C

6mm thick.

End Fish Plate

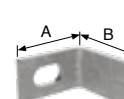

(A) mm	(B) mm	Width mm	Code
75	35	30	47031B

6mm thick.

Fish Plate



Length mm	Width mm	Code
135	30	47031

6mm thick.

Fixing Pack

Suitable For 1 Bay



Section	Code
D	47037D
W	47037W

Includes 4 x rail and 34 x pale bolts.

Saddle Bolt & Shear Nut

For fixing pales



Section	Size mm	Code
D	M8 x 40	47032D
W	M8 x 25	47032W

Cup Square Bolt & Shear Nut

For fixing horizontal rails



Ø x Length mm	Code
M12 x 30	47033

For latch kits see page 672.

Palisade Gates

With concrete-in posts



Latch pale can be cut on site to allow greater access to latch.

Specification:

- Galvanised
- Gates open inwards & outwards 100°
- Triple pointed 'D' 3mm or 'W' 2mm thick pales
- Concrete-in gate posts
- Nominal ground clearance 50mm
- Adjustable gate eyes, weld-on hooks & lugs
- Slide latch with padlock holes
- Drop bars
- M12 cup square bolts for fixing horizontal rails
- M8 saddle bolts for fixing pales

Single Leaf 1m Gate & Posts

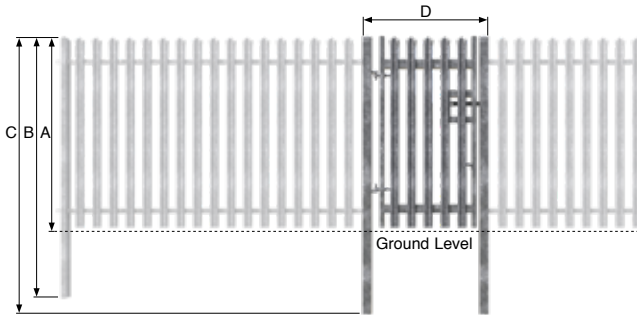

(A) m	Panel Height mm	(B) mm	(C) mm	(D) mm	'D' Code	'W' Code
1.8	1750	2400	2550	1160	47SLC181D	47SLC181W
2.0	1950	2625	2750	1160	47SLC201D	47SLC201W
2.1	2050	2725	2850	1160	47SLC211D	47SLC211W
2.4	2350	3125	3150	1160	47SLC241D	47SLC241W
3.0*	2950	3925	3750	1200	47SLC301D	47SLC301W

Illustrations showing a left hung hinge, front facing gate. Gate frame 60 x 40 x 3mm. Gate posts 80 x 80mm. *Gate posts are 100 x 100mm.

Single Leaf 1.2m Gate & Posts

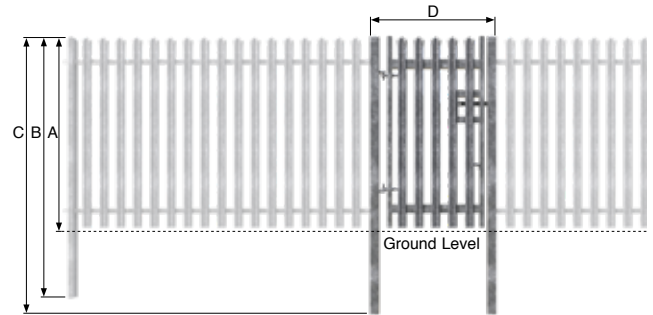

(A) m	Panel Height mm	(B) mm	(C) mm	(D) mm	'D' Code	'W' Code
1.8	1750	2400	2550	1360	47SLC1812D	47SLC1812W
2.0	1950	2625	2750	1360	47SLC2012D	47SLC2012W
2.1	2050	2725	2850	1360	47SLC2112D	47SLC2112W
2.4	2350	3125	3150	1360	47SLC2412D	47SLC2412W
3.0*	2950	3925	3750	1400	47SLC3012D	47SLC3012W

Illustrations showing a left hung hinge, front facing gate. Gate frame 60 x 40 x 3mm. Gate posts 80 x 80mm. *Gate posts are 100 x 100mm.

Double Leaf Gate & Posts

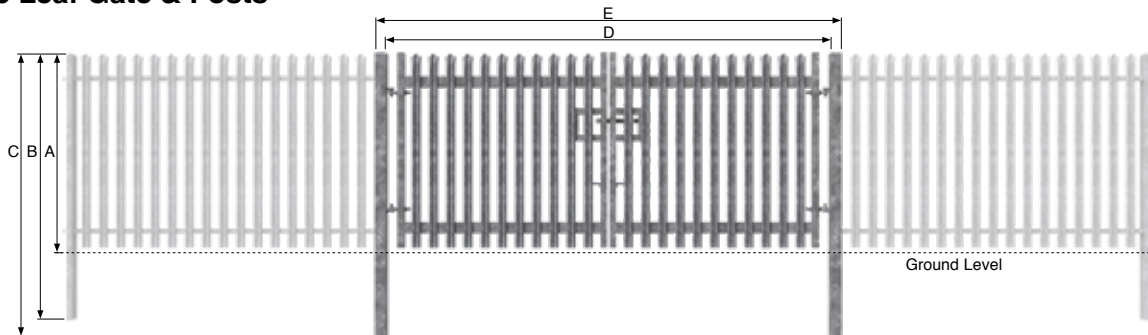

Fence Height (A) m	Panel Height mm	Gate Frame mm	Gate Posts □ mm	(B) mm	(C) mm	(D) mm	(E) mm	'D' Code	'W' Code
1.8	1750	60 x 60	100	2400	2550	4000	4200	47DLC184D	47DLC184W
2.0	1950	60 x 60	120	2625	2750	4000	4240	47DLC204D	47DLC204W
2.1	2050	60 x 60	120	2725	2850	4000	4240	47DLC214D	47DLC214W
2.4	2350	60 x 60	120	3125	3150	4000	4240	47DLC244D	47DLC244W
2.4	2350	60 x 60	120	3125	3150	6000	6300	47DLC246D	47DLC246W
3.0	2950	60 x 60	120	3925	3750	4000	4240	47DLC304D	47DLC304W

Illustrations showing an in-line hung, front facing gate.



Specification:

- Galvanised
- Gates open inwards & outwards 100°
- Triple pointed 'D' 3mm or 'W' 2mm thick pales
- Bolt-down gate posts
- Nominal ground clearance 50mm
- Adjustable gate eyes, weld-on hooks & lugs
- Slide latch with padlock holes
- Drop bars
- M12 cup square bolts for fixing horizontal rails
- M8 saddle bolts for fixing pales

Single Leaf 1m Gate & Posts

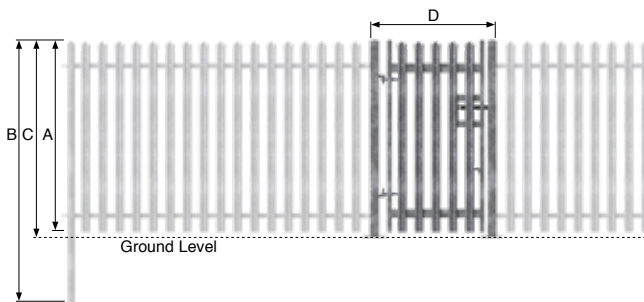

(A) m	Panel Height mm	(B) mm	(C) mm	(D) mm	(E) mm	(Ø) mm	'D' Code	'W' Code
1.8	1750	2400	1812	1160	200	14	47SLB181D	47SLB181W
2.0	1950	2625	2012	1160	200	18	47SLB201D	47SLB201W
2.1	2050	2725	2112	1160	200	18	47SLB211D	47SLB211W
2.4	2350	3125	2412	1160	200	18	47SLB241D	47SLB241W
3.0*	2950	3925	3014	1200	250	18	47SLB301D	47SLB301W

Illustrations showing a left hung hinge, front facing gate. Gate frame 60 x 40 x 3mm. Gate posts 80 x 80mm. *Gate posts are 100 x 100mm.

Single Leaf 1.2m Gate & Posts

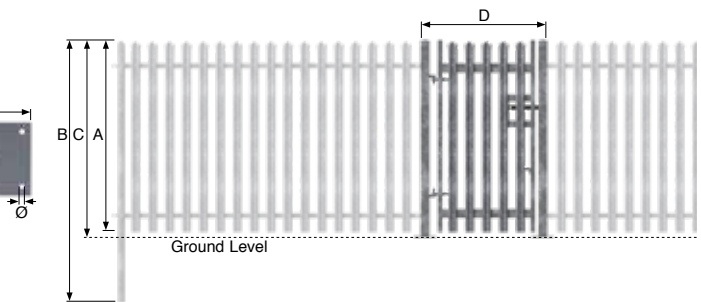

(A) m	Panel Height mm	(B) mm	(C) mm	(D) mm	(E) mm	(Ø) mm	'D' Code	'W' Code
1.8	1750	2400	1812	1360	200	14	47SLB1812D	47SLB1812W
2.0	1950	2625	2012	1360	200	18	47SLB2012D	47SLB2012W
2.1	2050	2725	2112	1360	200	18	47SLB2112D	47SLB2112W
2.4	2350	3125	2412	1360	200	18	47SLB2412D	47SLB2412W
3.0*	2950	3925	3014	1400	250	18	47SLB3012D	47SLB3012W

Illustrations showing a left hung hinge, front facing gate. Gate frame 60 x 40 x 3mm. Gate posts 80 x 80mm. *Gate posts are 100 x 100mm.

Double Leaf Gate & Posts

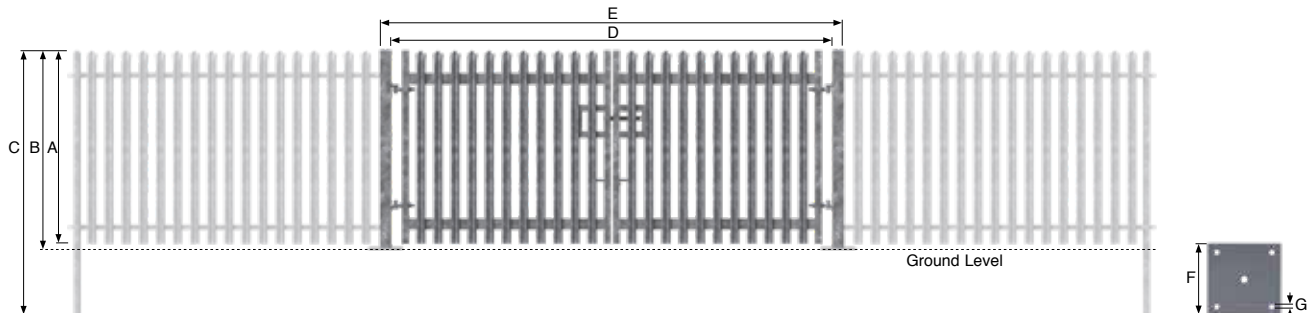

Fence Height (A) m	Panel Height mm	Gate Frame mm	Gate Posts □ mm	(B) mm	(C) mm	(D) mm	(E) mm	(F) mm	(G) Ø mm	'D' Code	'W' Code
1.8	1750	60 x 60	100	2400	1812	4000	4200	250	18	47DLB184D	47DLB184W
2.0	1950	60 x 60	120	2625	2014	4000	4240	250	18	47DLB204D	47DLB204W
2.4	2350	60 x 60	120	3125	2414	4000	4240	250	18	47DLB244D	47DLB244W
2.4	2350	60 x 60	120	3125	2414	6000	6300	250	18	47DLB246D	-
3.0	2950	60 x 60	120	3925	3014	4000	4240	250	18	47DLB304D	47DLB304W

Illustrations showing an in-line hung, front facing gate.

Modular Palisade Gate Kits



Bolt-down track

- Steel
- Wrought Iron
- Gate Hardware
- Sliding Door Gear
- Gate Automation
- Mesh
- Decking & Subframe
- Flooring & Stair Treads
- Handrailing
- Fencing
- Fixings



On site assembly.



Our 4 and 6m track gates are delivered as individual frames which require bolting and stitch welding on site. Pales are supplied individually for each gate frame. The modular design allows for easier handling and installation.

- Available for left or right opening gates
- Choose from W or D pale profile
- For use where space is limited
- Pre-calculated concrete pad details online
- Ideal for use in car parks & commercial properties
- Other sizes available on request

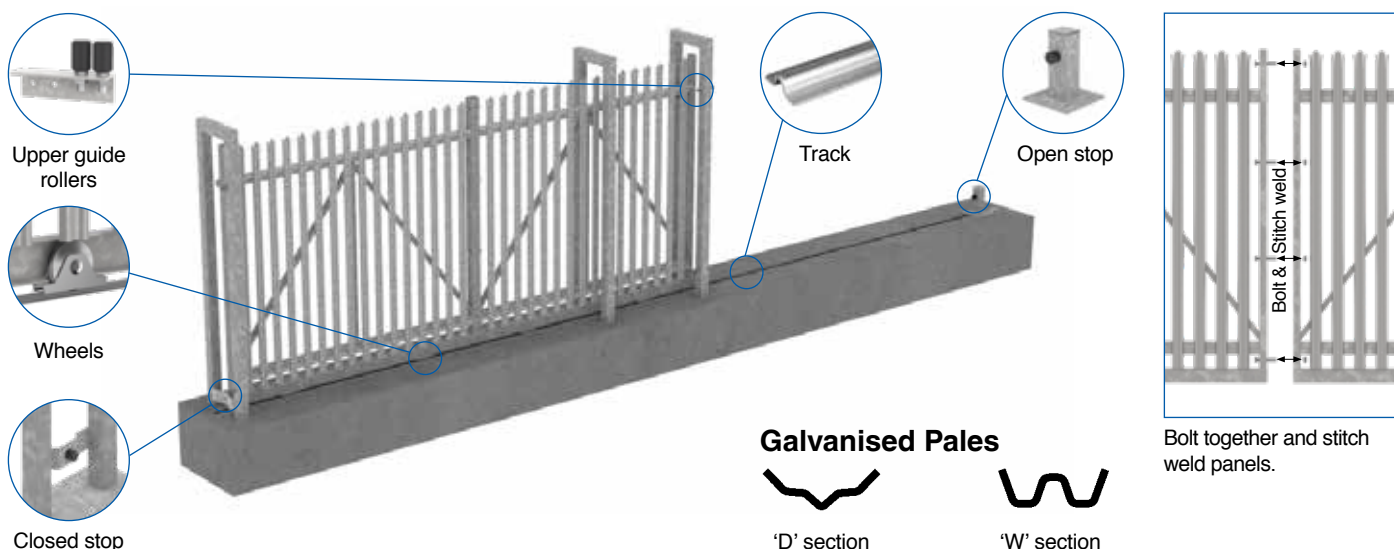

4m Track Option

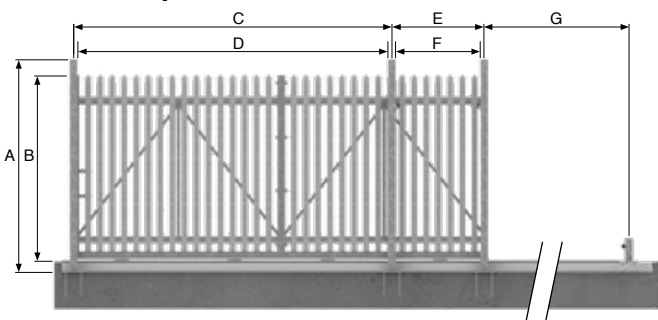

(A) mm	(B) mm	(C) mm	(D) mm	(E) mm	(F) mm	(G) mm	Right Opening Code	Left Opening Code
2140	1800	4100	4000	1190	1090	4150	47SGB184RW	47SGB184LW
2740	2400	4100	4000	1190	1090	4150	47SGB244RW	47SGB244LW
2140	1800	4100	4000	1190	1090	4150	47SGB184RD	47SGB184LD
2740	2400	4100	4000	1190	1090	4150	47SGB244RD	47SGB244LD

Kit includes 2 x gate frames, 4 x upper rollers and 4 x 3m roller track. For a lock order code: **05LSBZ50**, for keep order code: **05LSBZ** and for fixing plate order code: **47SGLPK**.

6m Track Option

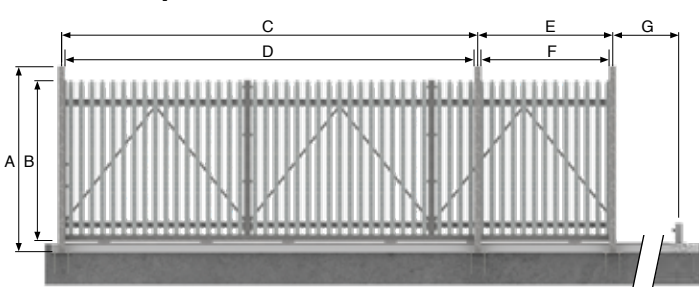

(A) mm	(B) mm	(C) mm	(D) mm	(E) mm	(F) mm	(G) mm	Right Opening Code	Left Opening Code
2410	1800	6100	6000	1880	1780	6115	47SGB186RW	47SGB186LW
2740	2400	6100	6000	1880	1780	6115	47SGB246RW	47SGB246LW
2410	1800	6100	6000	1880	1780	6115	47SGB186RD	47SGB186LD
2740	2400	6100	6000	1880	1780	6115	47SGB246RD	47SGB246LD

Kit includes 3 x gate frames 4 x upper rollers and 5 x 3m roller track. For a lock order code: **05LSBZ50**, for keep order code: **05LSBZ** and for fixing plate order code: **47SGLPK**.



Our 4 and 6m cantilever gates are delivered as individual frames which require bolting and stitch welding on site. Pales are supplied individually for each gate frame. The modular design allows for easier handling and installation.

- Available for right or left opening gates
- Choose from W or D pale profile
- For use where space is limited
- Pre-calculated concrete pad details online
- Ideal for use in car parks & commercial properties
- Other sizes available on request

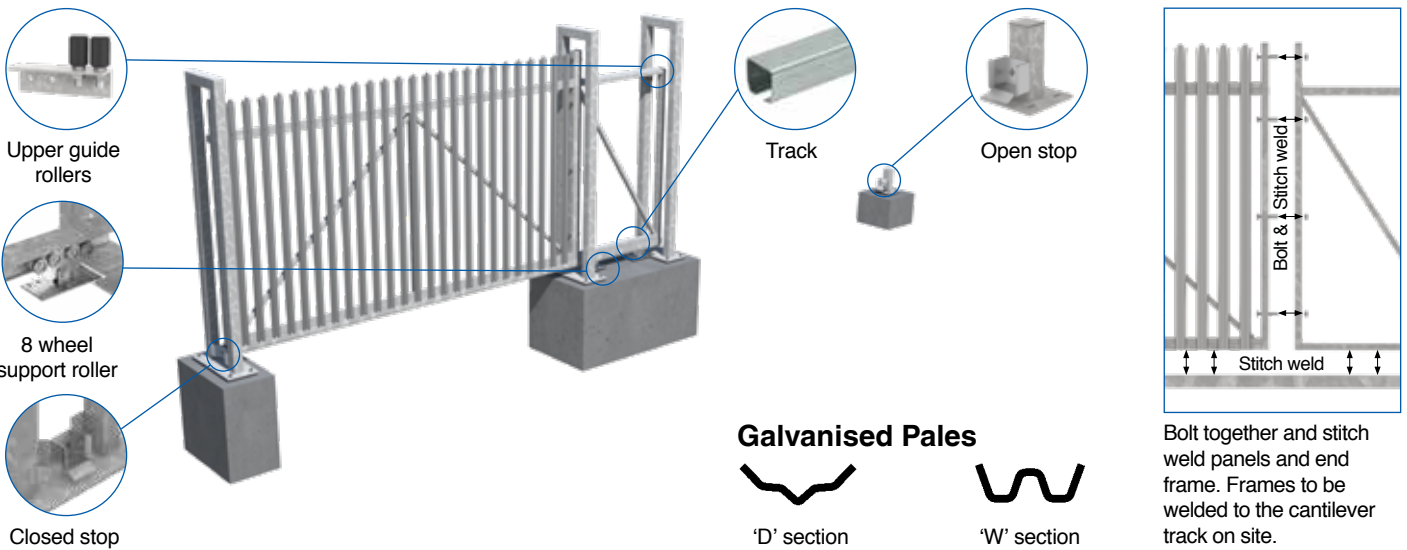

4m Cantilever Option

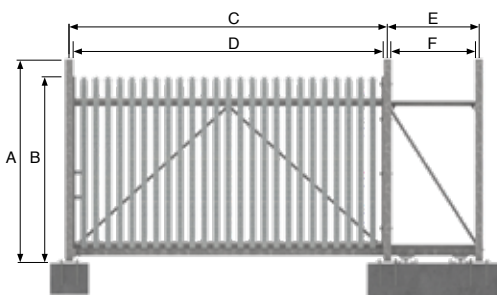

(A) mm	(B) mm	(C) mm	(D) mm	(E) mm	(F) mm	Right Opening Code	Left Opening Code
2000	1800	4100	4000	1180	1090	47SGC184RW	47SGC184LW
2600	2400	4100	4000	1180	1090	47SGC244RW	47SGC244LW
2000	1800	4100	4000	1180	1090	47SGC184RD	47SGC184LD
2600	2400	4100	4000	1180	1090	47SGC244RD	47SGC244LD

Kit includes 1 x panel, 1 x end frame, 4 x upper rollers, 2 x 8 wheel carriage blocks, 2 x guide rollers, 2 x end stops and 1 x 6m galvanised channel. For a lock order code: **05LSBZ50**, for keep order code: **05LSBZ** and for fixing plate order code: **47SGLPK**.

6m Cantilever Option

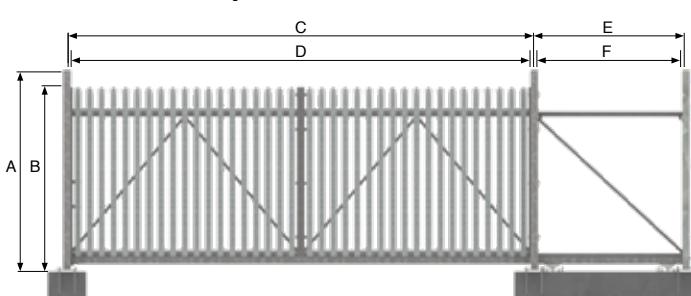

(A) mm	(B) mm	(C) mm	(D) mm	(E) mm	(F) mm	Right Opening Code	Left Opening Code
2000	1800	6100	6000	1880	1780	47SGC186RW	47SGC186LW
2600	2400	6100	6000	1980	1880	47SGC246RW	47SGC246LW
2000	1800	6100	6000	1880	1780	47SGC186RD	47SGC186LD
2600	2400	6100	6000	1980	1880	47SGC246RD	47SGC246LD

Kit includes 2 x panels, 1 x end frame, 4 x upper rollers, 2 x 8 wheel carriage blocks, 2 x guide rollers, 2 x end stops, 1 x 6m galvanised channel and 1 x 3m galvanised channel. For a lock order code: **05LSBZ50**, for keep order code: **05LSBZ** and for fixing plate order code: **47SGLPK**.



This GRP system can be used in the same environments as our pre-assembled version but being component based it allows you to make bespoke fences and gates to meet your exact requirements. Slopes are easily tackled using slope adaptor tubes. With the option of single or double gates the system is available in both grey and green.

- 1.8 & 3m fence heights
- Zero metal parts
- Lightweight
- Grey or green
- Non-conductive
- Long lasting
- UV resistant
- Adapts to slopes
- Single & double gates

Pointed Pale - With Or Without Pre-Drilled Holes

Top Hat Section Pale



Colour	Fence Height m	Pale Height m	Width mm	Un-drilled Code	Pre-drilled Code
Grey	1.8	1.75	88	19E181UG	19E181G
Green	1.8	1.75	88	19E181UGN	19E181GN
Grey	2.4	2.35	88	19E241UG	19E241G
Green	2.4	2.35	88	19E241UGN	19E241GN
Grey	3.0	2.95	88	19E301UG	19E301G
Green	3.0	2.95	88	19E301UGN	19E301GN

Concrete-In Post

'I' beam

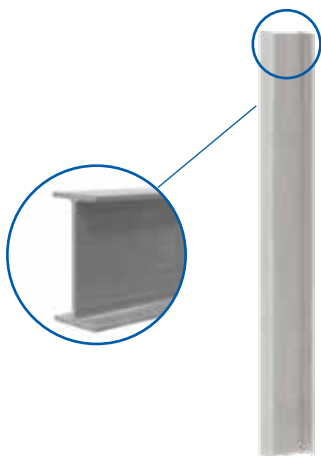

Horizontal Rail



Colour	Code
Grey	19E034G
Green	19E034GN

L 2720 x W 60 x D 60mm. 8mm thickness.

Cleats



Colour	Code
Grey	19E031G
Green	19E031GN

L 50 x W 60 x D 60mm. 8mm thickness.

Pale Fixing Bay Pack

For securing pale to horizontal rail



Sets per Pack	Code
60	19E037PALE

Set includes 1 x 30mm coach bolt, 1 x washer and 1 x shear nut. Use 4 sets per pale, 15 pales per bay.

'I' Beam Fixing Pack

For securing horizontal rail to post



Sets per Pack	Code
1	19E037IP

Set includes 4 x M10 x 30mm hex head bolts and nuts, 2 x M10 x 35mm hex head bolts and nuts.

Colour	Fence Height m	Post Height mm	Max. Post Centres mm	Width mm	Depth mm	Code
Grey	1.8	2365	2730	152	76	19E040G
Green	1.8	2365	2730	152	76	19E040GN
Grey	2.4	3165	2730	152	76	19E043G
Green	2.4	3165	2730	152	76	19E043GN

6.35mm thickness. For bolt down support foot see page 683.

- Drill pales through centre section, near the top and bottom of the pale
- Drill rails in midpoint along the centreline
- Use 50mm long bolts, washers, shear nuts and refit inserting slope adaptor in between rail and pale
- Hand tighten the complete bay and adjust to correct slope
- Fit rails to posts and then tighten all pale bolts to secure in position



Front view



Drill 2 centre holes per pale (top & bottom). For fixings use code: **19E037SA**.

Aerial view

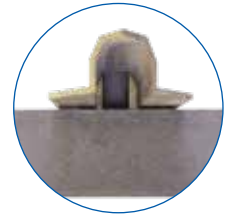

Secure slope adaptor tube between the horizontal rail and the pale.

Slope

Adaptor tube



Colour	Code
Grey	19E038G

Supplied in bag of 30. For fixings use code: 19E037SA.

Slope

Fixing pack



Sets per Pack	Code
1	19E037SA

Set includes 1 x 75mm coach bolt, 1 x washer and 1 x shear nut.

Support Foot For 'I' Beam Post



Colour	Code
Grey	19E036G

Used to create a bolt-down post when you cut a concrete I beam post to size.

Toggle Latch

Padlockable with padlock storage



Code
09FA32

For use with single gate. Adjusts vertically & horizontally. Polymer.

Single Gate - Concrete-In

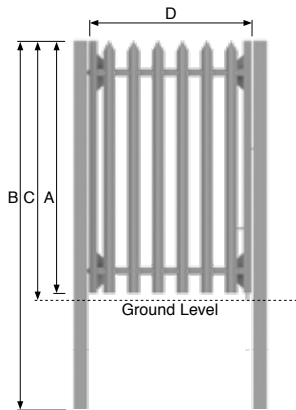

(A) m	Panel Height mm	(B) mm	(C) mm	(D) mm	Grey Code	Green Code
1.8	1750	2550	1800	1200	19ESLC1812G	19ESLC1812GN
2.4	2350	3150	2400	1200	19ESLC2412G	19ESLC2412GN

Includes posts and fittings. Frames are supplied pre-assembled and pales are fitted on site.

Double Gate - Concrete-In

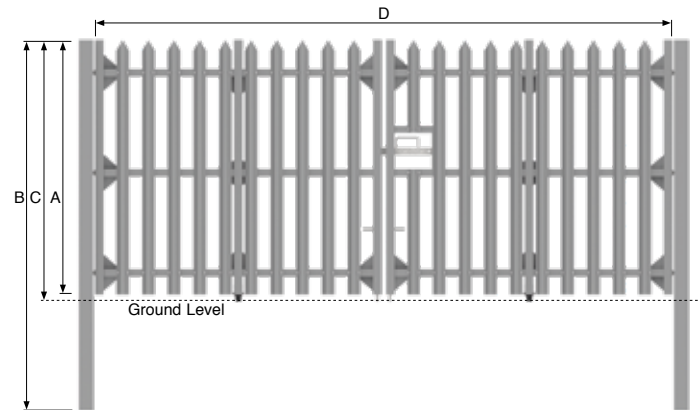

(A) m	Panel Height mm	(B) mm	(C) mm	(D) mm	Grey Code	Green Code
1.8	1750	2550	1800	4000	19EDLC184G	19EDLC184GN
2.4	2350	3150	2400	4000	19EDLC244G	19EDLC244GN

Includes posts and fittings. Frames are supplied pre-assembled and pales are fitted on site.

For galvanised palisade pales & gates see from page 675.

Spin Guard

Anti-vandal scaling barrier



- Steel
- Wrought Iron
- Gate
- Hardware
- Sliding Door Gear
- Gate Automation
- Mesh
- Decking & Subframe
- Flooring & Stair Treads
- Handrailing
- Fencing
- Fixings



This advanced anti-climb system provides an inexpensive and long lasting alternative to more conventional anti-climb systems such as razor wire or broken glass. Unique in design, Spin Guard is manufactured from a technically complex high tensile alloy, making it robust, tough and corrosion resistant. A perfect anti-climb security solution to a wide range of commercial, industrial and domestic applications.

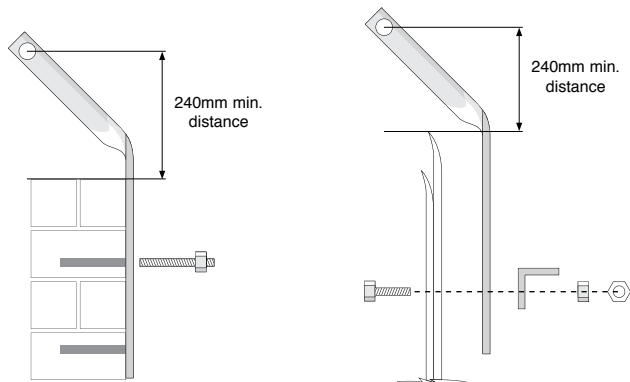
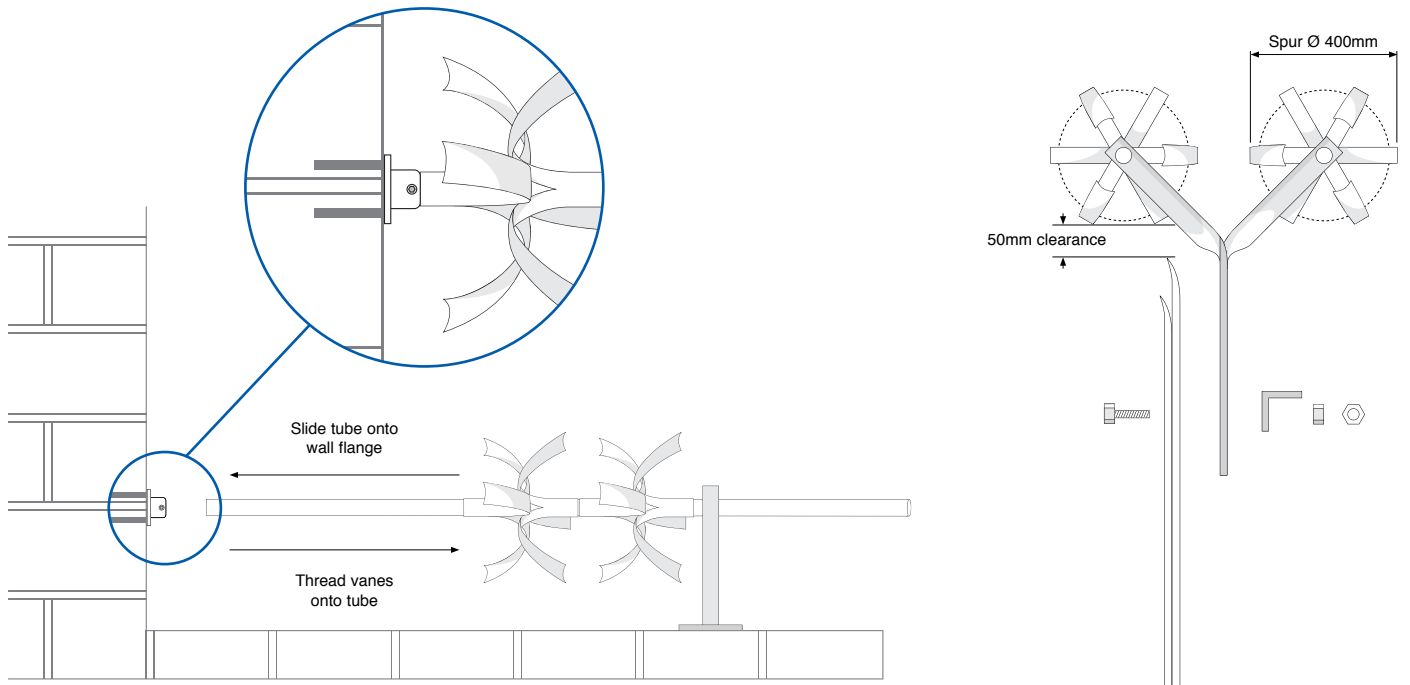

Minimum distance between centre of tube and top of wall.

Minimum distance between centre of tube and top of fence.



Spin Guard is also available in green & black, call your local branch for more details.



Steel

Wrought Iron Components

Gate Hardware

Sliding Door Gear

Gate Automation

Mesh

Decking & Subframe

Flooring & Stair Treads

Handrailing

Fencing

Fixings

Price Per Metre



Length m	Code
1	40001C

Includes vanes, shafts and internal connectors. Does not include brackets.

Vanes



Ø mm	Code
400	40002



Scan here for the installation guide.

Straight Arm Bracket



Height mm	Code
700	400012

For bolting to side of post.

Straight Arm Cranked Bracket



Height mm	Code
710	400011

For bolting to posts or side of wall. Fixing holes 19 x 10mm.

Bent Over Arm Bracket



Height mm	Code
570	400004

For bolting to posts or side of wall. Fixing holes 19 x 10mm.

Wall Bracket



Height mm	Code
360	400007

Base plate 120 x 100mm. Fixing holes Ø 10mm.

Corner Piece



Length mm	Code
265	400006

Wall Flange



Code
16131A

Shaft



Length m	Ø mm	Code
2	25	400003

Thickness 2mm.

Internal Tube Connector



Length mm	Code
130	400005

Through Bolt



Ø mm	Length mm	Code
M8	90	16248

Zinc plated.

Expanded Metal

Anti-vandal scaling barrier



- Steel
- Wrought Iron Components
- Gate Hardware
- Sliding Door Gear
- Gate Automation
- Mesh
- Decking & Subframe
- Flooring & Stair Treads
- Handrailing
- Fencing
- Fixings



Vanes are supplied in interlocking pairs, the paired vanes having five and six knuckles respectively. Vanes are separated with belled washers and overlapped spindle ends are connected to brackets.

Price Per Metre

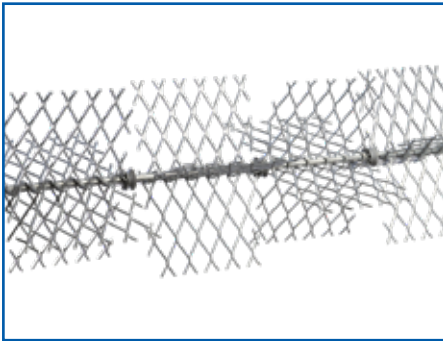

Length m	Code
1	4902250

Includes vanes, spindles, washers and brackets.



Top Pivot Bracket



Height mm	Code
335	4902257

Angle Bracket



Height mm	Code
300	4902256

Square Bolt & Shear Nut

With washer



Ø mm	Length mm	Code
M16	40	49022521

Star-Lock Washer



Ø mm	Code
28	49022524

To suit a Ø 16mm spindle.

Flat Washer



Ø mm	Code
50	4902252

To suit a Ø 16mm spindle. Nylon.

Through Bolt



Ø mm	Length mm	Code
8	90	16248

Zinc plated.

Spindle



Ø mm	Length m	Code
16	1.32	4902253

Cup Square Bolt



APPLICATIONS

- A domed head bolt with a square anti-spin shoulder mainly used for clamping timber or attaching ironmongery to timber

Ø mm	Length mm	Code
M10	35	5002CS10X35
M10	75	5002CS10X75
M10	80	5002CS10X80
M10	90	5002CS10X90

Vanes Pair

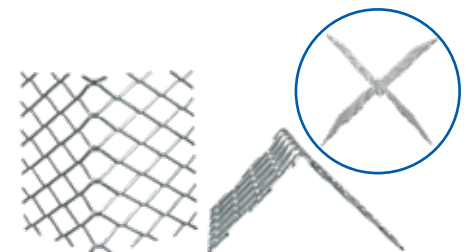

Code
4902251

Scan here for the installation guide.





Raptor is a more aesthetically pleasing alternative to the anti-vandal scaling barrier, and is made from fire resistant high impact durable plastic. A rotating central bar allows the individual units of Raptor to rotate freely, making it difficult to gain a foothold, therefore preventing criminal damage and trespass.

Raptor Assembled

With brackets



Length m	Colour	Code
1.32	Black	490001

Plastic. 10 spikes per length. Supplied with codes: 490001A, 490002, 4902256 and 49022521.

Raptor Assembled

Without brackets



Length m	Colour	Code
1.32	Black	490001A

Plastic. 10 spikes per length.



Top Pivot Bracket



Height mm	Code
210	490002

Angle Bracket



Height mm	Code
300	4902256

Square Bolt & Shear Nut

With washer



Ø mm	Length mm	Code
M16	40	49022521

Through Bolt



Ø mm	Length mm	Code
8	90	16248

Zinc plated.

Star-Lock Washer



Ø mm	Code
28	49022524

To suit a Ø 16mm bar.

Flat Washer



Ø mm	Code
50	4902252

To suit a Ø 16mm bar. Nylon.

Security Spikes Danger Sign

With pre-drilled holes



Size mm	Code
100 x 300	490015

Plastic.

Raptor is also available in green. Call your local branch for more details.

Scan here for the installation guide.



Security & Wall Spikes



- Steel
- Wrought Iron Components
- Gate Hardware
- Sliding Door Gear
- Gate Automation
- Mesh
- Decking & Subframe
- Flooring & Stair Treads
- Handrailing
- Fencing
- Fixings



Security Spike

Weld-fix



Length m	Height mm	Code
2	45	490010

Baby Spike

Screw-fix



Length m	Height mm	Width mm	Code
2	25	45	490011A

Sharktooth



Length m	Height mm	Width mm	Code
1.45	80	40	490012

Zinc plated and passivated.

Barracuda



Length m	Height mm	Width mm	Code
1.45	40	30	490013

Zinc plated and passivated.

Railhead Security spike

Welded to 30 x 8mm flat bar



Length m	Height mm	Code
1	138	051813052

Fixing holes Ø 9mm.

Railhead Security spike

Welded to 30 x 8mm flat bar



Length m	Height mm	Code
1	79	051813063

Fixing holes Ø 9mm.

Railhead Security Spike

Welded to 30 x 8mm flat bar



Length m	Height mm	Code
1	134	051813092

Fixing holes Ø 9mm.

Railhead Security Spike

Welded to 30 x 8mm flat bar



Length m	Height mm	Code
1	102	051813095

Fixing holes Ø 9mm.

Railhead Security Spike

Welded to 30 x 8mm flat bar



Length m	Height mm	Code
1	104	051813120

Fixing holes Ø 9mm.



For additional perimeter protection and to deter unauthorised access, barbed wire can be added to the tops of fences. As well as the traditional barbed wire we also sell a more contemporary razor wire, which is a more effective way of preventing intrusion along perimeter barriers for high security areas i.e. military institutions, government buildings and railways.

Wire

Concertina Medium Razor Barb Tape

Coil



Ø mm	Length m	Code
455	10	4801003
710	10	4801004
965	8 - 10	4801005

Barbed Wire

Coil



Length m	Line Wire Ø mm	Barbs mm	Barb Spacing Approx. mm	Code
15	2.5	2.00	85	4802002
200	1.6	1.45	100	4802010

Don't forget the safety gloves see page 690.

Merchant Barbed Wire

On wooden reel



Length m	Line Wire Ø mm	Barbs mm	Barb Spacing Approx. mm	Code
200	2.5	2.00	100	4802012
200	2.5	2.00	100	4802011*

Vulcan High Tensile Barbed Wire

On wooden reel



Length m	Line Wire Ø mm	Barbs mm	Barb Spacing Approx. mm	Code
200	2.0	2.00	75	4802003

*Rylock Green.

3 Wire Arms

45° Arm



45° Double Arm



Arm simply slides onto the post.

Straight Arm



Finish	To Suit mm	Code
Aluminium	□ 60 x 40	48036040A
PPC Green RAL 6005	□ 60 x 40	48036040G
PPC Green RAL 6005	□ 60 x 60	48036060G
PPC Black RAL 9005	□ 60 x 40	48036040B

380mm high. Fix to post using Tamper Drive fixings, see page 708.

Finish	To Suit mm	Code
Aluminium	□ 60 x 40	4803DA6040A

485mm high. Fix to post using Tamper Drive fixings, see page 708.

Finish	To Suit mm	Code
Aluminium	□ 60 x 40	4803SA6040A

380mm high. Fix to post using Tamper Drive fixings, see page 708.

Flat Bent Over Arm



D x T mm	Galvanised Code	PPC Black Code
30 x 6	4803004	4803004B

Overall height 580mm. Fixing slots 21 x 1.4mm.

Face Fixing Bent Over Arm



D x T mm	Code
30 x 6	4803003

Overall height 650mm. Fixing holes Ø 10mm.

Angle Bent Over Arm

For wire only



For wire see page 691.

D x W x T mm	Code
40 x 40 x 5	4803002

Black painted. Overall height 570mm. Fixing slots 25 x 9.5mm.

Barbed Wire Spacers



Height mm	Code
650	4803005

200mm hole spacing.

Accessories

Galvanised Staples

APPLICATIONS

- Heavily galvanised fencing staples to hold fencing firmly in place throughout its life



Size mm	Pack kg	Code
30 x 3.55	20.0	09S3020
40 x 4.00	10.0	09S4010
40 x 4.00	20.0	09S4020

Presser Point Staple

APPLICATIONS

- Well formed presser point staples, enter post & hold well, consistent shape & length



L x Ø mm	Pack kg	Code
20 x 2.00	2.5	09S202025
25 x 2.65	2.5	09S252025
30 x 3.35	2.5	09S302025
40 x 4.00	2.5	09S402025
50 x 4.00	2.5	09S502025

Round Wire Nail

APPLICATIONS

- For use in many various construction applications, typically driven in by hammer



L x Ø mm	Pack kg	Code
50 x 2.65	2.5	09A01025
65 x 3.35	2.5	09A01125
125 x 5.60	2.5	09A01525
150 x 6.00	2.5	09A01625

Warning Sign



Code
4801009

Size 250 x 90mm. Plastic.

Heavy Duty Mittens



Code
080618

For razor barb.

Red Superior Gauntlet



Code
60EAD009

Galvanised Wire



Ø mm	Length m	Code
0.90	100	040203090
1.25	2596	040201125
1.60	32	040203160
1.60	316	040202160
1.60	1580	040201160
2.00	20	040203200
2.00	203	040202200

Ø mm	Length m	Code
2.00	1000	040201200
2.50	640	040201264
3.15	80	040202315
3.15	400	040201315
4.00	250	040201400
5.00	160	040201500

Straining Eye Bolts

With nuts & washers



Ø mm	Length mm	Code
M6	152	0702027
M8	203	0702014
M10	203	0702012

Drivall Wire Strainer



APPLICATIONS

- Fully automatic chain grab. Will strain slack or broken wire in centre-strain or round fencing post

Code
080619

Wire Cutters

For Ø 7mm wires



L x W x D mm	Code
190 x 60 x 18	080569

Ratchet Post Radisseurs



Code
09FA532

Fixing hole Ø 11mm.

Radisseurs



Length mm	Code
100	09FA531
120	09FA11

Fixing hole Ø 6mm.

Strainer



Model	Code
Economy	0702009

Wire Vice



To Suit Wire Ø mm	Code
2.00 - 3.25	09FA01
3.25 - 4.20	09FA02

Gripple Wire Vice



To Suit Wire Ø mm	Code
2.50 - 3.15	09FA09

Wire Link



To Suit Wire Ø mm	Code
2.50 - 3.15	09FA10

Barrel Strainer



Ø mm	Code
M8	0702022

Spiral Lashing Rod



Length mm	Code
150	09FA515

Make Life Easier With Online Ordering!



- Order products 24/7
- Check prices
- View purchase history
- Create quotes

Visit www.fhbrundle.co.uk

- Steel
- Wrought Iron
- Gate Hardware
- Sliding Door Gear
- Gate Automation
- Mesh
- Decking & Subframe
- Flooring & Stair Treads
- Handrailing
- Fencing
- Fixings



As one of the UK's leading suppliers, we are able to provide from stock, a range of pedestrian safety barriers to suit all site conditions.

Concrete-In Barriers

Pattern One

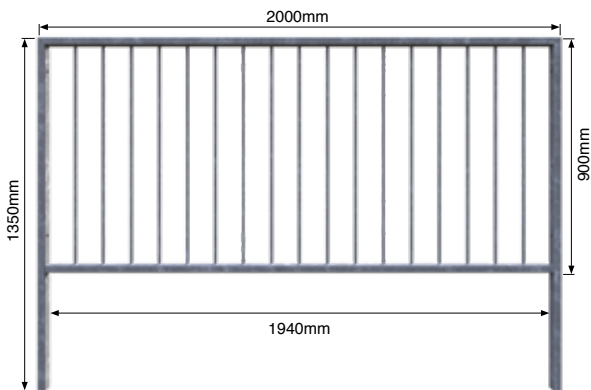

Infill Panel Bar Ø mm	Code
12	22001

Length of stile into a concrete foundation is 300mm. Ø 13mm fixing holes to join panels together, two on each side. Supplied with two M10 x 80mm joining bolts.

Pattern Three

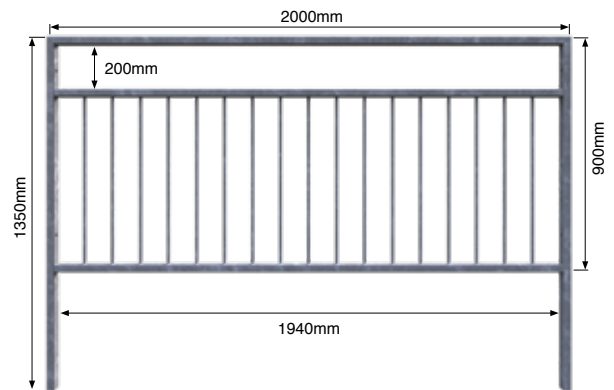

Infill Panel Bar Ø mm	Code
12	22003

Length of stile into a concrete foundation is 300mm. Ø 13mm fixing holes to join panels together, two on each side. Supplied with two M10 x 80mm joining bolts.

Bolt-Down Barriers

Pattern One

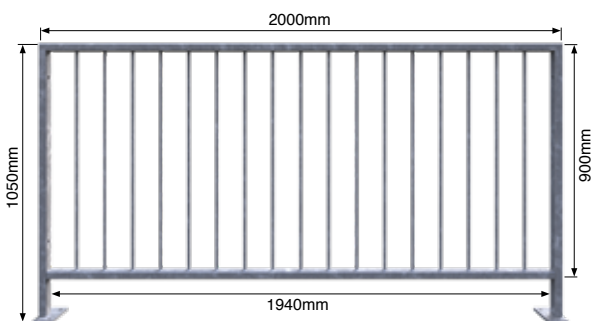

Infill Panel Bar Ø mm	Base Plate mm	Code
12	150 x 75	22001B

Adjoining panels will make 150 x 150mm base plate. Ø 13mm fixing holes to join panels together, two on each side. Supplied with two M10 x 80mm joining bolts. Ø 17mm base plate fixing holes to suit a Ø 16mm fixing bolt.

Pattern Three

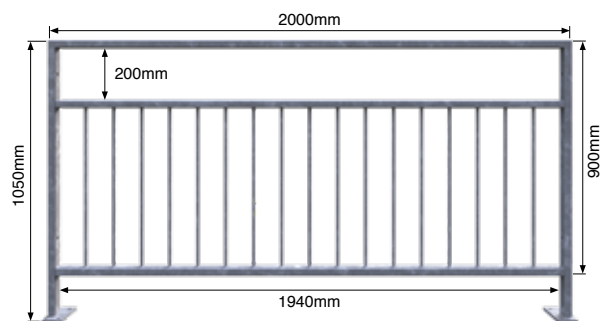

Infill Panel Bar Ø mm	Base Plate mm	Code
12	150 x 75	22003B

Adjoining panels will make 150 x 150mm base plate. Ø 13mm fixing holes to join panels together, two on each side. Supplied with two M10 x 80mm joining bolts. Ø 17mm base plate fixing holes to suit a Ø 16mm fixing bolt.

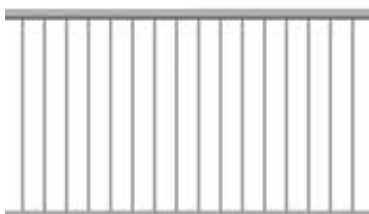

Pedestrian Panel

Post Width Centre to Centre mm	Top & Bottom Rail Ø mm	Height mm	Bar Ø mm	Gap Between Bars mm	Code
1500	48.3	1000	12	92.6	1603PEDD15

For our range of crash barrier see page 694.



Our range of vehicle barriers are a simple, cost-effective way to restrict vehicle access to your premises. Available in a range of sizes, the height restriction barrier also restricts access for vehicles over the permitted limit, preventing damage to property or difficulty in exiting. Available galvanised as standard or galvanised and polyester powder coated to order.

Vehicle Barrier

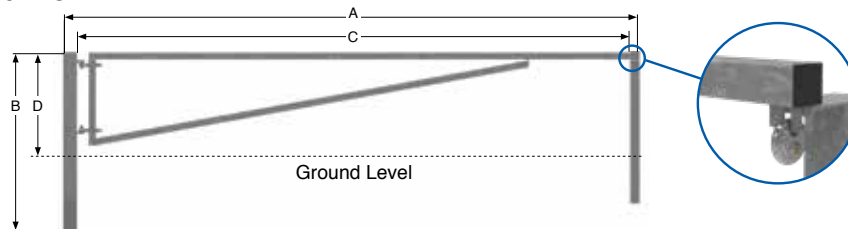

(A) mm	(B) mm	(C) mm	(D) mm	Code
3200	1650	3000	900	54CP3S
4200	1650	4000	900	54CP4S
5200	1650	5000	900	54CP5S

Supplied with posts and fixings. Barrier can be secured using padlock code: **53099**.

Extra Catch Post



Height mm	Code
1350	54BARP

Vehicle Height Restriction Barrier

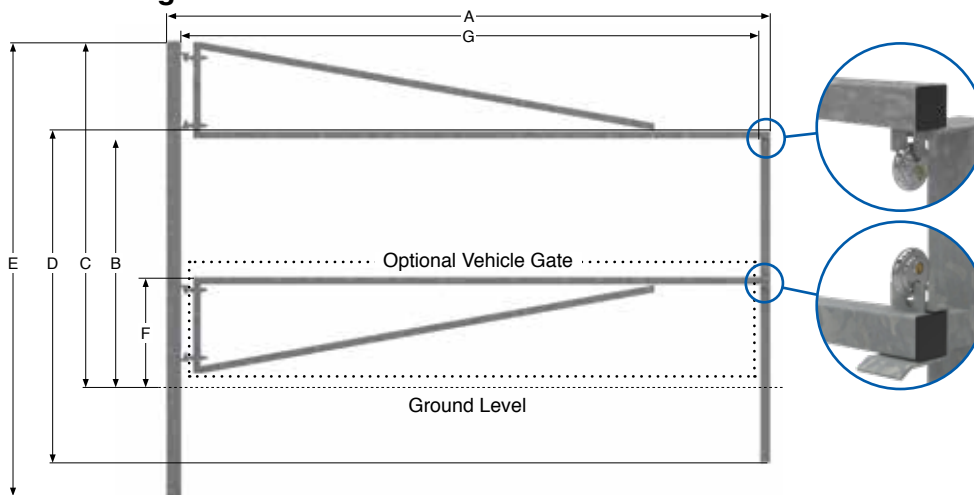

(A) mm	(B) mm	(C) mm	(D) mm	(E) mm	(F) mm	(G) mm	Combination Barrier Code	Height Restriction Barrier Code
3200	2100	2930	2797	3930	900	3000	54CP3D	54HR3D
4200	2100	2930	2797	3930	900	4000	54CP4D	54HR4D
5200	2100	2930	2797	3930	900	5000	54CP5D	54HR5D

Supplied with posts and fixings. Barrier can be secured using padlock code: **53099**. 3000mm catch post available to order.

Padlock



Code
53099

Supplied with 2 keys.



You can order online 24 hours a day, 7 days a week. Visit our website: www.fhbrundle.co.uk

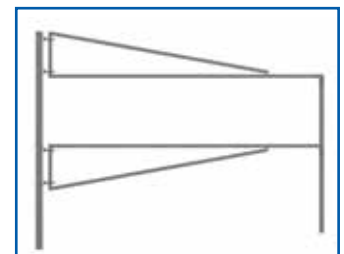

Combination Barriers include optional vehicle gate.

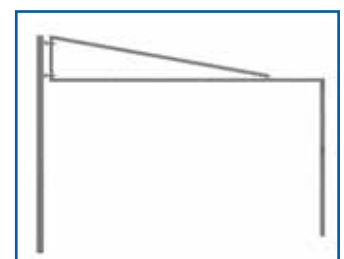

Height Restriction Barriers do not include optional vehicle gate.

Armco Crash Barrier



Traditional



For protecting people, property and plant installations from vehicle impact. Crash barrier is widely used along roads, in factories, vehicle parks and industrial premises.

Beams

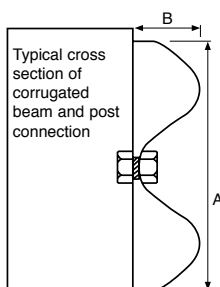

Nominal Length mm	Thickness mm	Overall Length mm	(A) mm	(B) mm	Code
1600	3.0	1900	310	85	120116
3200	3.0	3500	310	85	120132

Nominal Length mm	Thickness mm	Overall Length mm	(A) mm	(B) mm	Code
3200	1.5	3500	310	85	120132L

Magnelis coated. Please order 8 x lap bolts code: **120401**.

Please order 8 x lap bolts code: **120401**.

Beam Converter

For converting a single beam into a double beam

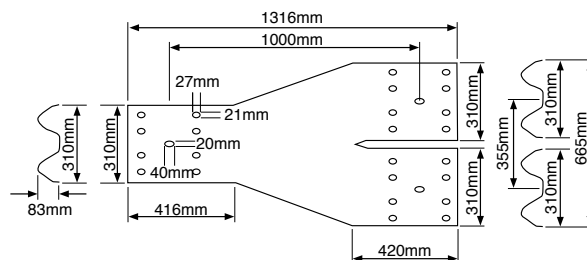

Nominal Length mm	Thickness mm	Overall Length mm	Code
1316	3.0	1482	120134

Please order 12 x lap bolts code: **120401**.

Posts

Bolt-Down 'Sprung'

Suitable for single beam



Height mm	Plate mm	Code
610	298 x 200	120101B

Plate fixing holes Ø 28mm. Please order 1 x post bolt code: **120501**.

Bolt-Down 'Sprung'

Suitable for double beam



Height mm	Plate mm	Code
760	298 x 200	120102

Plate fixing holes Ø 28mm. Please order 2 x post bolts code: **120501**.

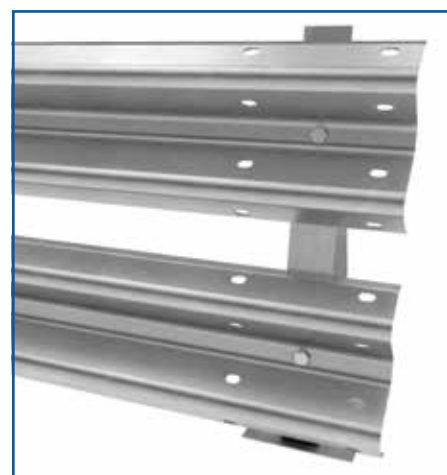

The above example shows 2 x code: **120116** attached to 1 x code: **120102** double beam sprung post.



Posts

Concrete-In 'I'



Height mm	Code
1200	120212B
1500	120215B
1800	120218B

Post 150 x 75mm. Please order 1 x post bolt code: **120501**.

Concrete-In 'Z'



Height mm	Code
1200	120412
1500	120415

Please order 1 x post bolt code: **120501**.

Bolt-Down 'I'



Height mm	Code
560	120201B
610	120203B
760	120202B

Post 150 x 75mm. Base plate 330 x 250mm. Base plate fixing holes Ø 22mm. Please order 1 x post bolt code: **120501**.

Bolt-Down 'Z'



Height mm	Code
560	120411
610	120403
760	120402

Base plate 200 x 200mm. Base plate fixing holes Ø 18mm. Please order 1 x post bolt code: **120501**.

Corners

External 90°

Adds 288mm



Length mm	Code
602	120303

Internal 90°

Adds 294mm

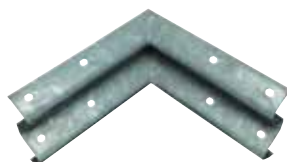

Length mm	Code
602	120304

External Flexible

Adds 322mm



Length mm	Code
588	120307

Internal Flexible

Adds 322mm



Length mm	Code
588	120308

Ends

Scroll

Adds 138mm



Length mm	Code
446	120306

FishTail

Adds 392mm



Length mm	Code
700	120301

Armco Crash Barrier



Traditional



Protective Corners, Ends & Caps

External 90° Corner

Silver diamond grade reflectors



Colour	Code
Yellow	120318EY

Polymer.

Internal 90° Corner

Silver diamond grade reflectors



Colour	Code
Yellow	120318iY

Polymer.

External 135° Corner

Silver diamond grade reflectors



Colour	Code
Yellow	120319EY

Polymer.

Internal 135° Corner

Silver diamond grade reflectors



Colour	Code
Yellow	120319iY

Polymer.

FishTail End

With yellow reflectors



Colour	Code
Yellow	120313Y
Black	120313B

Polymer.

End Protector

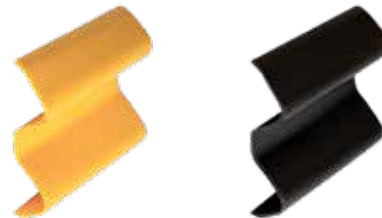

Colour	Code
Yellow	120305
Black	120305B

Rubber.

Safety End

With yellow reflectors



Colour	Code
Yellow	120312Y
Black	120312B

Must drill Ø 11mm holes in beam to fit. Polymer.

Safety End

With yellow reflectors



Colour	Code
Yellow	120311Y
Black	120311B

Polymer.

'Z' Beam Protective Cap



Colour	Code
Yellow	120315Y

Rubber.

'I' Beam Protective Cap



Colour	To Suit Post mm	Code
Yellow	127 x 76	120314Y
Yellow	150 x 75	120314BY
Black	150 x 75	120314BB

Rubber.



Steel

Wrought Iron Components

Gate Hardware

Handrail Post

For use with $\text{\O} 48.3\text{mm}$ tube



Height mm	Code
1100	1205601

For use with 560mm Bolt-Down Post code: 120201B.



Sliding Door Gear

Gate Automation

Mesh

Hi Viz Reflector

Bolt-on

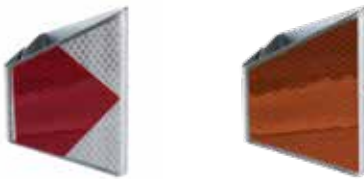

Colour	Code
Red & White	120316
Orange	120317



Decking & Subframe

Flooring & Stair Treads

Handrailing

Post Bolt

With nuts & 2 washers
1 per post



\O x Length mm	Code
M16 x 50	120501

Lap Bolt

With nuts & 2 washers
8 per beam



\O x Length mm	Code
M16 x 35	120401

Tarmac Fixing

With washer



\O x Length mm	Code
M8 x 50	1205TF08
M10 x 55	1205TF10
M12 x 80	1205TF12

Supplied with rubber sleeve. B.Z.P.

Tube



\O mm	Code
48.3	160248

6.5m long. Other lengths available.

Fencing

Fixings

Demi Armco Crash Barrier



Half size



Half the size, half the price, same protection of traditional Armco.

- Smaller, lighter beams that still offer great site protection
- Protect machinery, plant and racking from vehicle impact
- Galvanised steel for up to 30 years maintenance free life
- Quick and easy to install

Beams

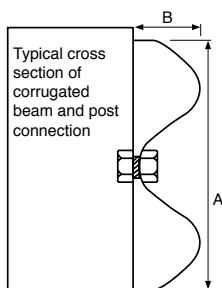
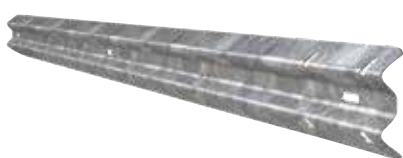

Traditional Armco crash barrier is 310mm versus our small crash barrier is 155mm

Nominal Length mm	Thickness mm	Overall Length mm	(A) mm	(B) mm	Code
3200	2.5	3500	155	42	121132

Please order 8 x lap bolts code: 121401.

Posts Bolt-Down 'Z'



Height mm	Code
560	120411*
760	120402

Base plate 200 x 200mm. Base plate fixing holes Ø 18mm. Please order 1 x post bolt code: 120501. *120411 does not have a lower hole, the image is for illustration purposes only.

Corners

External 90°
Adds 115mm



Length mm	Code
450	121303

Internal 90°
Adds 115mm



Length mm	Code
450	121304

Bent Corner 168°



Length mm	Code
400	121307

Ends

Terminal End
Adds 134mm



Length mm	Code
345	121302

Fixings

Lap Bolt
With nuts & 2 washers



Ø x Length mm	Code
M12 x 35	121401





Metal Bollards Concrete-In



Ø mm	Height mm	Code
100	1000	53003

700mm visible above ground. Primer painted black with reflective tape.

Bolt-Down



Ø mm	Height mm	Code
100	1000	53003B

Base 200 x 200 x 10mm. Fixing holes Ø 14mm. Primer painted black with reflective tape Underside treated with transparent anti-rust paint.

Bolt-Down



Ø mm	Height mm	Code
76	900	53006

Base 150 x 150 x 10mm. Fixing holes Ø 14mm. PPC yellow and black.

Bolt-Down



Ø mm	Height mm	Code
114	1200	53007

Base 200 x 200 x 10mm. Fixing holes Ø 14mm. PPC yellow and black.

Corner Guard



Length mm	Code
800	53901

W 100 x D 100 x T 8mm. High intensity black rubber. Black with yellow reflectors.

Thermoplastic Polyurethane (TPU) Bollards Black High Intensity

Lightweight



Ø mm	Height mm	Code
100	750	53001B

Base Ø 200mm. Fixing holes Ø 13.5mm. 3 reflective white tapes.

For our range of post & column protectors see from page 703.

Removable Bollards & Parking Posts

Hinged Parking Post



Ø mm	Height mm	Code
60	610	53010

Base Ø 155mm. Fixing holes Ø 12mm. Supplied with 2 keys. Polyester powder coated yellow.

Hinged Parking Post



Ø mm	Height mm	Code
60	610	53011

Base Ø 155mm. Fixing holes Ø 12mm. Supplied 2 keys.

Removable Bollard

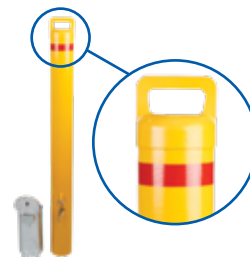

Ø mm	Height mm	Code
102	900	53012

Case height 225mm. Supplied with padlock and 2 keys. Polyester powder coated yellow.

Removable Bollard



Ø mm	Height mm	Code
102	900	53013

Case height 225mm. Supplied with padlock and 2 keys.

Removable Security Post



□ mm	Height mm	Code
80	1050	05SP02

800mm visible above ground. Built-in 5-lever Chubb deadlock.

Telescopic Bollard



Ø mm	Height mm	Code
100	540	53014

750mm below ground. Ø 160mm case in ground. Supplied with padlock and 2 keys.

Accessories

Tarmac Fixing With Washer



Ø mm	Code
M8	1205TF08
M10	1205TF10
M12	1205TF12

Supplied with rubber sleeve. BZP.

Padlock



Code
53099

Supplied with 2 keys.

Padlock



Code
05SP01PLK

Supplied with 2 keys.

Zinc Plated Steel Padlock



Code
51PLK50L

Supplied with 3 keys. Suitable for Fortitude double leaf gates from page 630.



You can order online 24 hours a day, 7 days a week. Visit our website: www.fhbrundle.co.uk



Free delivery on all orders over £150.00



Our new handy range of weldable steel components helps the steel fabricator make his own bollards in three sizes of $\text{\O} 48.3\text{mm}$, 76.1mm and 114.3mm . With a selection of post tops, decorative collars, chain attachments and base plates you can easily design your own bollards at competitive prices. Cast steel allows the finished bollard to be galvanised, powder coated or painted.

Bollard Top



To Suit \O mm	Code
48.3	05PT48
76.1	05PT76
114.3	05PT114

Not suitable for welding or galvanising.

Bollard Cap With Flange

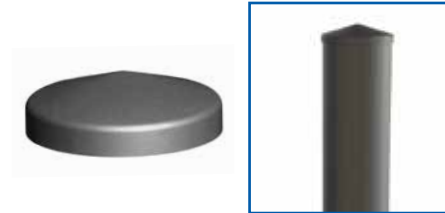

To Suit \O mm	Code
48.3	0515464
76.1	0515466
114.3	0515469

Bollard Cap



To Suit \O mm	Code
48.3	16133D
76.1	320376
114.3	3203114

Plastic.

Decorative Collar



To Suit \O mm	Code
48.3	05CC48
76.1	05CC76
114.3	05CC114

Not suitable for welding or galvanising.

Base Plate



To Suit \O mm	Code
48.3	1301207D

Fixing holes 11 x 16mm.

Bollard Tube



\O mm	Length m	Code
48.3	7.5 - 7.6	300648332
76.1	7.5 - 7.6	300676132
114.3	7.5 - 7.6	30061143

3mm thickness.

We also stock a huge range of concrete-in & bolt-down bollards from page 699.

Steel

Wrought Iron Components

Gate Hardware

Sliding Door Gear

Gate Automation

Mesh

Decking & Subframe

Flooring & Stair Treads

Handrailing

Fencing

Fixings



Chain

Welded Long Link



Finish	Ø mm	A mm	Code
Galvanised	4.0	26	05C0226
BZP	5.0	35	1412*
Galvanised	6.5	36	05C0236

*BZP.

Welded Long Link

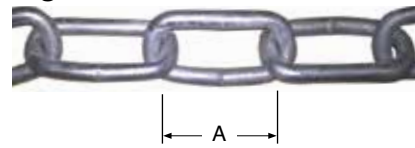

Finish	Ø mm	A mm	Code
Galvanised	8	44	05C0825

Welded Spiked Alternate Long Link



Finish	Ø mm	A mm	Code
Galvanised	6	50	05C0204

For decorative chains see page 181.

Fittings

Staple On plate



mm	Staple Length mm	Code
50	28	0505CF01

For permanently fixing chain or rope to a wall, fence or post. 28mm from back plate to front of staple. 22mm between centres. Galvanised.

Hook On Plate



mm	Staple Length mm	Code
50	65	0505CF02

End fitting for mounting onto fence posts or walls. Galvanised.

Ring On Plate



mm	Ring Thickness mm	Code
50	8	05C0201

End fitting for mounting onto fence posts or walls. Galvanised.

Single Hook



Ø mm	Code
M10	0505CF03

To attach chain to 4" wood and concrete end posts. Galvanised.

Quick Repair Link



Ø mm	Code
6	1415
8	14158

BZP.

'D' Shackle



Ø mm	Code
6	1418B
8	1419



Our safety barriers have a wide range of applications. Widely used for racking protection, plant and machinery, or in areas where there is a likelihood of accidental damage by moving vehicles. They can be used in trolley bays and also as pedestrian protection. Manufactured from galvanised mild steel with a PPC yellow RAL 1003 coating for maximum visibility, the protectors are designed to withstand knocks and bumps from car bumpers that occur daily.

Concrete-In

Safety Barrier



Ø mm	Height mm	Galvanised Code	PPC Yellow Code
48.3	950	22SBC95	22SBC95Y

Approx. internal measurement 1176mm.

90° Post Protector



Ø mm	Height mm	Galvanised Code	PPC Yellow Code
48.3	900	2290PPC90	2290PPC90Y

Approx. internal measurement 551 x 551mm.

180° Post Protector



Ø mm	Height mm	Galvanised Code	PPC Yellow Code
48.3	800	22180PPC80	22180PPC80Y

Approx. internal measurement W 603 x D 651mm.

Bolt-Down

Safety Barrier



Ø mm	Height mm	Galvanised Code	PPC Yellow Code
48.3	1100	22SBB11	22SBB11Y

Approximate internal measurement between base feet 1036mm. Suitable for M10 bolt code: 5002HCS10100.

90° Post Protector

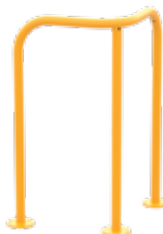

Ø mm	Height mm	Galvanised Code	PPC Yellow Code
48.3	1100	2290PPB11	2290PPB11Y

Approximate internal measurement between base feet 411 x 411mm. Suitable for M10 bolt code: 5002HCS10100.

180° Post Protector



Ø mm	Height mm	Galvanised Code	PPC Yellow Code
48.3	500	22180PPB50	22180PPB50Y

Approximate internal measurement between base feet W 463 x D 511mm. Suitable for M10 bolt code: 5002HCS10100.

Use With Our Mesh Panels



Concrete-In



Bolt-Down With welded feet



Bolt-Down With tube clamp feet



No.	Mesh Panel Size mm	Mesh Inch	Mesh mm (approx)	Gauge g	Frame Ø mm	Mesh Code	Barrier Code
1	470 x 1082	2 x 2	50 x 50	10	8	0102006B	22SCB95*
2	972 x 1082	2 x 2	50 x 50	10	8	0102007B	22SBB11*
3	826 x 1082	2 x 2	50 x 50	10	8	0102008B	22SCB95*

For tube clamp feet on number 3 use code: 16132D.

Single Mesh Clip



Ø mm	Galvanised Code	Stainless Steel 316 Code
48.3	16170D	1806170D