



F.H. BRUNDLE

SERVING THE TRADE SINCE 1889



**ALUMINIUM
FENCING**



**STEEL RAILINGS &
COMPOSITE DECKING**



**GLASS
BALUSTRADING**

Summer Collection 2023

Gabions



Gabions offer the most cost-effective and rapidly deployed solution for retaining wall systems. They are used in a huge range of situations including landscaping to stabilise earth movement and canal refurbishment, all while achieving a robust yet natural look. Our welded mesh gabion baskets are made of 3mm galvanised steel wire and are able to keep their shape, free from bulges and depressions, and fit easily against walls.

Basket



H x W x D mm	Mesh Size	Code
0.5 x 0.5 x 0.5	3 x 3"	01085553
1.0 x 0.5 x 0.5	3 x 3"	01081553
1.0 x 1.0 x 0.5	3 x 3"	01081153
1.0 x 1.0 x 1.0	3 x 3"	01081113
1.5 x 0.5 x 0.5	3 x 3"	010815553
1.5 x 1.0 x 0.5	3 x 3"	010815153
1.5 x 1.0 x 1.0	3 x 3"	010815113
2.0 x 1.0 x 1.0	3 x 3"	01082113

Supplied with 12 spirals for basket assembly.

Tube Clamps



Ø 42.4 & 48.3mm Posts

End

Mid

Corner



Short Tee



Railing Base Flange



Fittings & Galvanised Tube

Long Tee



Internal Joint



Two Socket Cross



Galvanised Tube



90° Elbow



For up to date prices visit www.fhbrundle.co.uk



FORTITUDE™
FENCING SYSTEMS

A sturdy range of ready-to-install railings and gates with a choice of railheads that are built to last. Our metre rate codes are supplied with 1 x panel, 1 x mid post, cleats and fixings. Remember to order an extra post to finish a run.

- Designed for peace of mind
- Bolt-down or concrete-in
- Matching single & double leaf gates available
- Fence heights from 0.9 - 1.8m

Fleur De Lis



CONCRETE-IN

**From
£73.00
Per Metre**

Description	Fence Height m	Metre Code
Galvanised	1.2	51RTC1212M
Powder Coated Black	1.2	51RTC1212BM

Codes are for a concrete-in post system

Vertical Bar



CONCRETE-IN

**1.2m from
£55.00
Per Metre**

Description	Fence Height m	Metre Code
Galvanised	0.5	51WVBC1254M
	0.9	51VBC0912M
	1.2	51VBC1212M
Powder Coated Black	0.5	51WVBC1254BM
	0.9	51VBC0912BM
	1.2	51VBC1212BM

Codes are for a concrete-in post system.

Forest



CONCRETE-IN

**1.2m from
£67.00
Per Metre**

Description	Fence Height m	Metre Code
Galvanised	0.5	51WCTC1254M
	1.2	51CTC1212M
	0.5	51WCTC1254BM
Powder Coated Black	1.2	51CTC1212BM

Codes are for a concrete-in post system.



ROSPA Bow Top Fencing



1.2m from
£58.00
Per Metre

Description	Fence Height m	Metre Code
Galvanised	1.0	51RBTC1012M
	1.2	51RBTC1212M
Powder Coated Black	1.0	51RBTC1012BM
	1.2	51RBTC1212BM

Codes are for a concrete-in post system.

Bow Top



1.2m from
£53.00
Per Metre

Description	Fence Height m	Metre Code
Galvanised	0.5	51WBTC1254M
	0.9	51BTC0912M
	1.2	51BTC1212M
	1.5	51BTC1516M
	1.8	51BTC1816M
	1.8	51BTC1820M
Powder Coated Black	0.5	51WBTC1254BM
	0.9	51BTC0912BM
	1.2	51BTC1212BM
	1.5	51BTC1516BM
	1.8	51BTC1816BM
	1.8	51BTC1820BM

Codes are for a concrete-in post system.

Sphere Top



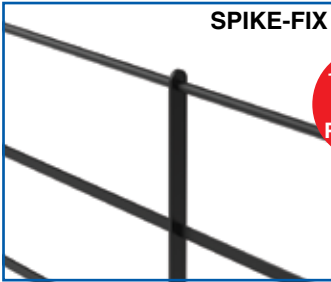
1.2m from
£73.00
Per Metre

Description	Fence Height m	Metre Code
Galvanised	0.5	51WSTC1254M
	0.9	51STC0912M
	1.2	51STC1212M
Powder Coated Black	0.5	51WSTC1254BM
	0.9	51STC0912BM
	1.2	51STC1212BM

Codes are for a concrete-in post system.



Estate Fencing



SPIKE-FIX

**1m from
£23.00
Per Metre**

Description	Fence Height m	Metre Code
Galvanised	1.0	65FPS09M
	1.2	55FP12M
Powder Coated Black	1.0	65FPS09BM
	1.2	55FP12BM

Codes are for a spike-fix post system.

Aluminium Railings



Simplicity Aluminium Railings



**1m from
£31.50
Per Metre**

Post	Fence Height m	Metre Code
Bolt-down	1.0	59RP10BM
	1.2	59RP11BM
Concrete-in	1.0	59RP10CBM
	1.2	59RP11CBM

Mesh Fencing



Betafence Nylofor® 3M



1.7m from
£24.50
Per Metre

Fence Height m	Powder Coated Black Metre Code	PVC Green Metre Code
1.7	56NY3M18BM	56NY3M18GM
2.0	56NY3M20BM	56NY3M20GM
2.4	56NY3M24BM	56NY3M24GM

- Mesh Size: 200 x 50mm
- Posts: Twilfix® 2000 system
- Post Centers: At approximately 3.025m
- Finish: Powder coated green or black on a pre-galvanised wire

MeshMaster™ Safe Top



1.2m from
£38.50
Per Metre

Fence Height m	Powder Coated Black Metre Code	PPC Green Metre Code
1.2	54ST12BM	54ST12GM
1.5	54ST15BM	54ST15GM
1.8	54ST18BM	54ST18GM

- Mesh Size: 150 x 50mm
- Posts: Twilfix® 2000 system
- Post Centers: At approximately 3.025m
- Finish: Powder coated green or black on a pre-galvanised wire

Privacy Fencing Roll

- Privacy for residential properties, terraces & balconies
- Protection against adverse weather
- Helps reduce unwanted noise from outside the property
- UV resistant

Green



From
£69.00



Black

Colour	Height mm	Length Linear m	Code
Green	190	50	54PFR190G
Black	190	50	54PFR190B

Can be used with 3M, 3D & 2D.



Betafence Nylofor® 2D



1.8m from
£31.50
Per Metre

Fence Height m	Powder Coated Black Metre Code	PPC Green Metre Code
1.8	56NY2D18BM	56NY2D18GM
2.0	56NY2D20BM	56NY2D20GM
2.4	56NY2D24BM	56NY2D24GM

- Mesh Size: 200 x 50mm
- Posts: Twilfix® 2000 system
- Post Centers: At approximately 2.525m
- Finish: Powder coated green or black on a pre-galvanised wire

MeshMaster™ Palex



1.8m from
£43.00
Per Metre

Fence Height m	Powder Coated Black Metre Code	PPC Green Metre Code
1.8	–	54PAL18GM
2.0	–	54PAL20GM
2.4	54PAL24BM	54PAL24GM

- Mesh Size: Varies to 50 x 50mm max
- Posts: Twilfix® 2000 system
- Post Centers: At approximately 2.975m
- Finish: Powder coated green or black on a pre-galvanised wire

Betafence Securifor® 358



2m from
£77.00
Per Metre

Fence Height m	Powder Coated Black Metre Code	PPC Green Metre Code
2.0	56SE35820BM	56SE35820GM
2.4	56SE35824BM	56SE35824GM
3.0	56SE35830BM	56SE35830GM

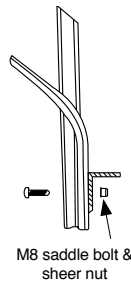
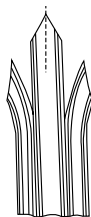
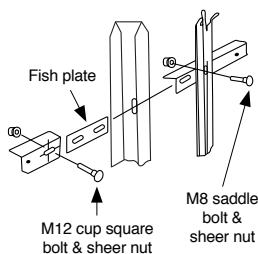
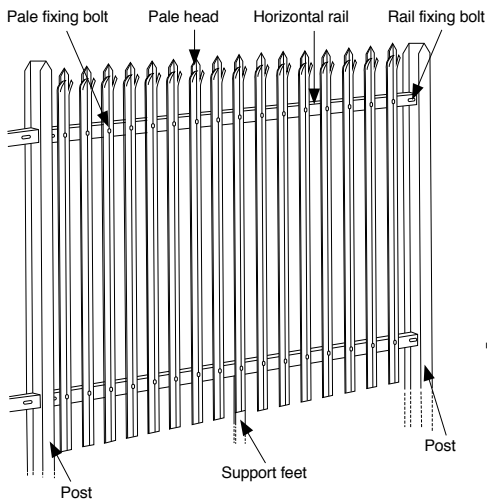
- Mesh Size: 76.2 x 12.7mm
- Posts: Securifor® 358 posts
- Post Centers: At approximately 2.44m
- Finish: Powder coated green or black on a pre-galvanised wire

We stock a full range of pedestrian and vehicular mesh access gates



Palisade Fencing

Discounts
for larger
quantities



'D' Section Pale



'W' Section Pale



CONCRETE-IN

1.8m from
£65.00
Per Metre

Also available in bolt-down posts.

Profile	Fence Height m	Metre Code
D	1.8	470218CDM
	2.0	470220CDM
	2.1	470221CDM
	2.4	470224CDM
W	3.0	470230CDM
	1.8	470218CWM
	2.0	470220CWM
	2.1	470221CWM
	2.4	470224CWM
	3.0	470230CWM

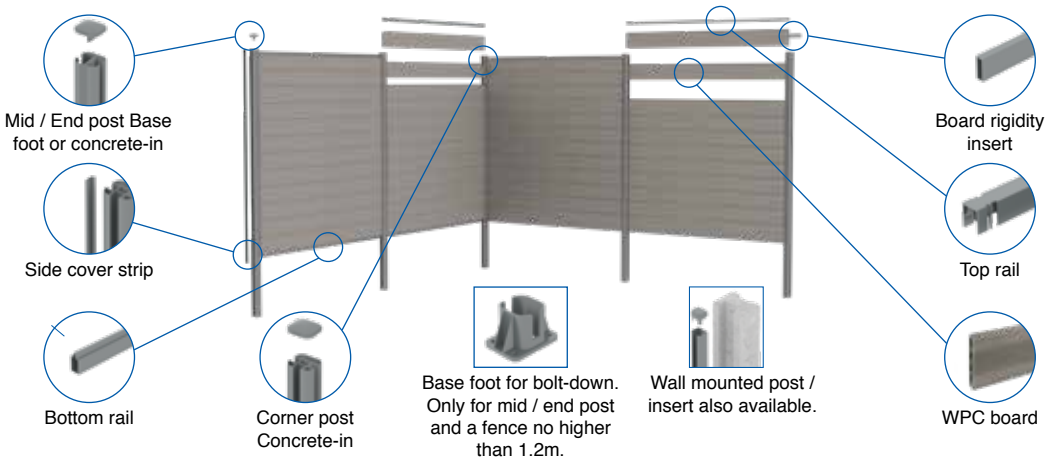
We stock a full range of pedestrian,
double leaf and sliding gates.





WPC Range - looks amazing and is both easy to use and cost effective.

- Long-lasting & low maintenance
- Available in 4 colours - Birch, Chestnut, Ebony & Twilight Grey
- Standard fence height 1.8m with 1.8m post centres
- Aluminium concrete-in or bolt-down post options available
- Posts & boards can be cut to create a lower or narrower fence
- No more frost damaged, cracked or chipped concrete posts
- Panels are built quickly using tongue & groove boards
- Easy to carry & deliver; much lighter than concrete posts
- Recycled, eco-friendly FSC® certified wood
- Wall mounted post / insert available for pre-existing posts



Price per metre run with concrete-in mid / end posts

Birch		Chestnut		Ebony		Twilight Grey	
Fence Height m	Code	Fence Height m	Code	Fence Height m	Code	Fence Height m	Code
1.8	72FP18BM	1.8	72FP18CM	1.8	72FP18EM	1.8	72FP18TGM

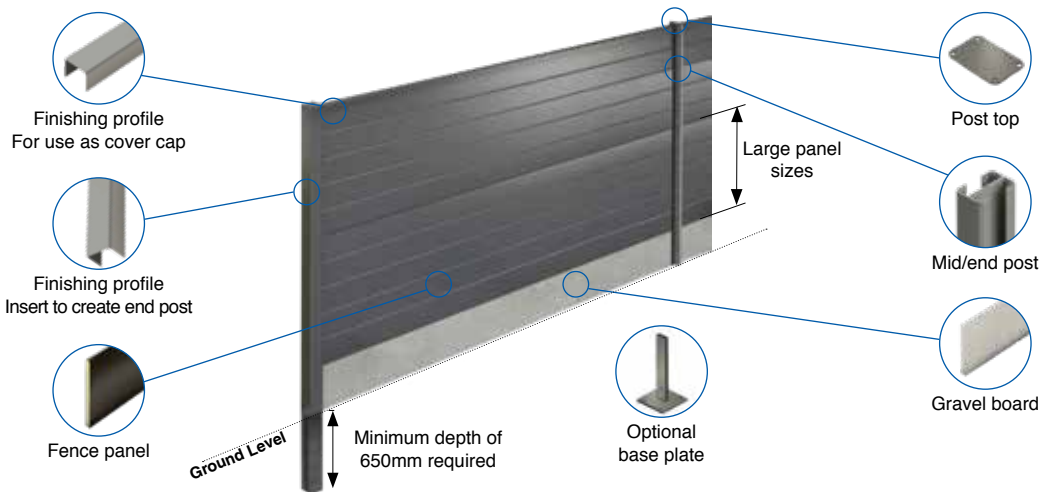
Metre price includes concrete in 1 x mid/end post, 12 x WPC boards and 1 x panel pack. Remember to add any additional corner or end posts required to the order.

Kingspan Fencing



This new to the market, innovative fencing solution from Kingspan offers a high-quality, long lasting, stylish fence. The system is built using the recognised Kingspan sandwich panels, that were traditionally used for cladding buildings and roofs. This lightweight, easy to handle panel only requires posts every 2.5m, meaning far less groundwork is required than alternative composite solutions.

- Aluminium posts, post tops & finishing profile
- Anthracite Deep Matt RAL 7016
- Wind pressure tested to 120km/h
- Polyurethane double-sided panels - smooth one side & ribbed on the other
- Low maintenance, corrosion & UV tested
- Lightweight & quick installation
- Concrete-in or bolt-down options
- Robust durable coating allows panels to be used up to 1km from the coast



Anthracite



End Post



Mid Post



Corner Post



Description	Fence Height m	Metre Code
With Gravel Board	1.8	61S001AM
Without Gravel Board	1.8	61S001AXM

Code	Code	Code
61PCEP18A	61PCMP18A*	61PCCP18A

Concrete-in. To suit a 1.8m fence height. Supplied with post top and finishing profile. *Finishing profile not required.

Includes 3 x 2500 x 488mm fence panels, 1 x mid/end post, 1 x post top with screws, and 1 x finishing profile.

MARANO®
LIGHT • STYLE • VISION

From
£111.00
Per Metre

Aluminium Fencing With Integrated Laser Cut Screens

Our **NEW** aluminium fencing with integrated laser cut screens is an exciting addition to our Marano® product range. Offering long-lasting, lightweight aluminium boards that give total flexibility, this fencing solution can provide either complete privacy or open boards mixed with contemporary laser cut screens to add a decorative feature to the garden. All boards and full height screens can be used in conjunction with each other, making the design possibilities endless.

Endless design possibilities.



Scan here for more
information.



For more information on our
metre rate prices, call
Freephone 0808 3047069

Marano® Aluminium Fencing

Top cap with connect board



Mid post with laser cut screen insert



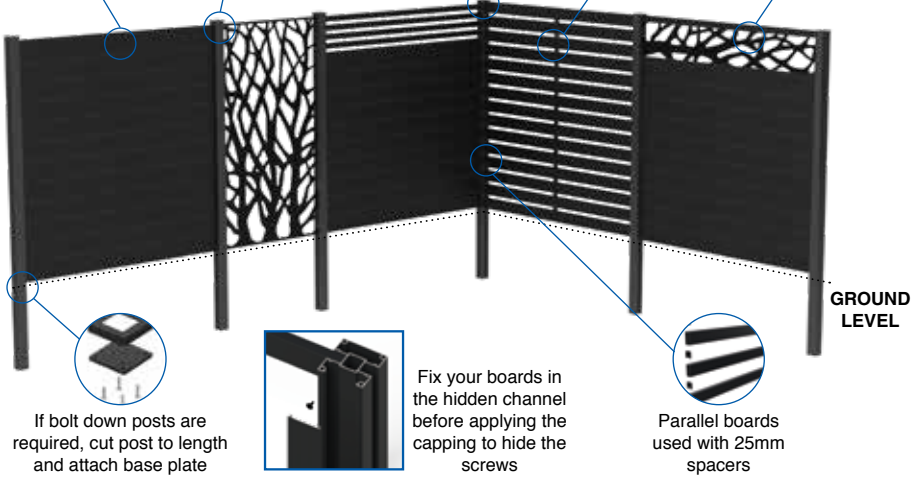
Mid post with corner post insert



Support kit



Screen with fixing kit



If bolt down posts are required, cut post to length and attach base plate



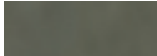
Fix your boards in the hidden channel before applying the capping to hide the screws

Parallel boards used with 25mm spacers

GROUND LEVEL

Boards are available in 4 powder coated matt finish boards, 2 wood effect boards or alternatively a mill finish, to allow you to powder coat to your preferred choice of RAL colour.

Basalt Grey
RAL 7012



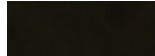
Pebble Grey
RAL 7032



Beige Grey
RAL 7006



Black Sand
RAL 9005



Oak Wood Effect



Grey Wood Effect



Board Styles

Half Round



Parallel 50



Parallel 100



Parallel 150



Louvre



Ridged



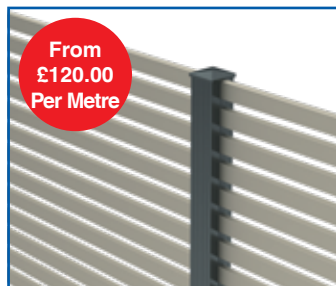
Wave



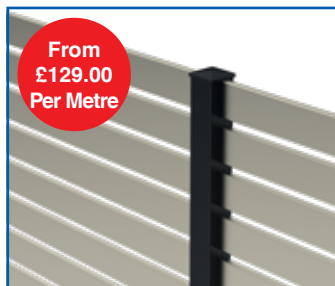
Connect 150



Parallel 50 Board



Parallel 100 Board



Wave Board



Ridged Board



Connect 150 Board



Connect 150 with palm laser Screen



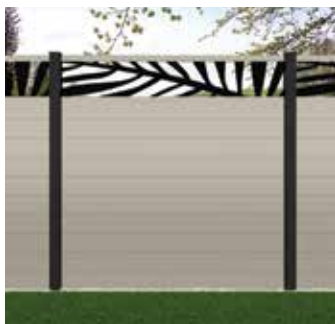
Steel fabricators and gate makers can incorporate these boards into steel gate frames and rely on the extensive F.H. Brundle range of steel sections, gate hardware and automation to create matching gates specific to customers' requirements.

1825 x 300mm Laser cut screens

Sunburst



Palm



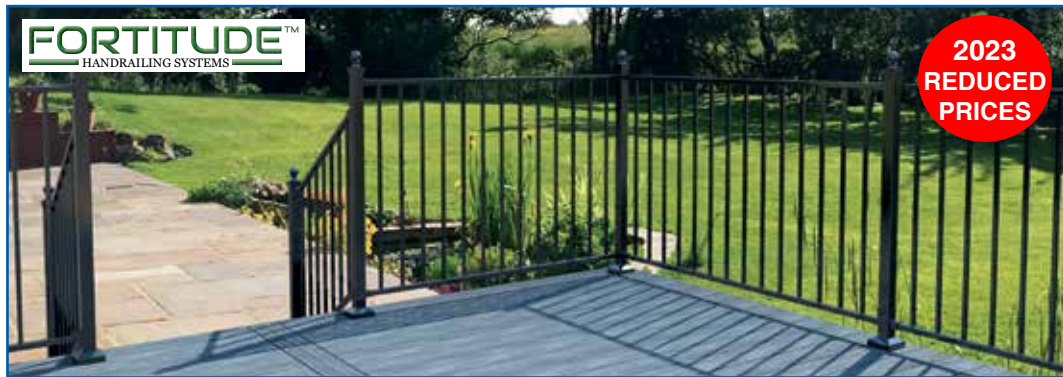
Woodland



For more information on our metre rate prices, call Freephone Freephone 0808 3047069

8 REASONS TO USE FORTITUDE™

Our most flexible handrailing solution, just became more flexible! As we edge into spring, not only are we implementing significant price reductions to our top-quality Fortitude™ handrailing system, we are also pleased to announce even more innovations to enhance the range.



Reason 1 Modular Railing System

This steel railing system brings an unparalleled quality to any patio deck or balcony. Giving a clean classic appearance that offers versatility in any residential application. The modular design allows the installer to complete the project without prior visits to sites, saving time and unnecessary journeys.

FORTITUDE RAILINGS • PURE QUALITY • PREMIUM FINISH



1. Made from pre-galv steel



2. Zinc Phosphate pre-treatment



3. Electro coated



4. Quality powder coated finish



Tested To Relevant British Standards

Build stronger, build stylish, build quicker with Fortitude™. Not your typical steel railing, Fortitude™ is fully tested to BS 6180, which is perfect for residential applications. The panels and brackets are tested to the strict criteria of the British Standards and can be integrated easily with a variety of surfaces and materials.



Bracket For Steel Posts



Bracket For Brick Pillars



Bracket For Wooden Posts



Glass Clamps For Steel Posts

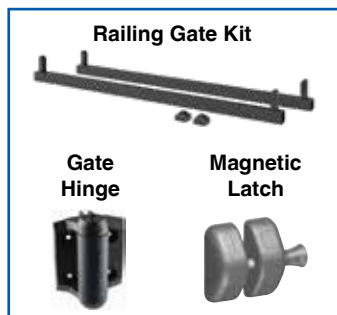
Reason 2 Adjustable Panel

The only UK handrailing system on the market that offers a self-raking panel which can be adjusted on site, to cope with the varying degrees of stairs and gradients that installers come across.



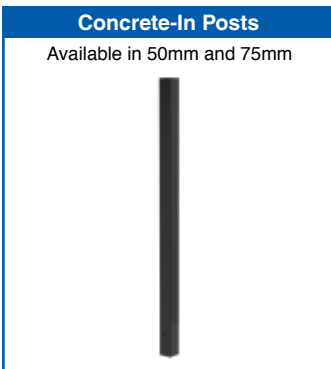
Reason 3 Make An Instant Gate On Site

Using our innovative railing gate kit, simply cutting a standard panel to size, insert the gate side supports and screw together. Then select your long lasting polymer gate hardware with a choice of a self-closing or unsprung hinge.



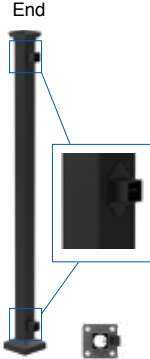
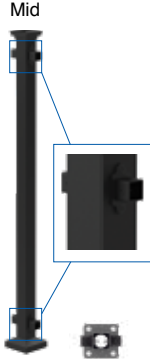
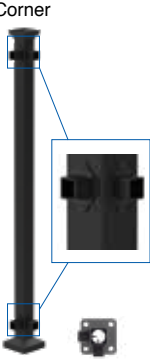


Reason 4 Concrete-In Posts

We now offer concrete-in posts that can be used with self-raking panels. A flexible fencing system for demarcation between gardens or boundaries on slopes and gradients.



Reason 5 Faster Installations


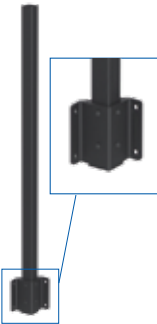

For speed of installation on decking and balconies, we supply pre-drilled posts, ready to take our superior universal bracket and superior horizontal bracket. The brackets screw quickly onto the posts, without the need for on site drilling.

Pre-Drilled Bolt-Down Posts			Superior Universal Bracket
<p>End</p> 	<p>Mid</p> 	<p>Corner</p> 	<p>For use with fixed panels</p> 
			Superior Horizontal Bracket
			<p>For use with fixed panels, 60° left & right</p> 

Reason 6 Fascia-Fix Posts

These unique posts are ideal for decks where you want to maximise the floor area. Our fascia-fix posts are a quick and easy solution, using a combination of internal and external corners, you can install a safe stylish handrailing around any deck.



Fascia-Fix Posts		
<p>End/Mid</p> 	<p>Inside Corner</p> 	<p>Outside Corner</p> 

Choice Of Brackets



Choice Universal Bracket



Superior Stair Bracket



Superior Horizontal Angle Bracket



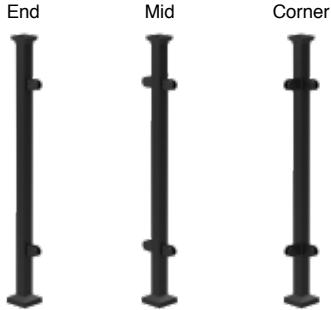
Superior Universal Bracket

Reason 7 Want To Enhance Your View?

Our new range of Fortitude™ Contemplation posts and stocked glass panels, provide installers with a stunning glass balustrading solution....off the shelf. It can also be integrated with our traditional system, if you want a few glass panels to improve the view on a specific section of your installation.

Posts With Glass Clamps

Posts are supplied with glass clamps, cover plates and post caps



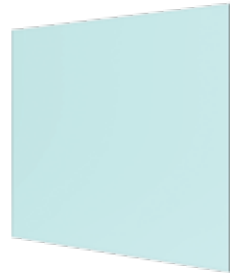
Reason 8 Glass Panels From Stock

The aim of the Fortitude™ range is to offer everything from stock, which will provide installers with an instant handrailing system. We hold large stocks of 10mm thick toughened glass panels in 100mm increments, to give an 1100mm high, stunning handrailing solution.



Glass Panels

As well as our range of stocked sizes we offer very competitive rates on bespoke glass panels



Choice Of Post Caps



Ball Post Caps



Pressed Post Cap



Pyramid Post Cap

Pro-Railing® Frameless Glass Balustrade

Wedge-Loc™ Slim

Base-Fix

Side-Fix



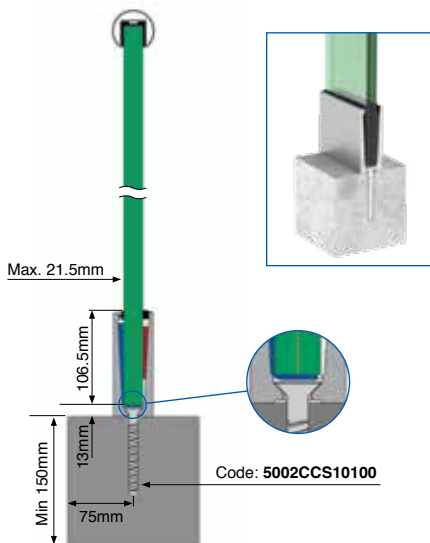
- Available in satin anodised, PPC black & mill finish
- Stainless cladding not required
- Great value
- Quick & easy to install
- Pre-drilled channel fixing holes
- Suitable for 12 - 21.5mm glass



From
£132.00
Per Metre*

*Includes 12mm glass.

Image shows a base-fix application



For more information on our metre rate prices, call Freephone 0808 3047068

Image shows a base-fix application

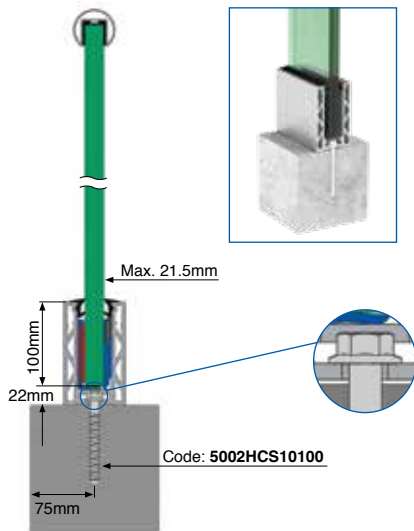
Wedge-Loc™ Duo

Base-Fix

Side-Fix



- Available in satin anodised and PPC black finish
- Stainless cladding not required
- Wedges allow the quick alignment of glass
- Quick & easy to install
- +/- 1° adjustment on glass using the Flexible Hex Bit
- Suitable for 15 - 21.5mm glass

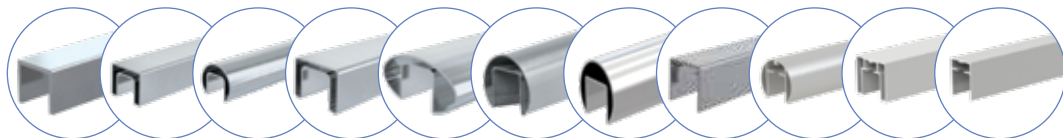


From
£158.00
Per Metre*



*Includes 15mm glass.

Add the perfect finish with one of our many top rails. See page 20.



Wedge-Loc™ F-Type

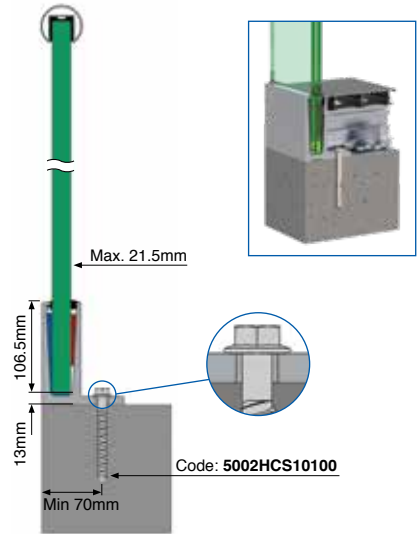
Base-Fix



- Available in satin anodised and PPC black finish
- For balconies, decking subframes & under new screed
- F profile doesn't require counter-sunk anchors for fixing
- Quick & easy to install
- Pre-drilled channel fixing holes
- Suitable for 12 - 21.5mm glass

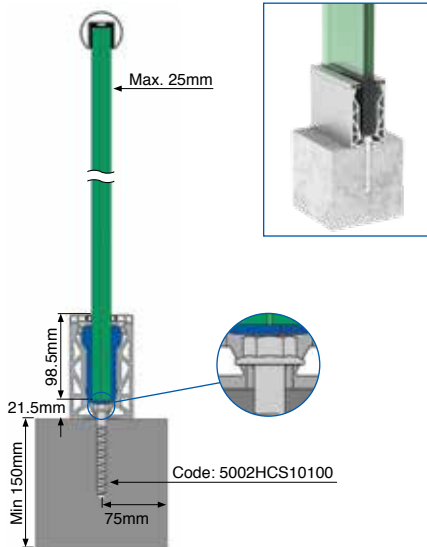


Image shows a base-fix application



For more information on our metre rate prices, call Freephone 0808 3047068

Image shows a base-fix application



POSIglaze

Base-Fix

Side-Fix

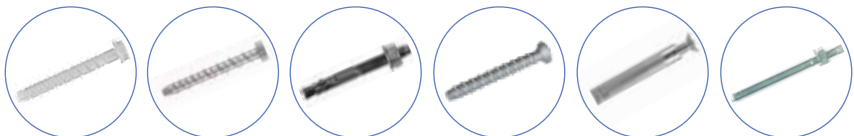


- Available in satin anodised and PPC black finish
- Simply adjust the bolt screw to align the glass
- Quick & easy alignment of glass panels
- Lightweight & extremely strong
- Suitable for domestic & commercial applications
- Suitable for 12 - 21.5mm glass

From
£166.40
Per Metre*



A full range of fixings are available online.



Pro-Railing® Top Rail Systems

PRO-RAILING
The Stainless Steel Handrail Component System

A stylish solution for the top of any glass balustrade.

The largest range of top rails available from stock. Our metre prices include 1 x top rail and 1 x rubber gasket to suit your required glass thickness.

- Systems to suit 8 - 21.50mm glass
- Anodised aluminium, PPC black or stainless steel
- No welding required
- Satin polish or mirror finish
- Choice of 11 profiles including rubber gasket

Square Slim



From
£1.40
Per Metre

Aluminium



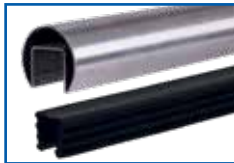
Square Mini



Round Mini



Round



Rectangular



Oval



Round Mirror Finish



Aluminium Round



Aluminium Square



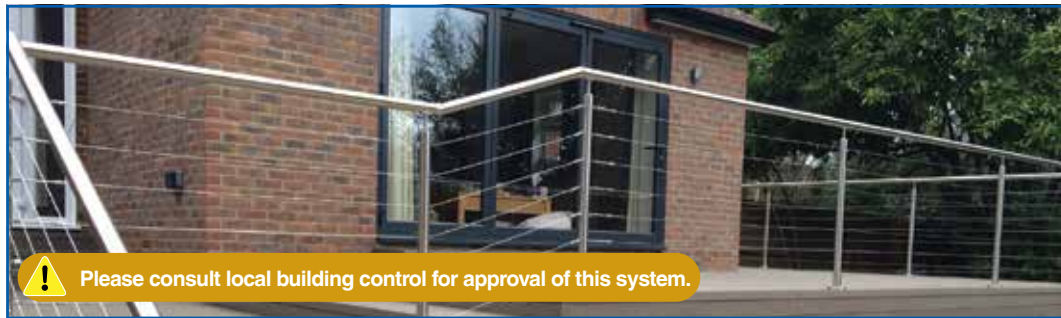
Aluminium Rectangular



Scan here to shop
Top Rails.



For more information on our metre rate prices, call Freephone 0808 3047068



Stainless steel Ø 3 and 6mm strand wire rope system is a simple and cost effective alternative to our crossbar system. It can be fixed to most surfaces including wood, metal and brick and is ideal for external applications in residential and commercial environments. Suitable for self assembly and simple to install using self locking, crimped or glued connectors.

Wire Rope Systems:

System 1 - in-line

System 2 - in-line

System 3 - for flat runs/ stairs

System 4 - for stairs

System 5 - for steps on

maximum 24 or 34° angle

System 6 - for flat runs

System 7 - for wooden posts

System 8 - for wooden posts



Cable Tensioner
For flat runs



To Suit Wire Ø mm	Size mm	Code
3	Flat	1806617
	42.4	1806617C
	48.3	1806617D
6	Flat	1806667
	42.4	1806667C
	48.3	1806667D

Includes 1 x threaded cable tensioner, cover cap and end fitting.

Cable Tensioner
For stairs and slopes



To Suit Wire Ø mm	Size mm	Code
3	Flat	1806618
	42.4	1806618C
	48.3	1806618D
6	Flat	1806677
	42.4	1806677C
	48.3	1806677D

Includes 1 x threaded cable tensioner, cover cap and end fitting.

Cable Tensioner
Through fitting



To Suit Wire Ø mm	Size mm	Code
3	N/A	1806613
6	N/A	1806673

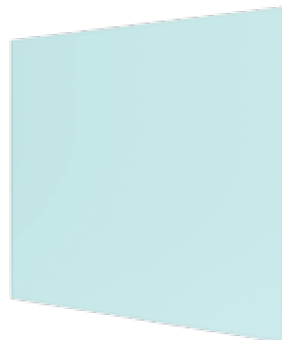
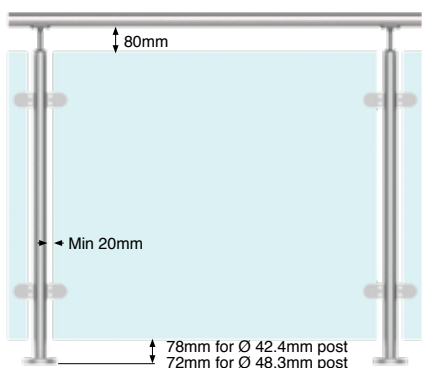
[Scan here to shop Wire Rope.](#)



Pro-Railing® Post & Glass Systems

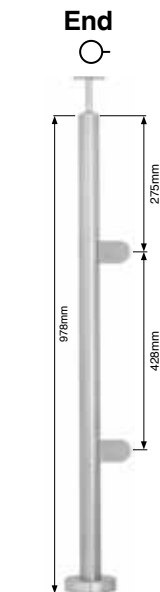


Timeless - For Use With Handrail



Timeless Glass Panels
900mm High 10mm Thick

Width mm	Code
100	185510100900
200	185510200900
300	185510300900
400	185510400900
500	185510500900
600	185510600900
700	185510700900
800	185510800900
900	185510900900
1000	1855101000900
1100	1855101100900



Satin Finish



Ø mm	Code
42.4	1806731C

Ø mm	Code
42.4	1806732C

Ø mm	Code
42.4	1806733C



Ø mm	Length m	Code
42.4	5.8	1806701C

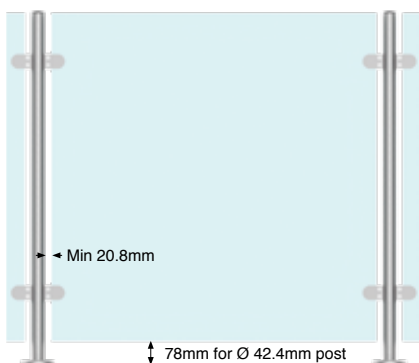
Scan here to shop Timeless.



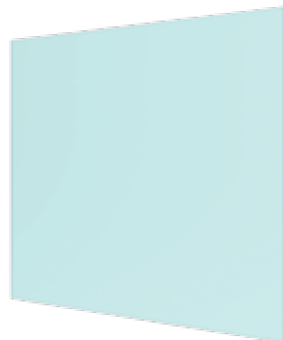
Stainless steel Grade 316. Supplied with glass clamps, cover plate and saddle, to give 1100mm high handrail.



Contemplation - For Use Without Handrail

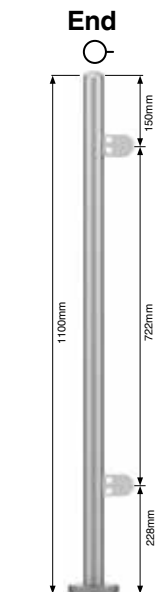


Out the box & ready to install.

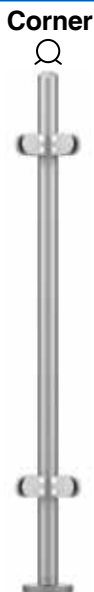


Contemplation Glass Panels
1024mm High 10mm Thick

Width mm	Code
100	1855101001024
200	1855102001024
300	1855103001024
400	1855104001024
500	1855105001024
600	1855106001024
700	1855107001024
800	1855108001024
900	1855109001024
1000	18551010001024
1100	18551011001024



Satin Finish



Ø mm	Code
42.4	1806771C

Ø mm	Code
42.4	1806772C

Ø mm	Code
42.4	1806773C

Stainless steel Grade 316. Supplied with glass clamps, cover plate and end cap, to give 1100mm high handrail.

Bespoke glass panels are also available on request.

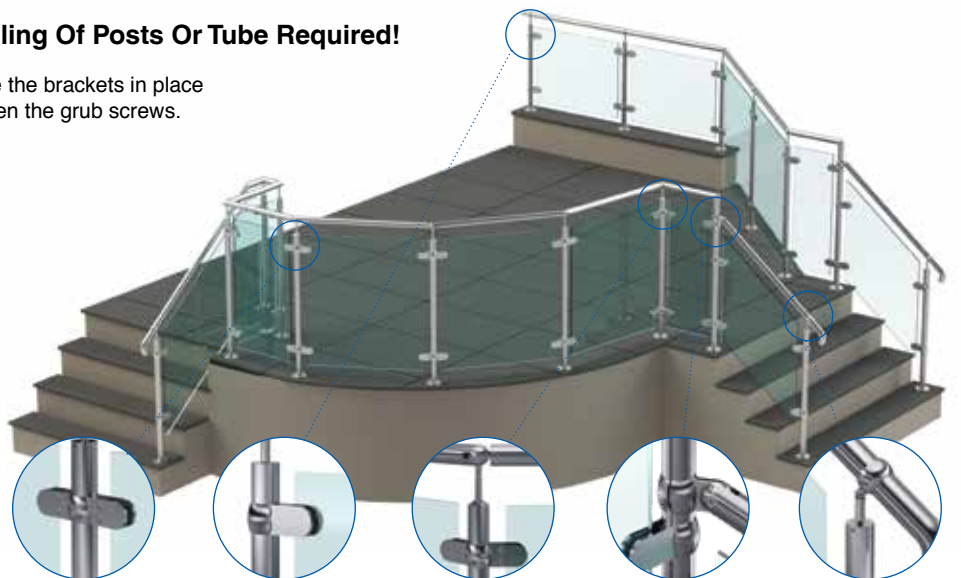
Scan here to shop Contemplation.



Pro-Railing® Sleeve Fit Brackets

No Drilling Of Posts Or Tube Required!

Just slide the brackets in place and tighten the grub screws.



Mid bracket

End bracket

Adjustable corner bracket with adjustable elbow

Adjustable angle bracket

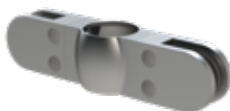
Adjustable handrail support bracket

For stainless Steel Tubes visit www.fhbrundle.co.uk

End Bracket



Mid Bracket



75 - 185° Adjustable Corner Bracket



Glass mm	Ø mm	Code
10	42.4	1806521C10
10	48.3	1806521D10

8 or 12mm rubbers available below.

Glass mm	Ø mm	Code
10	42.4	1806522C10
10	48.3	1806522D10

8 or 12mm rubbers available below.

Glass mm	Ø mm	Code
10	42.4	1806523C10
10	48.3	1806523D10

8 or 12mm rubbers available below.

Adjustable Angle Bracket



Adjustable angle

Ø mm	Code
42.4	1806318CC
48.3	1806318DD

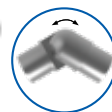
Adjustable Handrail Support Bracket



Adjustable angle

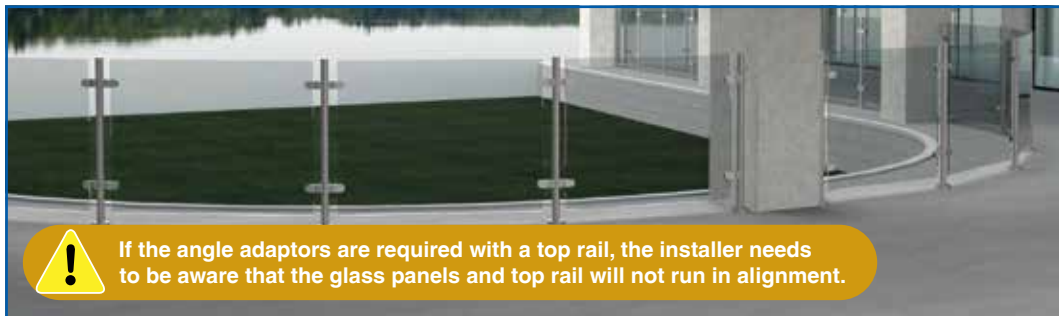
Ø mm	Code
42.4	1806314CC
48.3	1806314DD

Handrail Bracket With +/- 90° Adjustable Elbow



Adjustable angle

Ø mm	Code
42.4	1806314CC
48.3	1806314DD



If the angle adaptors are required with a top rail, the installer needs to be aware that the glass panels and top rail will not run in alignment.

Convert Standard Posts To Adjustable Posts

Using our standard mid or end posts and adding 2 of these angle adaptors to each side of the post, you can create a post that can be adjusted to the required angle at the point of installation.

- Allows for angles +/- 85 degrees
- Minimum radius achievable is 1.5m
- No specialist drilling needed. Mid post can be used to change the angle of a straight run with the addition of the angles

Tube Fix



From
£5.87

Flat Fix



Ø mm	Code
42.4	1806401HC
48.3	1806401HD

Code
1806401HF

Supplied with 1 x M8 bolt.

Supplied with 1 x M8 bolt.

Flat Fix - Fixed to wall

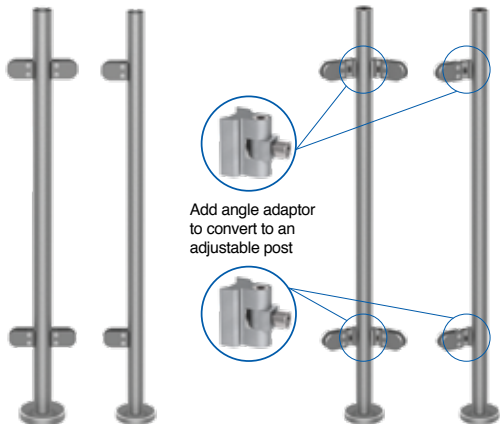


Flat fix angle adaptors are a useful fitting for attaching glass panels to a wall or brick pillar at an angle.

Standard Post



Adjustable Post



Add angle adaptor to convert to an adjustable post

Plan View

Showing adaptors in use with no handrail and Contemplation Posts

Mid Post

Used with a 215 end cap



End Post

Used with a 215 end cap



Plan View

Showing adaptors in use with handrail and Timeless Posts

Mid Post

Used with a 317 adjustable elbow



End Post

Used with a 314 adjustable sleeve



Pro-Railing® Glass Clamps



Satin Finish



Mirror Finish



PPC Matt Black



Flat Back

Glass mm	Ø mm	Code
10	N/A	05CL1260F304
10	N/A	05CL1260F316

Round Back

10	42.4	05CL1260C304
10	48.3	05CL1260D304
10	42.4	05CL1260C316
10	48.3	05CL1260D316

Colour Code:

- Stainless steel Grade 304
- Stainless steel Grade 316
- Aluminium

Flat Back

Glass mm	Ø mm	Code
10	N/A	05CL1260F316

Round Back

10	42.4	05CL1260C316M
10	48.3	05CL1260D316M

[Scan here to shop Glass Clamps.](#)



Flat Back

Glass mm	Ø mm	Code
10	N/A	1805401FB08
10	N/A	1805401FB
12	N/A	1805401FB12

Round Back

8	42.4	1805401CB08
10	42.4	1805401CB
12	42.4	1805401CB12
8	48.3	1805401DB08
10	48.3	1805401DB
12	48.3	1805401DB12

Type 401. Cast aluminium.

Useful Components

Donut cover cap

Fit at time of installation
To suit Ø 42.4 & 48.3mm posts



Retro-fit cover cap

Retro-fitted after installation
To suit Ø 42.4 & 48.3mm posts



Extended scroll end

Complies with part M building regulations. To suit Ø 42.4 & 48.3mm tube. 400mm length



Adjustable internal fit base flange

Ideal for use on stairs & slopes
+/- 55 degree movement



Adjustable angle bracket

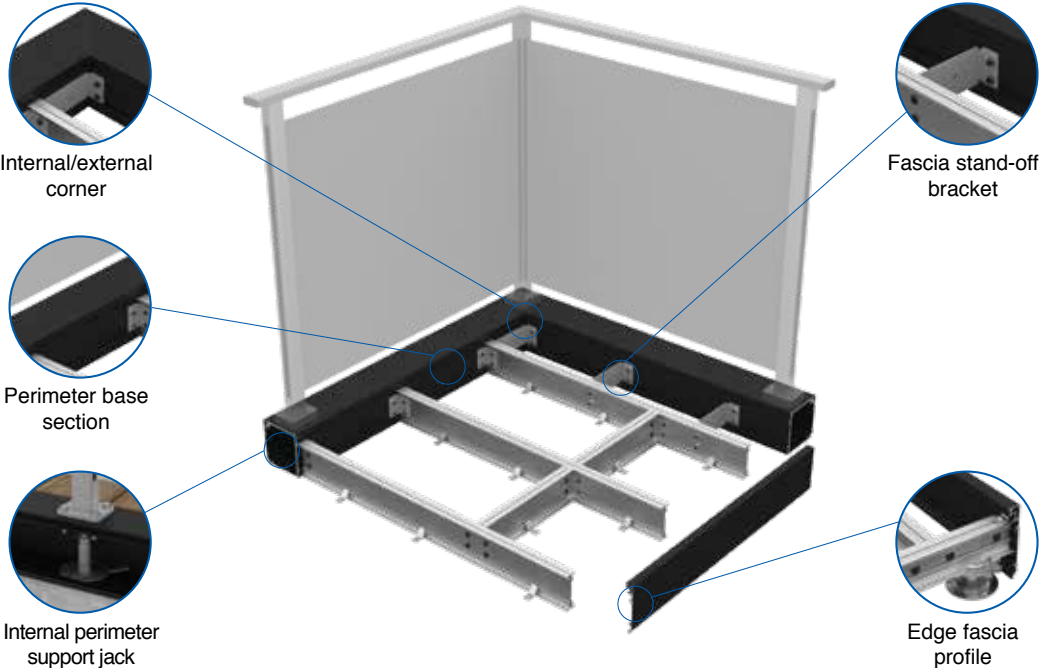
To suit Ø 42.4 & 48.3mm tube.
Locked in place with a grub screw



Synergised™ Perimeter Base System

Our unique innovative Synergised™ perimeter base section, bolts directly to the Synergised subframe. It allows for a wide range of our base fix handrailing solutions to be bolted down to the perimeter, to provide a safe, stunning edge protection where there is a fall of more than 600mm. The internal perimeter support jack provides the strength required to allow handrailing systems to reach the desired residential 0.74kN loading requirements, as per BS 6180.

If handrailing is not required, then our edge fascia profile can be fitted to discreetly hide the subframe. The edge fascia profile is supplied powder coated black, to contrast stylishly with the range of porcelain tiles and handrailing solutions, it also perfectly matches the perimeter base section when used alongside on the same project.



Perimeter Base Section



3600 x 50 x 130mm

79PPB150B **£178.10**

For use with edge fascia profile code: **79EFB100**. Polyester powder coated black RAL 9005.

Edge Fascia Profile



3600 x 100mm

79EFB100 **£40.90**

Polyester powder coated black RAL 9005.

Internal Corner With Fascia



150 x 130mm

79PPBICB **£108.20**

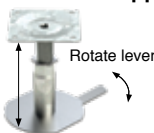
External Corner With Fascia



150 x 130mm

79PPBECB **£114.00**

Internal Perimeter Support Jack



79PBSP01 **£8.10**

Adjust to desired height and rotate lever to lock in place.

Fascia Sand-Off Bracket



79TBC **£7.50**













For use with perimeter base section code: **79PB150B**. Stainless steel.

Rinato™ Composite Deck Boards



With our range of composite deck boards there is a style, colour and price to suit everyone. Boards are easy to install and look fantastic. As well as being environmentally friendly, all our decking is virtually maintenance free, is incredibly durable and will remain so for years to come. Experience the beauty of wood without the hassle.

Features:

- | | | |
|---|---|---|
|  Virtually maintenance free |  Anti-slip resistance tested |  Made from recycled material |
|  Easy to keep clean & stain free |  Easy to install |  Recyclable |
|  Excellent UV resistance |  Workability - similar to wood |  Non-toxic |
|  Splinter free |  Solid & hollow core options |  Flammability tested |





From
£77.50
Per sq/m

Natural Range - Features a 360 degree wrap around Polymer Capstock shield that encapsulates the hollow core deck board and gives it year-round protection against the elements and is suitable for a variety of outdoor uses. Available in 3 colours and with an enhanced natural woodgrain effect one side and traditional flat sanded effect the other.

Cedar Dawn



Platinum Ash



Twilight Grey



Deck Boards - Double-Sided (size: 3600 x 140 x 22mm)



Starter Boards (used at the start of a run to hide starter clips, size: 3600 x 140 x 22mm)



Fascia Boards (size: 3600 x 70 x 10mm)



Grooved L Shaped Trims (size: 3600 x 50 x 50mm)



For a range of clips, see page 31.

Rinato™ Composite Deck Boards



From
£48.00
Per sq/m

Victoria Range - Uses less composite material thanks to the 'M' design on the underside, making the board lighter and more economic, the perfect cost-friendly choice for every garden, balcony or patio. Boards are single-sided with a choice of natural woodgrain effect or a traditional grooved effect across all the colours.

Teak

Redwood

Grey

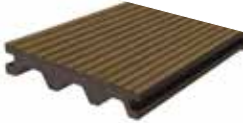
Ebony



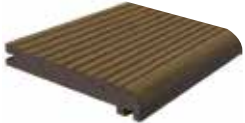
Deck Boards - Single-Sided Woodgrain (size: 3600 x 135 x 23mm)



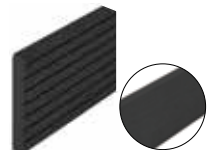
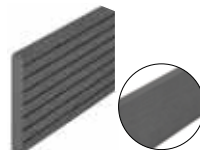
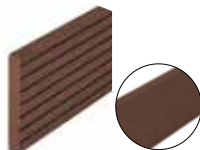
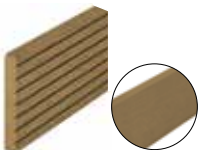
Deck Boards - Single-Sided Grooved (size: 3600 x 135 x 23mm)



Starter Boards (size: 2400 x 168 x 23mm)



Fascia Boards (size: 2400 x 60 x 10mm)



Guide To Fixing Clips



No.	Type	Material	Colour	Gap Between Boards mm	Clips per Pack	Clips Needed per sq/m	Clip Code	Screws Included
1	Starter Clip	Stainless Steel	Silver	0	10	N/A	66SC01	Yes
2	Double Clip	Stainless Steel	Silver	1.5*	50	18	66DC01	Yes
3	Starter Clip	Stainless Steel	Black	7	1	N/A	71SC003	No
	Starter Clip	Stainless Steel	Black	0	25	N/A	71SC003P	No
4	Double Clip	Stainless Steel	Black	7	1	18	71DC003	No
5	Double Clip	Nylon	Black	7	100	18	71DCN003P	No

Screws are supplied in packs of 100, use code: **71SS003**.

*Except Classic boards where the gap is 5mm. For screw driver bit use code: **66TX001**.

NB. We recommend 9 clips per board length when using Natural and Classic boards and 12 clips per board length when using Victoria boards.

We recommend using 10 starter clips per perimeter/starter board across the range.

Aluminium Deck Trims



Our 40 x 40mm profiles cover all deck board thicknesses, the trims will not crack, split, warp or fade and are available in a range of designer RAL colours plus a mill finish to powder coat to a colour of your choice to complement any project.

Oyster White



Serengeti Sand



Umbur Grey



Light Sage



Mineral Grey



Terra Brown



Anthracite



Basalt Grey



Black Sand (non-slip)



Mill Finish



For our most up to date prices visit www.fhbrundle.co.uk

Synergised™ Connected Aluminium Decking System



All elements of the **NEW** Synergised Connected achieve Euroclass Classifications of A2fl-s1. It is manufactured from structural grade 6063 T6 Aluminium, and supplied with a non-slip anthracite RAL 7016 powder coated finish. Its unique interlocking boards allows the system to stay seamlessly connected, whilst offering integrated drainage channels, to direct rainwater away from under the deck. All boards are discreetly and quickly fixed onto the substructure, before fixings are hidden from view, by the next adjoining board.

How To Install Your Deck



Screw down the starter trim.



Connect your first board.



Screw down the deck board.



Connect next board and repeat.



Screw down final board and mitre edging trim.

Features:

- Cost effective, quick & easy to install
- Fully non-combustible. A2fl-s1 fire rated
- No gaps between boards
- Integrated drainage channels
- Made from structural grade 6063 T6 aluminium
- Non-slip design
- Powder coated anthracite RAL 7016
- 10 year warranty on powder coating
- Compatible with Synergised subframe and cradles
- Long lasting & low maintenance
- These sections can be screwed directly onto any subframe or substrate

Board



3600 X 148.95 X 21.60mm

79DB22A

£34.90

Starter Trim



3600 X 148.95 X 21.60mm

79ST22A

£11.20

Edging Trim



3600 x 34.8 x 24.4mm

79ET22A

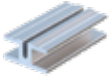
£8.50

Scan here to request a **FREE** sample



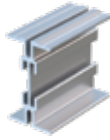
Joists

20mm Profile



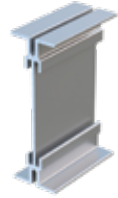
3600 x 40 x 20mm
79J020 **£24.90**

70mm Profile



3600 x 40 x 70mm
79J070 **£37.10**

120mm Profile



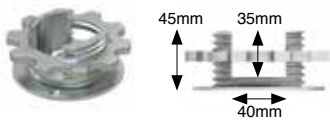
3600 x 40 x 120mm
79J120 **£46.20**

Scan here to request a FREE joist sample



Adjustable Cradles

45mm



79PED45 **£6.20**

64mm



79PED64 **£7.00**

Minimum height 45mm. Maximum height 160mm.

Minimum height 45mm. Maximum height 160mm.



Visit www.fhbrundle.co.uk to download a copy of our installation guide.

Adjustable Pedestals

50 - 75mm



79PED50

75 - 115mm



79PED75

110 - 185mm



79PED110

185 - 260mm



79PED185

250 - 325mm



79PE2D50

Adjustable pedestals are made from zinc passivated steel - zintec 200.



Square Subframe



3600 x 50 x 50mm
7401505036B **£15.40**

Rectangular Subframe



3600 x 50 x 95mm
7401955036B **£31.90**

3600 x 50 x 140mm
74011405036B **£39.90**

Other sizes & colours are available online.



Our WPC cladding boards utilise the same advanced co-extrusion technology as our Natural range of deck boards. The cladding looks completely natural, is low maintenance and easy to clean, unlike timber cladding. The boards are UV resistant and will not fade, keeping their stylish colours for years to come. It is important to allow for the expansion and contraction of the boards in different temperatures. We recommend that batons are used to support the cladding every 500mm.

Features:

- Available in 3 colours
- Contemporary embossed wood effect boards
- Boards are UV resistant and will not fade
- Made from eco-friendly FSC® certified wood
- Boards can be installed vertically or horizontally, using our clever hidden fixing system
- Full range of trims to allow for the system to be installed on any wall

Antique



L x H x T mm	Code
3600 x 140 x 13	73A001

Charcoal



L x H x T mm	Code
3600 x 140 x 13	73CH001

Walnut



L x H x T mm	Code
3600 x 140 x 13	73W001

In-Line Joint Trim



Colour	Code
Antique	73A002
Charcoal	73CH002
Walnut	73W002

H: 3600 x W:79 x D: 26mm

Cladding End Trim



Colour	Code
Antique	73A003
Charcoal	73CH003
Walnut	73W003

H: 3600 x W:47 x D: 45mm

Cladding Angle Trim



Colour	Code
Antique	73A004
Charcoal	73CH004
Walnut	73W004

H: 3600 x W:55 x D: 55mm

Finishing Board



Colour	Code
Antique	73A005
Charcoal	73CH005
Walnut	73W005

H: 3600 x W 70: x D: 10mm



liveconfigurator™

**FREE TO
USE DESIGN
SOFTWARE**

Design, configure, and purchase
custom products with ease

Software that will produce accurate CAD drawings and 3D models for any of these projects

Balustrades

Stairways

Bespoke Glass

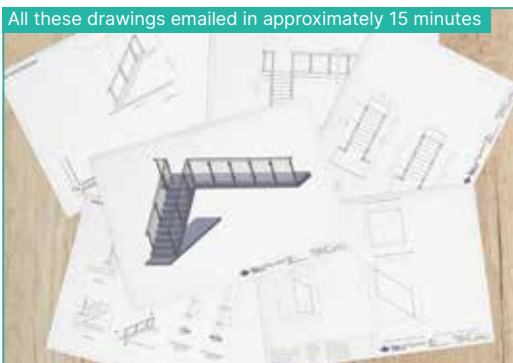
Decking



Configure your design online



All these drawings emailed in approximately 15 minutes



The perfect **FREE** tool for everyone.

Come and have a look and start designing your project.

www.liveconfigurator.co.uk

info@liveconfigurator.co.uk



F.H. BRUNDLE

SERVING THE TRADE SINCE 1889



Dunivaig Road
Queenslie Ind. Est.
Queenslie
Glasgow
G33 4TP

Tel: 0141 773 6699
Fax: 0141 773 6633

Unit B
Spectrum 23
Sankey Valley Ind. Est.
Newton-le-Willows
WA12 8DN

Tel: 01942 86 88 88
Fax: 01942 86 88 99

Middlemore Ind. Est.
Middlemore Road
Smethwick
Birmingham
B66 2EP

Tel: 0121 565 8282
Fax: 0121 565 8292

COMING SOON
F.H. Brundle Cardiff
Alexandra Industrial Est.
Wentloog Road
Rumney
Cardiff
CF3 1EY

**NATIONWIDE
SERVICE**



Condor Road
Quarry Hill Ind. Est.
Ilkeston
Derbyshire
DE7 4RE

Tel: 0115 930 2070
Fax: 0115 951 2455

Lamson Road
Ferry Lane North
Rainham
Essex
RM13 9YY

Tel: 01708 25 35 45
Fax: 01708 25 35 50

502 Millbrook Road
Third Avenue
Millbrook
Southampton
Hants SO15 0JX

Tel: 023 8070 3333
Fax: 023 8070 5555



Wrought Iron
Components



Perforated
Metal



Expanded
Metal



Welded
Wire Mesh



Woven
Wire Mesh



Gate
Hardware



Gate
Automation



Flooring &
Stair Treads



Steel
Section



Sliding Door
Gear



Handrailing &
Components



Fixings &
Tools



Tube
Clamps



Crash
Barrier



Gates &
Railings



Fencing &
Security



Cantilever Gate
Components



Working at
Height

Whilst every effort has been made to ensure the accuracy of the information supplied, F.H. Brundle cannot be held responsible for any errors or omissions. The Company reserves the right to withdraw the promotion at any time without notice. Valid until 30/06/2023.