



# F.H. BRUNDLE

SERVING THE TRADE SINCE 1889



Frameless Glass Balustrade



Wrought Iron Components



Gate Hardware

## CHECK OUT OUR FEBRUARY OFFERS



Anti-Scaling Barrier



Tube Clamps



Mesh Fencing Systems



Steel Sections



# liveconfigurator™



Most Innovative Interior  
Design Software 2023

**FREE TO  
USE DESIGN  
SOFTWARE**

## Design, configure, and purchase custom products with ease

Software that will produce accurate CAD drawings and 3D models for any of these projects

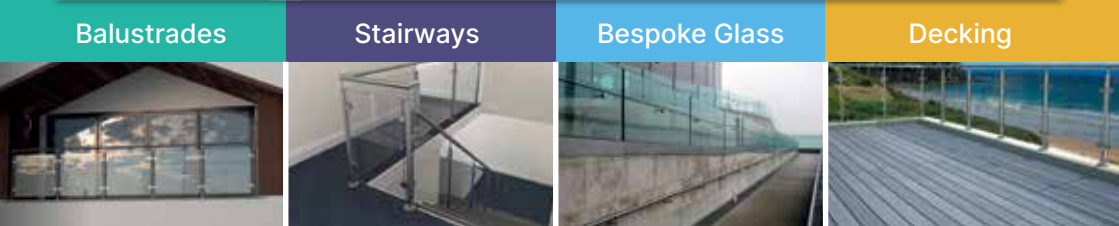

Configure your design online



All these drawings emailed in approximately 15 minutes



The perfect **FREE** tool for everyone.

Come and have a look and start designing your project.

[www.liveconfigurator.co.uk](http://www.liveconfigurator.co.uk)

[info@liveconfigurator.co.uk](mailto:info@liveconfigurator.co.uk)



# OUR NEW WEBSITE HAS NOW LAUNCHED!



Here are just some of the new key features you can expect to find:

- Improved predictive search facility
- Find your exact requirements using the product filters
- Click and collect from our nationwide network of branches
- See what other customers are buying with the products you select
- Share and view baskets with colleagues and customers via email
- View the components and quantities used to build our metre rates
- Guidance metre prices on our range of handrailing systems
- Receive accurate delivery dates and stock availability when viewing your basket
- View CAD drawings, technical information and so much more....

[www.fhbrundle.co.uk](http://www.fhbrundle.co.uk)

# Steel Sections

As one of the UK's leading steel sections stockholders, F.H.Brundle is your go-to source for high-quality steel products for light steel construction applications. With a comprehensive range of square, flat, angle, and hollow sections, as well as round steel bars, universal steel columns and beams, channels, sheets, and plates, we have everything you need to complete your project. With our quick and competitive cut-to-size service, you can get exactly the sizes you need to fit your specifications.

## Columns, Beams & Channels

**Universal Column**



**Universal Beam**



**Channel**



**Rectangular Hollow**



## Hollow Sections

**Square Hollow**



**Circular Hollow**



**Flat Bar**



## Merchant Bar

**Square Bar**



**Round Bar**



**Half Round**



## Decorative Bar & Galvanised Tube

**Convex**



**Galvanised Tube**



**CR4 Sheet**



## Sheets & Plates

**Galvanised Sheet**

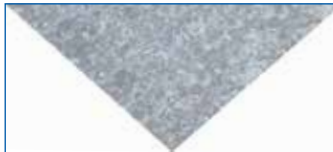

**Hot Rolled Plate**



At F.H.Brundle, we take pride in the quality of our products. All of our steel products are grade S355, S275, and 500B, which means they are strong, durable, and able to withstand the demands of even the toughest construction projects. Plus, with our test certificates available on request, you can trust that our products meet the highest standards. Whether you're working on a large-scale construction project or a small-scale DIY project, F.H.Brundle has the steel products you need to get the job done right.

## Rolled Steel Angles

### Unequal Angles



### Equal Angles



### T Sections



### ERW Rectangular Hollow



## ERW Hollow Sections

### ERW Square Hollow



### ERW Circular Hollow



## Hammered & Twisted Bar

### Hammered Box



### Hammered Bar



### Twisted Bar



## Punched Bar, Rebar & Threaded Rod

### Punched Bar



### Rebar



### Threaded Rod



## Durbar, Chequer Plate & Steel Plates

### Durbar



### Chequer Plate

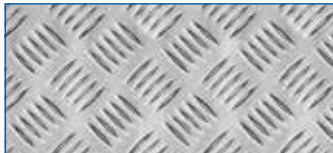

### Steel Plates



## Welded Wire Mesh

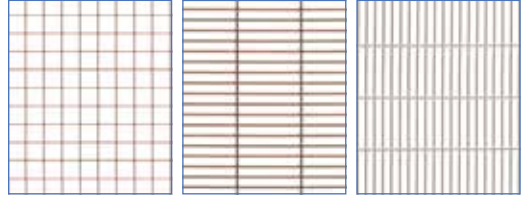

- Over 180 specifications in stock
- Standard sheets or rolls
- Bespoke mesh made to your requirements

- Mild steel, stainless steel Grade 304 & 316
- Cut to size on request
- Galvanised, pre-galvanised, PVC coated & PPC black

### Pre-Galvanised Sheet

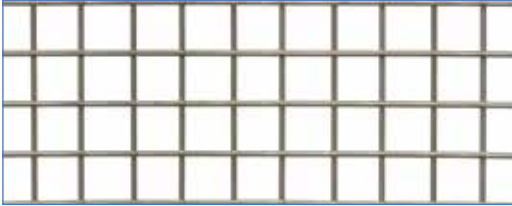

### PPC Sheet Black RAL 9005

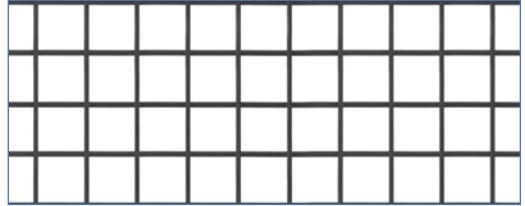

The widest range of mesh clips from stock in the UK all at great prices!



From only £0.26

**FREEPHONE 0808 303 4690 to speak to a sales advisor!**

## Perforated Metal

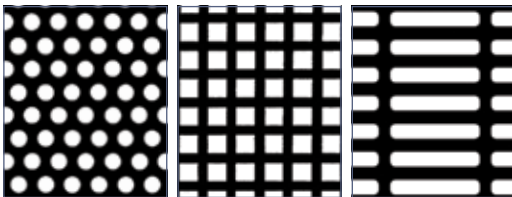

- Over 150 specifications in stock
- Round, square or slotted holes
- Diagonal or square pitch
- Decorative sheets

Huge Stocks

- Mild steel, stainless steel Grade 304 & 316, aluminium & zinc
- Cut to size or framed on request
- Galvanised & pre-galvanised

## Expanded Metal

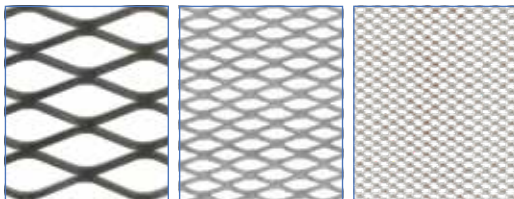

- Over 80 specifications in stock
- Raised, flattened or shaped
- Riblath & brick reinforcement

- Mild steel, stainless steel Grade 304 & 316 & aluminium
- Cut to size or framed on request
- Galvanised, pre-galvanised, PPC green

## Woven Wire Mesh

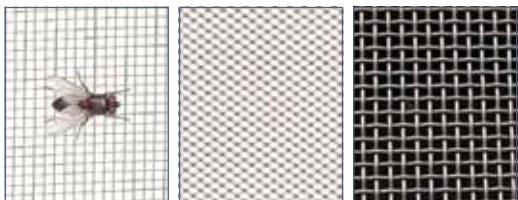

- Over 35 specifications in stock
- Plain or hollander weave
- Insect & soffit vent mesh

- Mild steel, stainless steel Grade 304 & 316, brass, copper, aluminium & fibreglass
- Cut to size or framed on request

Visit [www.fhbrundle.co.uk](http://www.fhbrundle.co.uk) now for...

### Framed Infill Panels



Quick and easy to install, mesh infill panels help provide extra security in a handrail, balustrade or guardrail. We provide a range of mesh infill panels, and safety mesh for railings. Our galvanised single and double infill panels fit the 1.2m and 1.5m post centres of our pre-assembled Tube Clamp posts, and also our post protectors.

Gabions offer the most cost-effective and rapidly deployed solution for retaining wall systems. They are used in a huge range of situations including landscaping, to stabilising earth movement and canal refurbishment, all while achieving a robust yet natural look.

### Flat Pack Gabions



### Profiled & 'U' Edging Sections



Edging and Framing Sections are suitable for framing welded mesh, perforated and expanded metal sheets. They're an excellent way of fixing and protecting sheets of metal, as well as making them easier and safer to handle.

# Wrought Iron Components



## Primers

### High Build Red Oxide



Available In Litres	From
2.5, 5 & 20	<b>£9.10</b>

### **NEW** Black Primer



Available In Litres	From
2.5, 5 & 20	<b>£9.00</b>

### Galvalast Grey



ml	Code	Price
500	<b>2903</b>	<b>£12.20</b>

Thinner code: **29WS05**. Best for rollers and brushes.

### Gloss Smithy Black RAL 9005



Code	Price
<b>29RGB01</b>	<b>£14.80</b>

Tin size: 1lt.

### Semi Gloss Smithy Black RAL 9005



Code	Price
<b>29RSB01</b>	<b>£10.50</b>

Tin size: 1lt.

### Black Hammered finish



Code	Price
<b>29H1B</b>	<b>£13.10</b>

Tin size: 1lt.

### Bright Cold Zinc Galvanise Spray



Code	Price
<b>2902A</b>	<b>£8.90</b>

Can size: 500ml.

## Railheads



H x W mm	Base mm	Code	Price
120 x 70	■ 20	<b>05137279</b>	<b>£0.66</b>



H x W mm	Base mm	Code	Price
125 x 10	● 18	<b>0513096</b>	<b>£0.80</b>



H x W mm	Base mm	Code	Price
130 x 60	● 12	<b>0513052</b>	<b>£0.25</b>

## Stainless Steel Numerals

- 100mm high
- 1.5mm thick



Our 3M self-adhesive numerals are ideal for use on front doors, steel gate posts and post boxes.



## Circles



Ø mm	Code	Price
100	0535331042	£0.50

Bar ■ 12 x 6mm. Sandblasted.



Ø mm	Code	Price
100	0502016	£0.90

Bar ■ 12mm.



Ø mm	Code	Price
100	0502007	£0.78

Bar ● 12mm.

## C Scrolls



H x W mm	Code	Price
100 x 60	050108605	£0.93

Bar ■ 12 x 6mm



H x W mm	Code	Price
135 x 75	0501009	£0.90

Bar ■ 12 x 6mm

## Baskets



H x W mm	Code	Price
150 x 65	0502080	£1.30

Made from 4 x ■ 6mm bar

## S Scrolls



H x W mm	Code	Price
200 x 100	0500520042	£0.97

Bar ■ 12 x 6mm



H x W mm	Code	Price
250 x 100	0544920042	£1.50

Bar ■ 12 x 6mm

## Bushes



H x W mm	Code	Price
67 x 40	0513142	£1.00

Bar ■ 12 x 6mm

## Infills



Ø mm	Bar mm	Code	Price
100	■ 12 x 6	0508910042	£1.00



Ø mm	Bar mm	Code	Price
100	■ 12 x 6	0598088042	£0.86



Ø mm	Bar mm	Code	Price
100	■ 12	0530810024	£1.30

## Make Your Own Fire Pits Or Fire Balls



Ø mm	Code	Price
500	0513251500B	£53.20
700	0513251700B	£113.00
900	0513251900B	£191.20



Ø mm	Code	Price
500	0513251500H	£68.70
700	0513251700H	£150.30
900	0513251900H	£284.30



# Wrought Iron Components

## Punched Bars

**Flat Bar With Square Holes**  
18 holes, 100mm gaps



From  
£16.00  
Each

To Suit mm	Bar mm	Code
■ 12	30 x 10 x 2134	050806001A
■ 16	40 x 10 x 2206	050807007A
■ 20	50 x 10 x 2278	050807008A

**Flat Bar With Round Holes**  
18 holes, 100mm gaps



From  
£14.00  
Each

To Suit mm	Bar mm	Code
● 12	30 x 10 x 2134	050807201A
● 12	40 x 10 x 2134	050890101A
● 16	40 x 10 x 2206	050808207A
● 16	50 x 10 x 2206	050890207A
● 20	50 x 10 x 2278	050808208A

## Bowed Balusters & Bars For Railings



Size mm	950 x 200
Code	050410605
Price	£4.30

Smooth.  
Bar ■ 12mm.

Size mm	950 x 200
Code	0504103
Price	£3.60

Hammered.  
Bar ■ 12mm.



H mm	900
Code	0505901
Price	£4.00

To give 100mm gap.  
Bar ● 12mm.



H mm	900
Code	05181324209
Price	£2.80

Smooth. 25mm sphere.  
Bar ● 12mm.



H mm	1130
Code	0518130521
Price	£2.70

Smooth.  
Bar ● 12mm.

## Spheres

**Hollow Steel Spheres**



Ø mm	Code	Price
40	051325140	£0.70
50	051325150	£0.90
60	051325160	£1.30
70	051325170	£2.00
80	051325180	£2.80
90	051325190	£3.80

2.5mm thickness.

**Solid Steel Spheres**



Ø mm	Code	Price
20	0513241	£0.24
25	0513242	£0.27
30	0513243	£0.37
35	0513244	£0.50
40	0513245	£0.69
50	0513246	£1.10

**Solid Steel Forged Spheres**



Ø mm	Code	Price
50	0505003004	£2.30

**LUG**



H x W x T mm	Code	Price
40 x 60 x 10	05LUG4	£0.78

**FREEPHONE 0808 303 4690**  
to speak to a sales advisor!

## Bars & Box Sections

Twisted Bar



Length m	Bar mm	Code	Price
3	12	0512146	£7.60
3	16	0512148	£18.10
6	12	0512158	£17.10
6	16	0512160	£30.10

Convex Bar



Bar mm	Code	Price
38 x 13	30133813	£61.70
51 x 13	30135113	£79.90

Length 6m.

Hammered Box



Size mm	Code	Price
20 x 20 x 2.0	0512244	£19.60
25 x 25 x 2.5	0512242	£26.30
30 x 30 x 2.5	0512240	£35.30
40 x 40 x 2.5	0512238	£47.70
50 x 50 x 2.5	0512236	£63.60

Length 6m.

## Post Caps

Square Cap With Flange

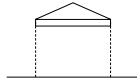

To Suit mm	Code	Price
30	0515052	£0.36
40	0515053	£0.55
50	0515054	£0.56
60	0515055	£0.62
70	051505570	£0.61

To Suit mm	Code	Price
80	0515056	£1.00
100	0515057	£1.10
120	0515058	£2.40
150	0515059	£3.20

Hollow Cap



To Suit mm	Sphere Ø mm	Code	Price
30	40	051505905	£2.00
40	40	051505906	£2.10
50	50	051505907	£2.50
60	60	051505908	£3.20
80	80	051505909	£6.30
100	80	0540604000	£5.20
100	100	051505910	£7.90

## Gate Hardware

Adjustable Gate Eyes

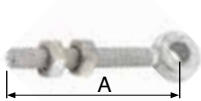

From  
£1.30  
Each

To Suit Pin Ø mm	A mm	BZP Code
12	M12 x 115	0700124
16	M16 x 119	0700164
20	M20 x 165	0700206

To Suit Pin Ø mm	A mm	Galvanised Code
12	M12 x 115	0702124
16	M16 x 119	0702164
20	M20 x 165	0702206

Weld-On Gate Hooks



From  
£0.90  
Each

To Suit Ø mm	Size mm	Code
12	30 x 40 x 12	071012
16	40 x 60 x 15	071016
20	45 x 60 x 10	071019

Weld-On Gate Eyes



From  
£1.50  
Each

Pin Ø mm	Size Of Flat Section mm	Code
12	30 x 40 x 12	072012
16	40 x 60 x 15	072016
20	40 x 60 x 20	072019

Decorative Gate Hinge



Only  
£4.30  
Each

Code
070212

M12 thread.

Security Collars



From  
£0.80  
Each

To Suit Pin Ø mm	BZP Code
12	073012
16	073016
20	073019



**LOCINOX**  
Let's make it better together

## Hinges

### Locinox Adjustable Hinge

With adjustable welding nut

- 90° opening
- Available for gates up to 300kg
- Zinc plated adjustable nut
- Hot-dipped galvanised
- Captive washer for easy adjustment



Code	From
0515GBM30	£5.50

### Locinox Adjustable Hinge

With adjustable steel wall plate & adjustable nut

- 90° opening
- Available for gates up to 300kg
- Zinc plated adjustable nut
- Self colour ear plate for welding
- Hot-dipped galvanised
- Captive washer for easy adjustment



Code	From
0515GBM40	£7.00

### Locinox Strap Hinge Set

With captive washer

- Self colour weld-in base
- Available for gates up to 150kg
- Zinc plated adjustable nut
- Hot-dipped galvanised clamp hinge with stainless steel bolt
- Connection bolt
- Captive washer for easy adjustment



Code	From
0515GBM50	£10.50

### Locinox Hinge Set

With wall plate

- Self colour weld-in base
- Available for gates up to 300kg
- Hot-dipped galvanised clamp hinge with stainless steel bolt
- Connection bolt



Code	From
0515GBM60	£14.00

### Locinox 3 Way Adjustable Hinge

- 180° hinge for metal & aluminium gates
- Hot-dipped galvanised arm
- Reversible for left/right swinging gates
- Adjustable height & vertical alignment
- Quick-fix



Code	Price
0515GBM35	£27.00

### Locinox Quick-Fix Mounting Bolt (Patented)

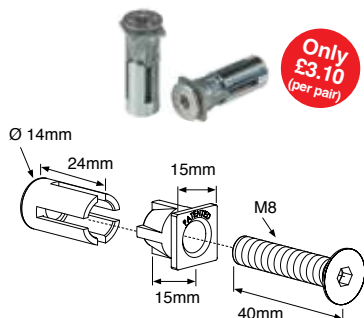

**Discounts available  
for larger quantities!**



## Gate Closers

**Gatemaster  
Gas Gate Closer**



Max. Gate Size H x W m	Max. Gate Weight kg	Code
2.5 x 1.2	80	05GC03B
<b>From £107.00</b>		

**Locinox  
Samson 2**



Max. Gate Width m	Max. Gate Weight kg	Code
2	150	05GC06
<b>From £241.00</b>		

**Locinox  
Verticlose 2**



Max. Gate Width m	Max. Gate Weight kg	Code
1.5	150	05GC19
<b>From £276.00</b>		

Weld-fix.

For our full range of gate hardware, visit [www.fhbrundle.co.uk](http://www.fhbrundle.co.uk)

## Gate Locks

**Gatemaster  
Digital Lock**

Combination keypad on one side



Image shows left hand opening  
lock code: **05SGCH30L**

- Left or right hand opening
- To suit flat bar & up to 30mm box section or 40 - 60mm box section

**BORG  
Digital Lock**

Combination keypad on both side



Image shows lock code: **05B3430**

- Easily reversible handling on site
- Suits gate profiles 30 - 60mm on standard fixings

**Locinox  
Standard Lockcase**

To suit solid and box sections



Image shows lock code: **05LS10**

- Available in black, silver or green
- To suit 10 - 30mm solid section, 30 - 50 or 40 - 60mm box section



A sturdy range of ready-to-install railings and gates with a choice of railheads that are built to last. Our metre rate codes are supplied with 1 x panel, 1 x mid post, cleats and fixings. Remember to order an extra post to finish a run.

- Designed for peace of mind
- Bolt-down or concrete-in
- Matching single & double leaf gates available
- Fence heights from 0.9 - 1.8m

## Fleur De Lis



From  
£71.00  
Per Metre

Description	Fence Height m	Metre Code
Galvanised	1.2	51RTC1212M
Powder Coated Black	1.2	51RTC1212BM

Codes are for a concrete-in post system.

## Vertical Bar



1.2m from  
£54.00  
Per Metre

Description	Fence Height m	Metre Code
Galvanised	0.5	51WVBC1254M
	0.9	51VBC0912M
	1.2	51VBC1212M
Powder Coated Black	0.5	51WVBC1254BM
	0.9	51VBC0912BM
	1.2	51VBC1212BM

Codes are for a concrete-in post system.

## Forest



1.2m from  
£71.00  
Per Metre

Description	Fence Height m	Metre Code
Galvanised	0.5	51WCTC1254M
	1.2	51CTC1212M
Powder Coated Black	0.5	51WCTC1254BM
	1.2	51CTC1212BM

Codes are for a concrete-in post system.



## ROSPA Bow Top Fencing



1.2m from  
£57.00  
Per Metre

Description	Fence Height m	Metre Code
Galvanised	1.0	51RBTC1012M
	1.2	51RBTC1212M
Powder Coated Black	1.0	51RBTC1012BM
	1.2	51RBTC1212BM

Codes are for a concrete-in post system.

## Bow Top



1.2m from  
£52.00  
Per Metre

Description	Fence Height m	Metre Code
Galvanised	0.5	51WBTC1254M
	0.9	51BTC0912M
	1.2	51BTC1212M
	1.5	51BTC1516M
	1.8	51BTC1816M
	1.8	51BTC1820M
Powder Coated Black	0.5	51WBTC1254BM
	0.9	51BTC0912BM
	1.2	51BTC1212BM
	1.5	51BTC1516BM
	1.8	51BTC1816BM
	1.8	51BTC1820BM

Codes are for a concrete-in post system.

## Sphere Top

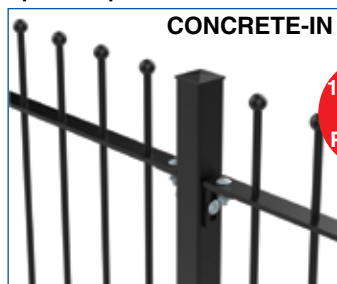

1.2m from  
£71.00  
Per Metre

Description	Fence Height m	Metre Code
Galvanised	0.5	51WSTC1254M
	0.9	51STC0912M
	1.2	51STC1212M
Powder Coated Black	0.5	51WSTC1254BM
	0.9	51STC0912BM
	1.2	51STC1212BM

Codes are for a concrete-in post system.

# Estate Fencing



## Estate Fencing

### SPIKE-FIX



1m from  
£21.00  
Per Metre

Description	Fence Height m	Metre Code
Galvanised	1.0	65FPS09M
	1.2	55FP12M
Powder Coated Black	1.0	65FPS09BM
	1.2	55FP12BM

Codes are for a spike-fix post system.

# Aluminium Railings



## Simplicity Aluminium Railings



1m from  
£31.00  
Per Metre

Post	Fence Height m	Metre Code
Bolt-down	1.0	59RP10BM
	1.2	59RP11BM
Concrete-in	1.0	59RP10CBM
	1.2	59RP11CBM





## Betafence Nylofor® 3M



1.7m from  
£24.50  
Per Metre

Fence Height m	Powder Coated Black Metre Code	PVC Green Metre Code
1.7	56NY3M18BM	56NY3M18GM
2.0	56NY3M20BM	56NY3M20GM
2.4	56NY3M24BM	56NY3M24GM

- Mesh size: 200 x 50mm
- Posts: Twilfix® 2000 system
- Post centres: At approximately 3.025m
- Finish: Powder coated green or black on a pre-galvanised wire

## MeshMaster™ Safe Top



1.2m from  
£35.00  
Per Metre

Fence Height m	Powder Coated Black Metre Code	PPC Green Metre Code
1.2	54ST12BM	54ST12GM
1.5	54ST15BM	54ST15GM
1.8	54ST18BM	54ST18GM

- Mesh size: 150 x 50mm
- Posts: Twilfix® 2000 system
- Post centres: At approximately 3.025m
- Finish: Powder coated green or black on a pre-galvanised wire

## Privacy Fencing Roll

- Privacy for residential properties, terraces & balconies
- Protection against adverse weather
- Helps reduce unwanted noise from outside the property
- UV resistant



Colour	Height mm	Linear Length m	Code
Green	190	50	54PFR190G
Black	190	50	54PFR190B

Can be used with 3M, 3D & 2D.



# Mesh Fencing

## Betafence Nylofor® 2D



1.8m from  
£33.00  
Per Metre

Fence Height m	Powder Coated Black Metre Code	PPC Green Metre Code
1.8	56NY2D18BM	56NY2D18GM
2.0	56NY2D20BM	56NY2D20GM
2.4	56NY2D24BM	56NY2D24GM

- Mesh size: 200 x 50mm
- Posts: Twilfix® 2000 system
- Post centres: At approximately 2.525m
- Finish: Powder coated green or black on a pre-galvanised wire

## MeshMaster™ Palex



1.8m from  
£45.00  
Per Metre

Fence Height m	Powder Coated Black Metre Code	PPC Green Metre Code
1.8	–	54PAL18GM
2.0	–	54PAL20GM
2.4	54PAL24BM	54PAL24GM

- Mesh size: Varies to 50 x 50mm max
- Posts: Twilfix® 2000 system
- Post centres: At approximately 2.975m
- Finish: Powder coated green or black on a pre-galvanised wire

## Betafence Securifor® 358

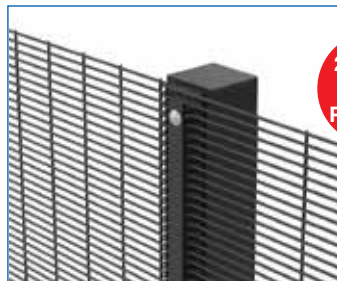

2m from  
£78.00  
Per Metre

Fence Height m	Powder Coated Black Metre Code	PPC Green Metre Code
2.0	56SE35820BM	56SE35820GM
2.4	56SE35824BM	56SE35824GM
3.0	56SE35830BM	56SE35830GM

- Mesh size: 76.2 x 12.7mm
- Posts: Securifor® 358 posts
- Post centres: At approximately 2.44m
- Finish: Powder coated green or black on a pre-galvanised wire

## We stock a full range of pedestrian and vehicular mesh access gates



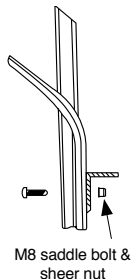
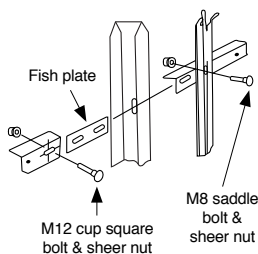
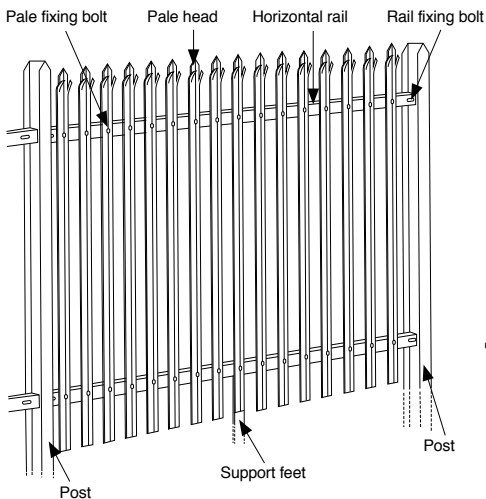
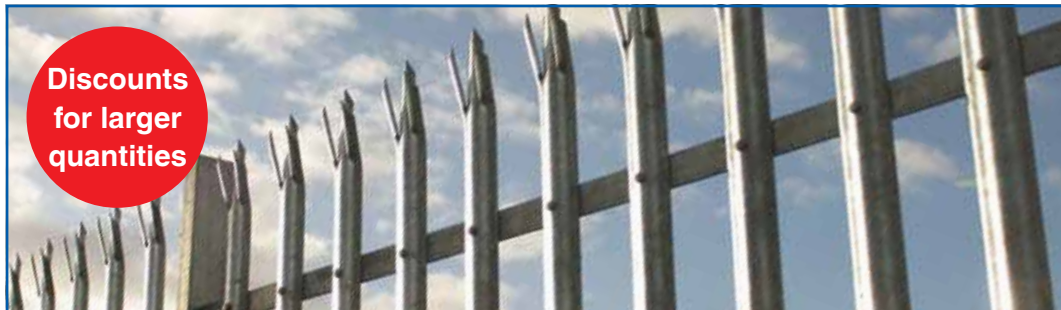

'D' Section Pale



'W' Section Pale



**CONCRETE-IN**

1.8m from  
£59.00  
Per Metre

Also available in bolt-down posts.

Profile	Fence Height m	Metre Code
D	1.8	470218CDM
	2.0	470220CDM
	2.1	470221CDM
	2.4	470224CDM
	3.0	470230CDM
W	1.8	470218CWM
	2.0	470220CWM
	2.1	470221CWM
	2.4	470224CWM
	3.0	470230CWM

## Network Rail Palisade / Track Side

We now stock a range of galvanised palisade fencing with single point pales, to Network Rail specification for installation along trackside.

- Stocked in 1.8m and 2.4m high
- W section single point
- Competitive metre rates
- Gates supplied to suit



# Marano® Aluminium Fencing

Top cap with connect board



Mid post with laser cut screen insert



Mid post with corner post insert



Support kit



Screen with fixing kit

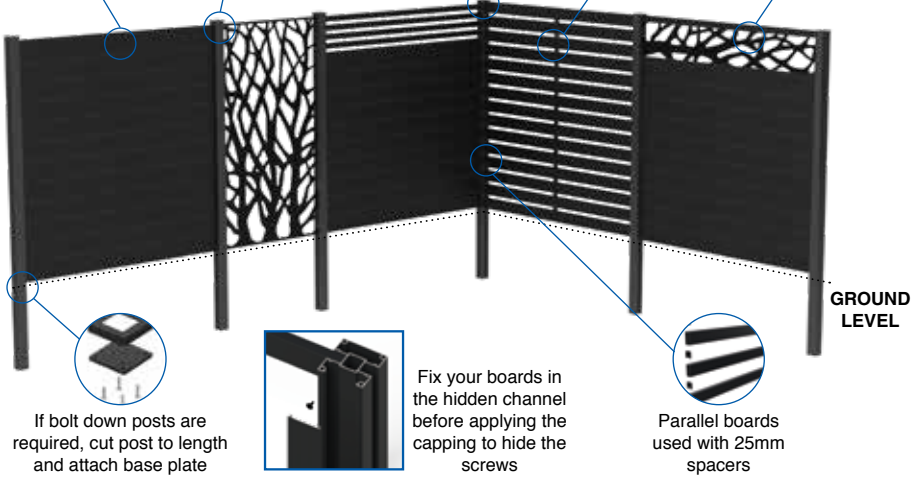

If bolt down posts are required, cut post to length and attach base plate



Fix your boards in the hidden channel before applying the capping to hide the screws

Parallel boards used with 25mm spacers

GROUND LEVEL

Boards are available in 4 powder coated matt finish boards, 2 wood effect boards or alternatively a mill finish, to allow you to powder coat to your preferred choice of RAL colour.

**Basalt Grey**  
RAL 7012

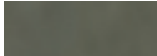

**Pebble Grey**  
RAL 7032



**Beige Grey**  
RAL 7006



**Black Sand**  
RAL 9005

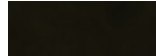

**Oak Wood Effect**



**Grey Wood Effect**



## Board Styles

**Half Round**



**Parallel 50**



**Parallel 100**



**Parallel 150**



**Louvre**



**Ridged**



**Wave**



**Connect 150**



Parallel 50 Board

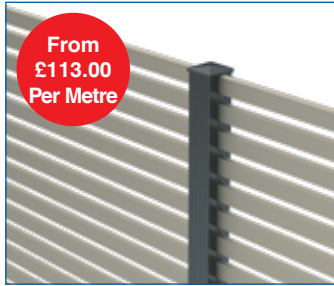

Parallel 100 Board



Wave Board



Ridged Board



Connect 150 Board



Connect 150 with Palm Laser Screen



Steel fabricators and gate makers can incorporate these boards into steel gate frames and rely on the extensive F.H.Brundle range of steel sections, gate hardware and automation to create matching gates specific to customers' requirements.

1825 x 300mm Laser cut screens

Sunburst



Palm

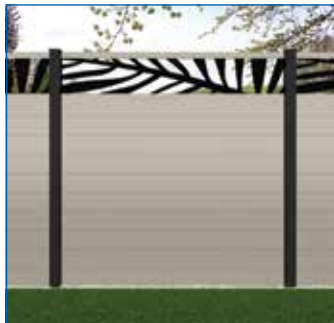

Woodland



For more information on our metre rate prices, FREEPHONE 0808 303 4690

# Fortitude™ Steel Handrailing & Glass

Our most flexible handrailing solution, just became more flexible! As we edge into spring, not only are we implementing significant price reductions to our top-quality Fortitude™ handrailing system, we are also pleased to announce even more innovations to enhance the range.



This steel railing system brings an unparalleled quality to any patio deck or balcony. Giving a clean classic appearance that offers versatility in any residential application. Fortitude™ Contemplation posts and stocked glass panels, provide installers with a stunning glass balustrading solution, which can also be integrated with our traditional system, if you want a few glass panels to improve the view on a specific section of your installation.

## Black Sand 50mm Square Steel Posts - For Use Without Handrail

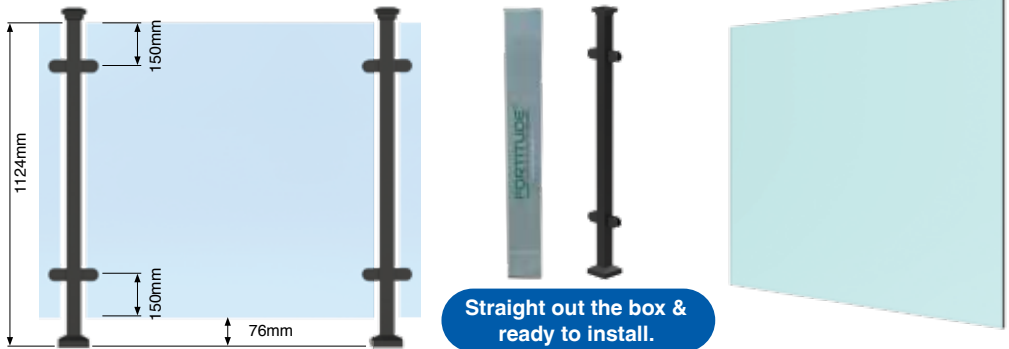

Where no handrail is used, the Contemplation Glass system will not pass BS 6180 loading requirements and should only be used in areas where the fall is no more than 600mm.

## 10 REASONS TO BUY FORTITUDE™ RAILINGS & GLASS

**1** Modular Railing System

**2** Adjustable Panel

**3** Concrete-In Posts

**4** Faster Installations

**5** Fascia-Fix Posts

**6** Enhanced Views

**7** Glass Panels From Stock

**8** Make Instant On-Site Gates

**9** Elegant Appearance

**10** Tested To Relevant British Standards



# Fortitude™ Steel Handrailing & Glass

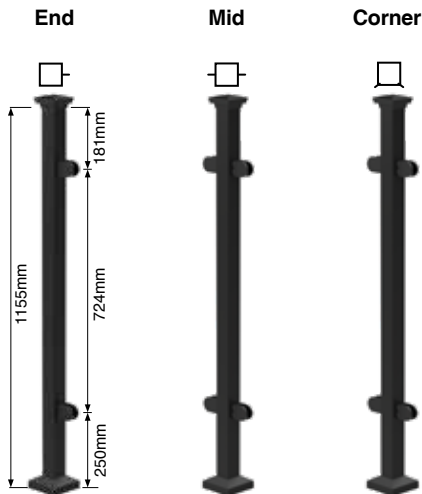

## Glass Panels For Use Without Handrail

1024mm High 10mm Thick

Width mm	Code	Price
100	<b>1855101001024</b>	<b>£15.00</b>
200	<b>1855102001024</b>	<b>£15.00</b>
300	<b>1855103001024</b>	<b>£15.40</b>
400	<b>1855104001024</b>	<b>£20.50</b>
500	<b>1855105001024</b>	<b>£25.70</b>
600	<b>1855106001024</b>	<b>£30.80</b>
700	<b>1855107001024</b>	<b>£35.90</b>
800	<b>1855108001024</b>	<b>£32.00</b>
900	<b>1855109001024</b>	<b>£41.70</b>
1000	<b>18551010001024</b>	<b>£43.80</b>
1100	<b>18551011001024</b>	<b>£51.80</b>

## Multi-Fix Hex Head Bolt



End Code	Mid Code	Corner Code
<b>64PB76150BF</b>	<b>64PB76250BF</b>	<b>64PB76350BF</b>
<b>£54.00</b>	<b>£66.10</b>	<b>£58.50</b>

Size mm	Code
M10 x 75	<b>5002HCS1075</b>
	<b>£0.71</b>

Black sand. 2.3mm thickness. Supplied with base cover plate, glass clamps and pyramid post cap. For fixing bolts use code: **5002HCS1075**.

For fixing to concrete, brick, stone, wood and concrete block. Pack quantity 1.

Bespoke glass panels are also available on request.  
FREEPHONE 0808 303 4690 for more information.

## Capping Handrail System

Our **NEW** 70 x 45mm capping profile is one of the most versatile handrailing systems on the market. Not only is it cost effective, but is also quick and easy to install, with only a single screw needed to secure it to the post. Available in satin anodised, black gloss, or black sand, this handrail is suitable for any 50mm square post.

### Marano® Handrailing Systems

### Fortitude™ Contemplation Post & Glass System

### Fortitude™ Traditional Handrailing System

### Wrought Iron Railings



#### Features:

- Cost effective, quick & easy to install
- Secured by a single bolt through the handrail & into the post
- Connectors can be glued for ease of use
- Suitable for any 50mm square post



# Pro-Railing® Post & Glass Systems



## Satin Polish Ø 42.4mm Posts - For Use Without Handrail

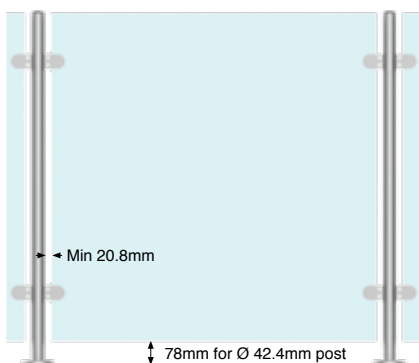

Straight out the box & ready to install.

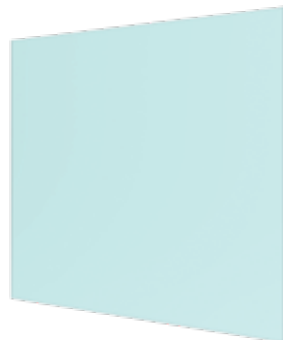

End ○

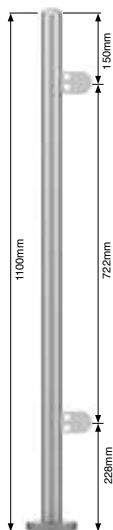

Mid ○



Corner



Satin Finish

Glass Panels  
For Use Without Handrail  
1024mm High 10mm Thick

Width mm	Code	Price
100	1855101001024	£15.00
200	1855102001024	£15.00
300	1855103001024	£15.40
400	1855104001024	£20.50
500	1855105001024	£25.70
600	1855106001024	£30.80
700	1855107001024	£35.90
800	1855108001024	£32.00
900	1855109001024	£41.70
1000	18551010001024	£43.80
1100	18551011001024	£51.80

Multi-Fix Hex Head Bolt  
M10 x 75mm



Code **1806771C** Price **£47.30**

Code **1806772C** Price **£61.10**

Code **1806773C** Price **£62.30**

Code **5002MF10875** Price **£37.90**

Stainless steel Grade 316. Supplied with glass clamps, cover plate and end cap, to give 1100mm high handrail.

For fixing to concrete, brick, stone, wood and concrete block. Pack quantity 100.





## Satin Polish Ø 42.4mm Posts - For Use With Handrail

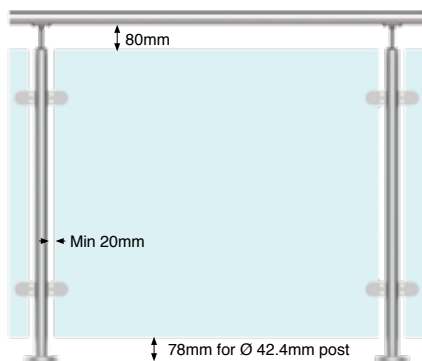

Straight out the box & ready to install.

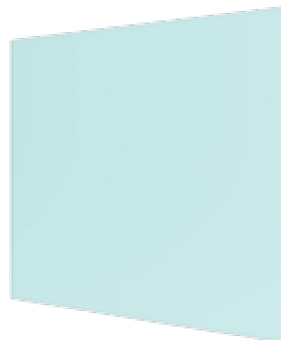

End ○

Mid ○

Corner ⊙

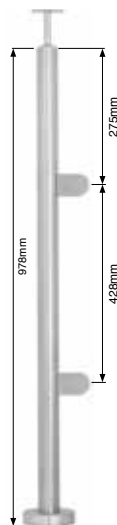

Satin Finish



Glass Panels  
For Use With Handrail  
900mm High 10mm Thick

Width mm	Code	Price
100	185510100900	£15.00
200	185510200900	£15.60
300	185510300900	£15.00
400	185510400900	£17.80
500	185510500900	£22.50
600	185510600900	£27.10
700	185510700900	£25.40
800	185510800900	£37.00
900	185510900900	£32.20
1000	1855101000900	£46.70
1100	1855101100900	£37.70

Ø 42.4mm Tube



**Code** **Price**  
1806731C **£52.80**

**Code** **Price**  
1806732C **£66.60**

**Code** **Price**  
1806733C **£66.10**

**Length m** **Code** **Price**  
5.8 1806701C **£82.70**

Stainless steel Grade 316. Supplied with glass clamps, cover plate and saddle, to give 1100mm high handrail.

# Pro-Railing® Top Rail Systems



**PRO-RAILING**  
The Stainless Steel Handrail Component System

A stylish solution for the top of any glass balustrade.

The largest range of top rails available from stock. Our metre prices include 1 x top rail and 1 x rubber gasket to suit your required glass thickness.

- Systems to suit 8 - 21.50mm glass
- Anodised aluminium, PPC black or stainless steel
- No welding required
- Satin polish or mirror finish
- Choice of 12 profiles including rubber gasket

**Cap Rail - Satin**



**Square Slim - Satin**



**Aluminium**



**Aluminium Square**



**Aluminium Rectangular**



**Aluminium Round**



**Round - Satin**



**Round Mini - Satin**



**Square Mini - Satin**



**Round - Mirror**



**Rectangular - Satin**



**Oval - Satin**





**Satin Finish**



**Mirror Finish**



**PPC Matt Black**



**Flat Back**

Glass mm	Ø mm	Code
10	N/A	05CL1260F304
10	N/A	05CL1260F316

**Flat Back**

Glass mm	Ø mm	Code
10	N/A	05CL1260F316M

**Flat Back**

Glass mm	Ø mm	Code
10	N/A	1805401FB

**Round Back**

10	42.4	05CL1260C304
10	48.3	05CL1260D304
10	42.4	05CL1260C316
10	48.3	05CL1260D316

**Round Back**

10	42.4	05CL1260C316M
10	48.3	05CL1260D316M

**Round Back**

10	42.4	1805401CB
10	48.3	1805401DB

Type 401. Cast aluminium.

Colour Code:

- Stainless steel Grade 304
- Stainless steel Grade 316
- Aluminium

From  
£2.00  
Each

Scan here to shop  
Glass Clamps.



## Useful Components

### Donut cover cap

Fit at time of installation  
To suit Ø 42.4 & 48.3mm posts



### Retro-fit cover cap

Retro-fitted after installation  
To suit Ø 42.4 & 48.3mm posts

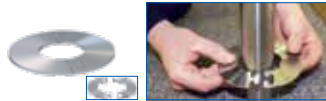

### Extended scroll end

Complies with part M building regulations. To suit Ø 42.4 & 48.3mm tube. 400mm length



### Adjustable internal fit base flange

Ideal for use on stairs & slopes  
+/- 55 degree movement



### Adjustable angle bracket

To suit Ø 42.4 & 48.3mm tube.  
Locked in place with a grub screw



# Pro-Railing® Wedge-Loc™ Slim

Base-Fix



Side-Fix



- Available in satin anodised, PPC black & mill finish
- Stainless cladding not required
- Great value
- Quick & easy to install
- Pre-drilled channel fixing holes
- Suitable for 12 - 21.5mm glass

Image shows a base-fix application

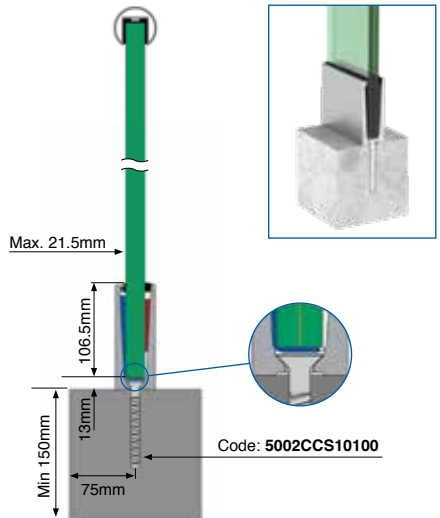

From  
£115.50  
Per Metre\*

\*Guidance price based on using 12mm toughened glass.

# Pro-Railing® Wedge-Loc™ DUO

Image shows a base-fix application

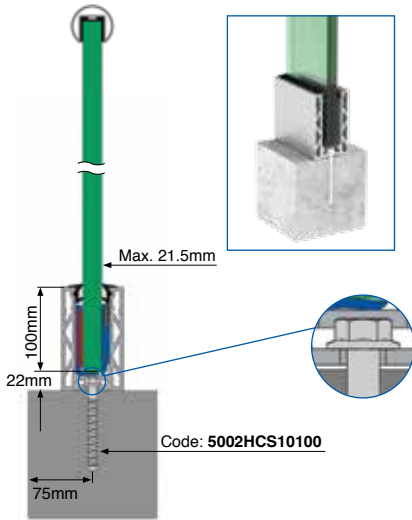

Base-Fix



Side-Fix



- Available in satin anodised and PPC black finish
- Stainless cladding not required
- Wedges allow the quick alignment of glass
- Quick & easy to install
- +/- 1° adjustment on glass using the Flexible Hex Bit
- Suitable for 15 - 21.5mm glass

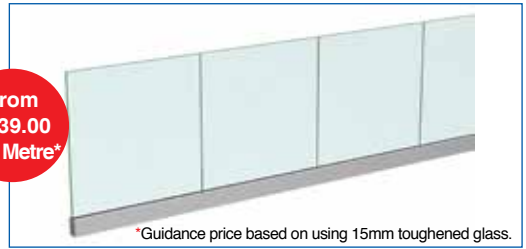

From  
£139.00  
Per Metre\*

\*Guidance price based on using 15mm toughened glass.

Add the perfect finish with one of our many top rails. See page 26.

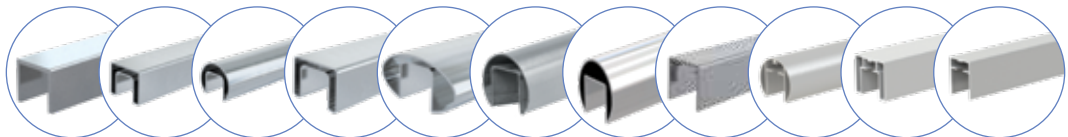

## Base-Fix



- Available in satin anodised and PPC black finish
- For balconies, decking subframes & under new screed
- F profile doesn't require counter-sunk anchors for fixing
- Quick & easy to install
- Pre-drilled channel fixing holes
- Suitable for 12 - 21.5mm glass

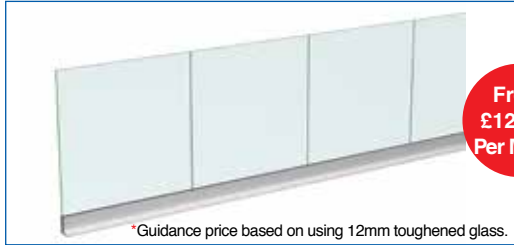

From  
£122.00  
Per Metre\*

\*Guidance price based on using 12mm toughened glass.

## Image shows a base-fix application

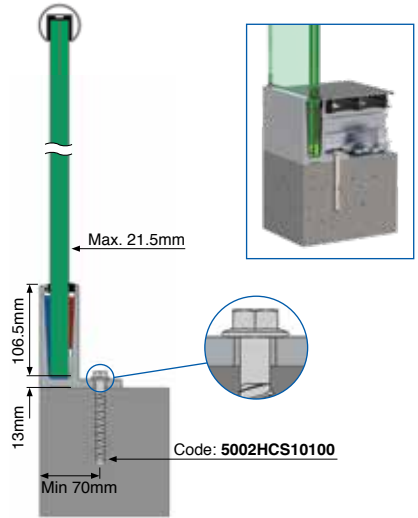

# Pro-Railing® POSglaze

## Image shows a base-fix application

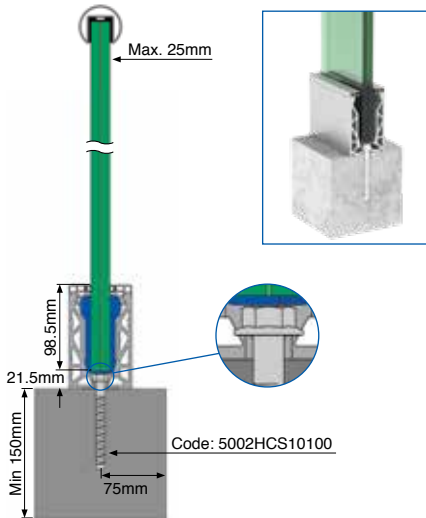

## Base-Fix



## Side-Fix



- Available in satin anodised and PPC black finish
- Simply adjust the bolt screw to align the glass
- Quick & easy alignment of glass panels
- Lightweight & extremely strong
- Suitable for domestic & commercial applications
- Suitable for 12 - 21.5mm glass

From  
£160.50  
Per Metre\*



\*Guidance price based on using 12mm toughened glass.

A full range of fixings are available online.

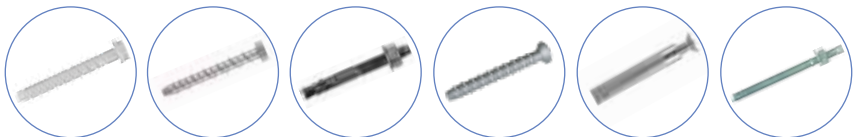

# Handrail Standards



## Handrail Standards

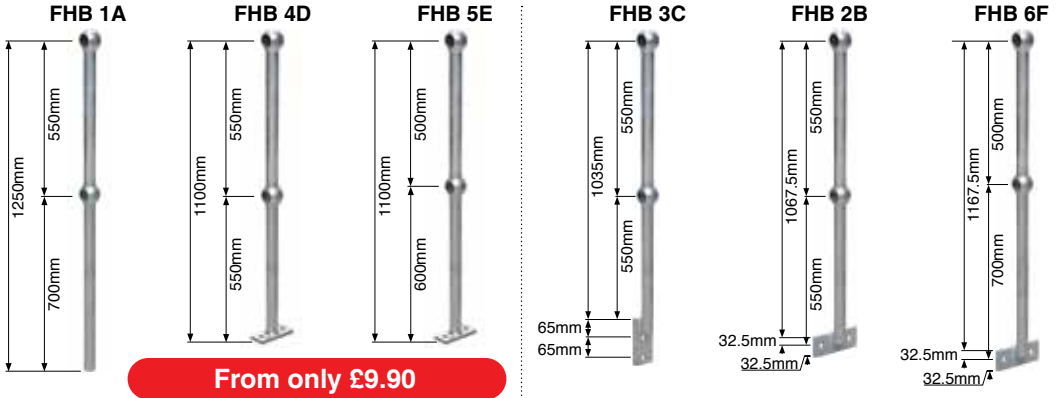

Handrail standard posts come with the following spec:

- Galvanised or mild steel
- Available in Ø 33.7, 42.4 & 48.3mm
- M8 clamping screws fitted to balls
- Other dimensions can be supplied to order

## Handrail Bends

Tubular bends in both galvanised and mild steel for Ø 33.7, 42.4 and 48.3mm tube will do just that. These bends are designed for Handrail Standards, Adjustarail and Tube Clamps. Joining bends to handrail tube couldn't be simpler.

Specification for all bends:

- Galvanised or mild steel
- Available in Ø 33.7, 42.4 & 48.3mm
- 300mm legs

**90° Bend**



**From  
£7.00**

**Adjustarail Return Bend**

500mm centres



**Standard Return Bend**

550mm centres



For our full range of galvanised tube, visit [www.fhbrundle.co.uk](http://www.fhbrundle.co.uk)

# Round Tube Clamp Posts & Fittings

## Round Tube Clamp Posts



Ø 42.4 & 48.3mm

### Double Mesh Panel

For use with a top & mid-rail post



### Single & Double Mesh Clips

For Ø 42.4 & 48.3mm posts



## Round Tube Clamp Fittings

### Short Tee



Type	Code	Price
C	16101C	£3.20
D	16101D	£4.50

### Long Tee



Type	Code	Price
C	16104C	£5.30
D	16104D	£6.90

### Two Socket Cross



Type	Code	Price
C	16119C	£4.10
D	16119D	£5.30

### 90° Elbow



Type	Code	Price
C	16125C	£3.90
D	16125D	£4.50

### Railing Base Flange



Type	Code	Price
C	16132C	£5.90
D	16132D	£7.40

### Internal Joint



Type	Code	Price
C	16150C	£3.30
D	16150D	£3.90

### Stop End



Type	Code	Price
C	16133C	£0.26
D	16133D	£0.26

Single & double  
Splice Locks are  
available online.



## Galvanised Tube

Available as standard galvanised or PPC yellow and black, with a range of lengths from 1.044 - 6.5m, in diameters of 26.9, 33.7, 42.4 and 48.3mm. We have it covered.

Perfect for:

- Handrails
- Safety Barriers
- Awnings and Carports
- Support Structures
- Children's Play Equipment
- Market Stalls
- Exhibition Stands
- Temporary Buildings
- Lighting Grids
- Pallet or Garment Racking



For our best prices visit [www.fhbrundle.co.uk](http://www.fhbrundle.co.uk)

# GRP Gratings & Stair Treads



- Top quality
- Corrosion resistant
- Slip resistant
- Fire retardant
- High weight to strength ratio
- Easy to use
- Long service life
- Integral quartz grit top

All specs below are 38mm square grating with a 38mm depth.

## Green

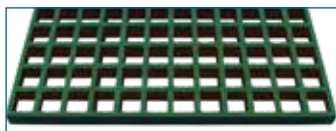

Panel Size mm	Code	Price
996 x 1985	33213838GN	£142.30
996 x 3010	33313838GN	£207.70
1220 x 3660	3336123838GN	£325.60

## Green With Yellow Gritted Nosing

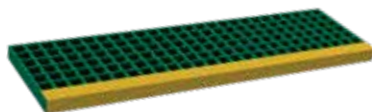

Panel Size mm	Code	Price
996 x 275	331027538GN	£43.90
1220 x 275	331227538GN	£36.40

## Grey



Panel Size mm	Code	Price
996 x 1985	33213838GY	£140.30
996 x 3010	33313838GY	£205.40
1220 x 3660	3336123838GY	£306.90

## Grey With Yellow Gritted Nosing

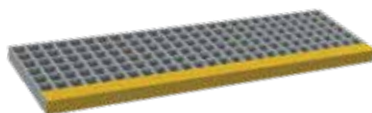

Panel Size mm	Code	Price
996 x 275	331027538GY	£33.20
1220 x 275	331227538GY	£43.60

## Yellow

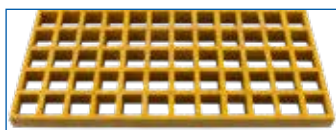

Panel Size mm	Code	Price
996 x 1985	33213838Y	£138.60
996 x 3010	33313838Y	£199.20
1220 x 3660	3336123838Y	£361.20

## Yellow With Black Gritted Nosing



Panel Size mm	Code	Price
996 x 275	331027538Y	£40.40
1220 x 275	331227538Y	£47.40





## Open Steel Stair Treads 41/100

Perforated nosing for extra grip

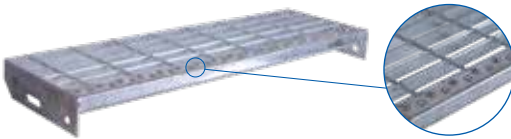

W x D x H x T mm	Code	Price
800 x 247 x 25 x 5	<b>441208242A</b>	<b>£20.10</b>
800 x 288 x 25 x 5	<b>441208283A</b>	<b>£22.20</b>
900 x 247 x 25 x 5	<b>441209242A</b>	<b>£21.80</b>
900 x 288 x 25 x 5	<b>441209283A</b>	<b>£24.10</b>
1000 x 247 x 25 x 5	<b>441210242A</b>	<b>£23.60</b>
1000 x 288 x 25 x 5	<b>441210283A</b>	<b>£26.10</b>
1200 x 288 x 25 x 5	<b>441212283A</b>	<b>£30.00</b>

Galvanised.

## CUBE Stair Treads

Oyster-surface between meshes for slip resistance

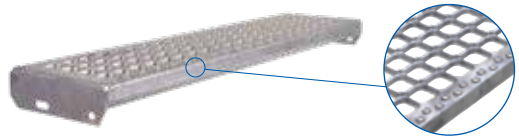

W x D x H x T mm	Code	Price
800 x 240 x 42 x 2	<b>4412CB08240</b>	<b>£25.20</b>
1000 x 240 x 42 x 2	<b>4412CB10240</b>	<b>£29.50</b>
1200 x 240 x 52 x 2	<b>4412CB12240</b>	<b>£35.40</b>
800 x 270 x 47 x 2	<b>4412CB08270</b>	<b>£33.30</b>
900 x 270 x 47 x 2	<b>4412CB09270</b>	<b>£36.30</b>
1000 x 270 x 47 x 2	<b>4412CB10270</b>	<b>£39.40</b>
1200 x 270 x 52 x 2	<b>4412CB12270</b>	<b>£46.10</b>
1200 x 300 x 57 x 2	<b>4412CB12305</b>	<b>£40.90</b>
1000 x 305 x 42 x 2	<b>4412CB10305</b>	<b>£34.20</b>

Galvanised.

## Mild Steel Stair Treads



W x L x T mm	Code	Price
800 x 265 x 4.5	<b>44011A</b>	<b>£19.90</b>
900 x 265 x 4.5	<b>44012A</b>	<b>£21.90</b>
1000 x 265 x 4.5	<b>44001A</b>	<b>£24.10</b>
1250 x 265 x 4.5	<b>44002A</b>	<b>£29.70</b>

40mm turn up / down.

## Aluminium Chequer Plate



W x L x T mm	Code	Price
2000 x 1000 x 1.5	<b>35052115</b>	<b>£50.20</b>
2000 x 1000 x 2.0	<b>3505212</b>	<b>£66.20</b>
2500 x 1250 x 1.5	<b>350584515</b>	<b>£78.00</b>

## Galvanised Stair Treads



W x L x T mm	Code	Price
800 x 265 x 4.5	<b>44011TA</b>	<b>£32.60</b>
900 x 265 x 4.5	<b>44012TA</b>	<b>£35.90</b>
1000 x 265 x 4.5	<b>44001TA</b>	<b>£39.20</b>

40mm turn up / down.

## Mild Steel Floor Plates



W x L x T mm	Code	Price
2000 x 1000 x 4.5	<b>350163145A</b>	<b>£126.90</b>
2500 x 1250 x 4.5	<b>350184145A</b>	<b>£178.50</b>

## Vertical Access Ladder Kits & Accessories



**Original Ladder Kit**  
With 20mm round bar rungs

Rise Size mm	Code	Price
2000 - 2300	<b>25AX2000</b>	<b>£738.00</b>
2400 - 2700	<b>25AX2500</b>	<b>£783.00</b>
2800 - 3200	<b>25AX3000</b>	<b>£918.00</b>
3300 - 3800	<b>25AX3500</b>	<b>£1,146.00</b>
3900 - 4300	<b>25AX4000</b>	<b>£1,227.00</b>
4400 - 5200	<b>25AX4500</b>	<b>£1,279.50</b>
5300 - 6000	<b>25AX5500</b>	<b>£1,635.00</b>

### Ladder Security Plate

Supplied with fixing bolts



H x W mm	Code	Price
2000 x 415	<b>25AXLSP01</b>	<b>£207.80</b>

Lock not included.

### Universal Self-Closing Half Gate

Supplied with fixing bolts

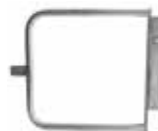

Height mm	Code	Price
550	<b>25AXSG04</b>	<b>£115.50</b>



Scan for individual ladder components.



## Spin Guard

Per Metre



Length m	Code	Price
1	<b>400001C</b>	<b>£37.30</b>

Includes vanes, shafts and internal connectors. Does not include brackets.

Bent Over Arm Bracket



Height mm	Code	Price
570	<b>400004</b>	<b>£9.00</b>

For bolting to posts or side of wall.



Crash barriers are used in vehicle parks, factories and industrial premises to protect people, property and plant installations from the dangers of impact by vehicles, and to minimise expensive repairs, and consequential losses from such accidents.

## Beams



Nominal Length mm	Code	Price
1600	120116	£49.90
3200	120132	£86.70

## Beam Converter



Nominal Length mm	Code	Price
1316	120134	£72.50

Convert a single beam into a double beam.

## Fish Tail

Adds 392mm



Length mm	Code	Price
700	120301	£38.50

## Bolt-Down Sprung

For single beam



Height mm	Code
610	120101B
<b>£56.30</b>	

## Bolt-Down I

For single beam



Height mm	Code
760	120202B
<b>£45.50</b>	

## Bolt-Down Z

For single beam



Height mm	Code
760	120402
<b>£23.00</b>	

## Concrete-In I

For single beam



Height mm	Code
1200	120212B
<b>£38.70</b>	

## Concrete-In Z

For single beam



Height mm	Code
1200	120412
<b>£25.80</b>	

## External 90°

Adds 288mm

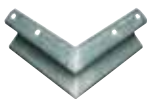

Length mm	Code
500	120303
<b>£43.70</b>	

## End Protector



Colour	Code
Yellow	120305
<b>£15.10</b>	

Rubber.

## Scroll End

Adds 138mm



Length mm	Code
446	120306
<b>£42.10</b>	

## Fish Tail End

With yellow reflectors



Colour	Code
Yellow	120313Y
<b>£34.60</b>	

Polymer.

# F.H. BRUNDLE

SERVING THE TRADE SINCE 1889



Dunivaig Road  
Queenslie Ind. Est.  
Queenslie  
Glasgow  
G33 4TP

**Tel: 0141 773 6699**  
**Fax: 0141 773 6633**

Unit B  
Spectrum 23  
Sankey Valley Ind. Est.  
Newton-le-Willows  
WA12 8DN

**Tel: 01942 86 88 88**  
**Fax: 01942 86 88 99**

Middlemore Ind. Est.  
Middlemore Road  
Smethwick  
Birmingham  
B66 2EP

**Tel: 0121 565 8282**  
**Fax: 0121 565 8292**

Alexandra Industrial Est.  
Wentloog Road  
Rumney  
Cardiff  
CF3 1EY

**Tel: 029 2280 1180**

**NATIONWIDE  
SERVICE**



Condor Road  
Quarry Hill Ind. Est.  
Ilkeston  
Derbyshire  
DE7 4RE

**Tel: 0115 930 2070**  
**Fax: 0115 951 2455**

Lamson Road  
Ferry Lane North  
Rainham  
Essex  
RM13 9YY

**Tel: 01708 25 35 45**  
**Fax: 01708 25 35 50**

502 Millbrook Road  
Third Avenue  
Millbrook  
Southampton  
Hants SO15 0JX

**Tel: 023 8070 3333**  
**Fax: 023 8070 5555**



Wrought Iron Components



Perforated Metal



Expanded Metal



Welded Wire Mesh



Woven Wire Mesh



Gate Hardware



Gate Automation



Flooring & Stair Treads



Steel Section



Sliding Door Gear



Handrailing & Components



Fixings & Tools



Tube Clamps



Crash Barrier



Gates & Railings



Fencing & Security



Cantilever Gate Components



Working at Height

Whilst every effort has been made to ensure the accuracy of the information supplied, F.H.Brundle cannot be held responsible for any errors or omissions. The Company reserves the right to withdraw the promotion at any time without notice.

Valid until 29/02/2024.